

Fire Alarm Control Panel

Installation Manual



Disclaimer

In no event shall The Manufacturer be liable for any damages or injury of any nature or kind, no matter how caused, that arise from the use of the equipment referred to in this manual.

Strict compliance with the safety procedures set out and referred to in this manual, and extreme care in the handling or use of the equipment, are essential to avoid or minimise the chance of personal injury or damage to the equipment.

The information, figures, illustrations, tables, specifications, and schematics contained in this manual are believed to be correct and accurate as at the date of publication or revision. However, no representation or warranty with respect to such correctness or accuracy is given or implied and The Manufacturer will not, under any circumstances, be liable to any person or corporation for any loss or damages incurred in connection with the use of this manual. The information, figures, illustrations, tables, specifications, and schematics contained in this manual are subject to change without notice.

Unauthorised modifications to the fire detection system or its installation are not permitted, as these may give rise to unacceptable health and safety hazards.

By installing this equipment on a computer network, the owner accepts full and unequivocal responsibility for ensuring that it is protected against all cyber threats and illegal tampering during the lifetime of the equipment.

Any software forming part of this equipment should be used only for the purposes for which The Company supplied it. The user shall undertake no changes, modifications, conversions, translations into another computer language, or copies (except for a necessary backup copy).

In no event shall The Manufacturer be liable for any equipment malfunction or damages whatsoever, including (without limitation) incidental, direct, indirect, special, and consequential damages, damages for loss of business profits, business interruption, loss of business information, or other pecuniary loss, resulting from any violation of the above prohibitions.

Section 1	
Hardware Overview	6
Hardware Features	6
Fascia	7
Touch-Panel-Display	7
Left-Panel Indicators	8
Right-Panel Indicators	8
Fire In Zone Indicators	9
Printer	9
Main Back Board	10
Ribbon Cable Connectors	11
Sounder and AUX 24V Terminals	12
Relay Terminals	13
Dual-Slot-Connectors	14
Circuit Board Slots and Field Terminals	15
Cable-Tie-Holders	18
Network, RS485 I/O, Fire Routing O/P and Prog I/P	20
Power Supply Terminals	21
0V Terminals	22
Power Supply Fault Signalling Connector	23
Monitored Input and Output Terminals	24
Extension Board	25
LCD Main Processor Board	26
Required Circuit Boards	28
System Board A Module	29
System Board B Module	30
Dual Loop Module	31
Optional Circuit Boards and Assemblies	32
Zone LED Board	33
Vision Unit.	34
Power Supplies	36
Functional Features	39
Section 2	
Installation	42
General Installation Checklist	42
Before You Begin	43
Installing the Fire Alarm Control Panel	46
Replacing Cabinet Components	52
Field Wiring	52
Power Supplies	53
Connecting 24V and Host I/F Wiring	54
Supplementary Power Supply	59
Circuit Boards	60
Installing Circuit Boards	62
Optional Circuit Boards DIP Switch Settings	63
DIP Switch Settings	64
Loop Circuit Boards DIP Switch Settings	64
Field Terminal Assignments	65
Connecting Loop Circuits	67
Connecting Spur Circuits	68
Installing Addressable Devices	69
Detection Loop Sounders and Output Boards	69
Connecting Sounder Circuits	69
AUX 24V 1 and AUX 24V 2	71
Relay Contacts	71
Fire Routing O/P	72
Programmable Inputs	73

Operating and installing the Printer	74
Installing Standby-Batteries	75
Section 3	
Commissioning	77
Power Supply Checks	77
Confirming Operation	77
Fire System Normal Test	78
Panel Tests	78
Lamp & Buzzer Test	78
Display Test	79
System Information	80
Event Log	82
Section 4	
Panel Maintenance	83
Maintenance	83
Cleaning the Touch Screen Display	83
Cleaning the Control Panel Enclosure	83
Inspecting Batteries	84
Replacing Standby-Batteries	84
Removing the Standby-Batteries	84
Installing the Standby-Batteries	84
Replacing Fuses	86
Removing the Fuse	87
Installing the Replacement Fuse	88
ChassisReplacing Internal Components	89
Internal Component Connections 2 to 8 loop	94
Internal Component Connections 2 to16 loop	95
Appendix A	
Specifications	96
Electrical	96
AC Line Ratings	96
Power Supply	96
System Power	98
Standby-Battery Loads	101
Loop Cabling	102
Detection Loop Ratings	103
AUX 24V (1) and (2)	104
Relay Ratings	104
Network RS485 I/O	104
Fire Routing Serial I/O	105
Fire Routing O/P	105
Fault Routing O/P	106
Prog I/P 1, 2 and 3	106
System Components	106
Mechanical	108
Cabinet Components	108
Cabinet Housing	108
Operating Environment	109
Required Circuit Boards	110
System Board A Module	110
System Board B ModuleFACP	110
Supplementary Devices	112
Vision Unit	112

Appendix B	
Calculations	114
Current-Loading	114
Determining the Total Load Current	115
Selecting Standby Batteries	116
Appendix C	
Compatible Standby Batteries	122

Section 1

Hardware Overview

The 2 to 8 Loop version of the panel provides connections for addressable devices up to 8 loops (4 loop cards fitted).

The 2 to 16 Loop version of the panel provides connections for addressable devices up to 16 loops (8 loop cards fitted).

Networked models of the FACP can support over 260,000 addressable devices and 65,000 programmable inputs and outputs. Individual models of the FACP can support up to 2032 addressable points and 512 additional programmable inputs and outputs.

The FACP'S are third party approved to the required European product standards EN54-2 and EN54-4.

This manual contains many illustrations and descriptions of circuit board connectors. Circuit board connectors appearing in illustrations, but not described in the manual are intended for manufacturing purposes only.

Hardware Features

The figure below illustrates hardware features of the FACP:

Figure 1-1
Hardware Features

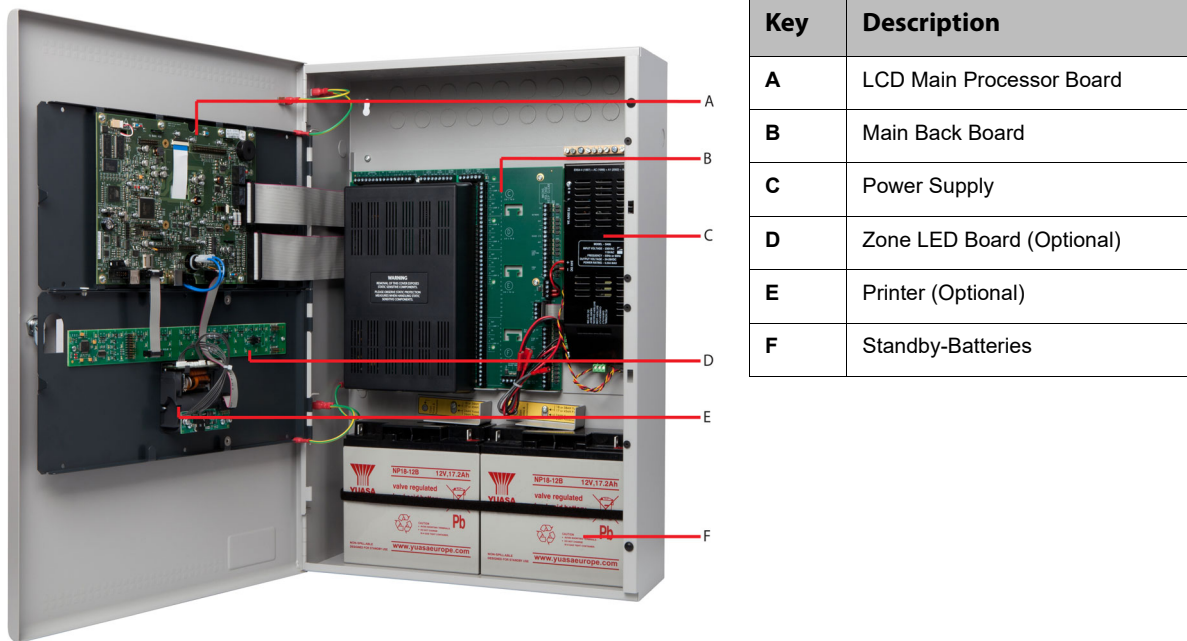

Key	Description
A	LCD Main Processor Board
B	Main Back Board
C	Power Supply
D	Zone LED Board (Optional)
E	Printer (Optional)
F	Standby-Batteries

Note: This image shows the yellow marine battery clamps fitted.

Fascia

The figure below illustrates the fascia of the FACP:

Figure 1-1
Fascia

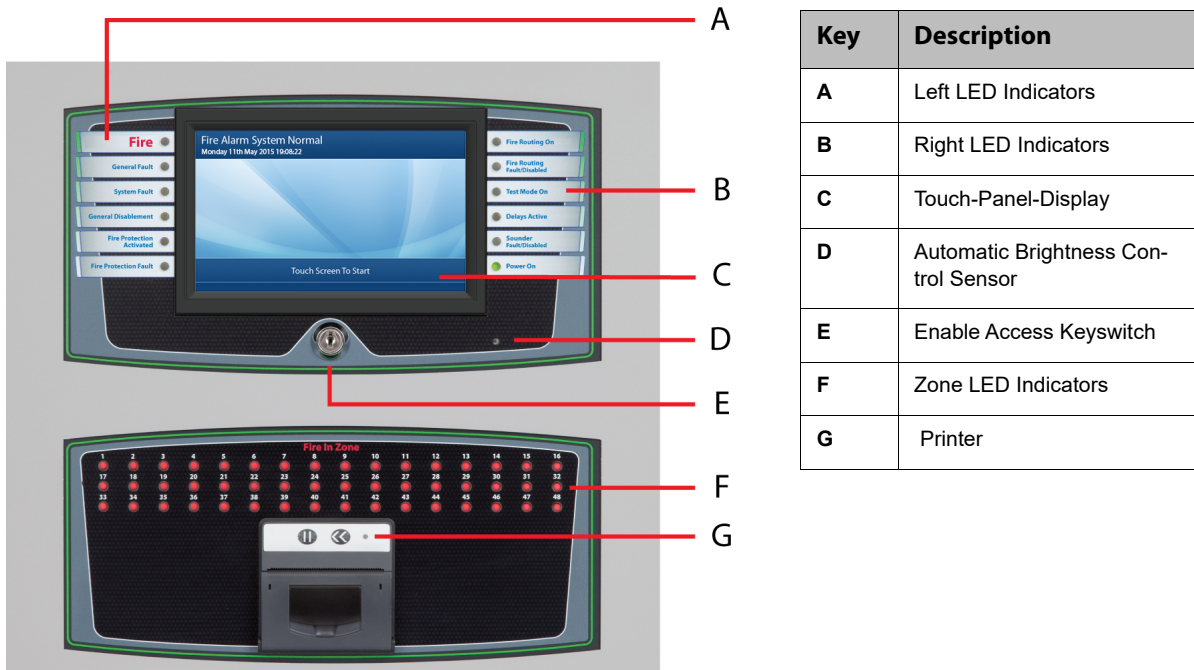

Touch-Panel-Display

The figure below illustrates the normal-standby-condition of the touch-panel-display:

Figure 1-2
Normal-Standby-Condition of Touch-Panel-Display

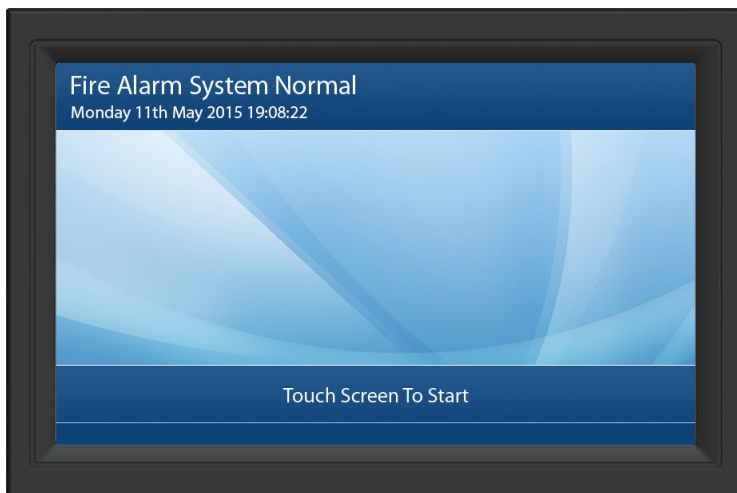

The 7 inch, full colour, high resolution display provides a resistive touch screen that allows operation when users are wearing gloves.

Left-Panel Indicators

The figure below illustrates left-panel indicators:

Figure 1-3
Left-Panel-Indicators



Key	LED Indicator	Illuminated Colour
A	Fire	Red
B	General Fault	Amber
C	System Fault	Amber
D	General Disablement	Amber
E	Fire Protection Activated	Red
F	Fire Protection Fault	Amber

Right-Panel Indicators

The figure below illustrates right-panel indicators:

Figure 1-4
Right-Panel-Indicators



Key	LED Indicator	Illuminated Colour
A	Fire Routing On	Red
B	Fire Routing Fault/Disabled	Amber
C	Test Mode On	Amber
D	Delays Active	Amber
E	Sounder Fault/Disabled	Amber
F	Power On	Green

Fire In Zone Indicators

Fire In Zone indicators are provided on the fascia of the FACP in single, two or three bank configurations. Single bank configurations contain 48 Fire In Zone indicators. Two bank configurations contain 96 Fire In Zone indicators and three bank configurations contain 144 Fire In Zone indicators.

The figure below illustrates a single bank of 48 Fire In Zone indicators:

Figure 1-5
Single Bank of Fire In Zone Indicators



Printer

The Printer is an optional feature located on the lower portion of the fascia. The Printer is a thermal printer that never requires replacement ink. It uses 58 mm wide heat sensitive paper rolls accessible from the fascia of the FACP. The Printer receives power during the printing cycle to reduce power consumption of the standby batteries.

The figure below illustrates the optional front loading, thermal Printer of the FACP:

Figure 1-6
Printer

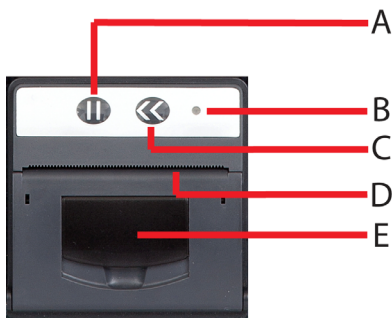

Key	LED Indicator
A	Paper Pause
B	Power LED
C	Paper Feed
D	Paper Exit
E	Paper-Roll Lid Access

Main Back Board

The Main Back Board of the FACP provides slot-connections for optional and required circuit boards as well as for field wiring and power supply terminations.

The figure below illustrates connection properties of the Main Back Board:

Figure 1-7
Main Back Board

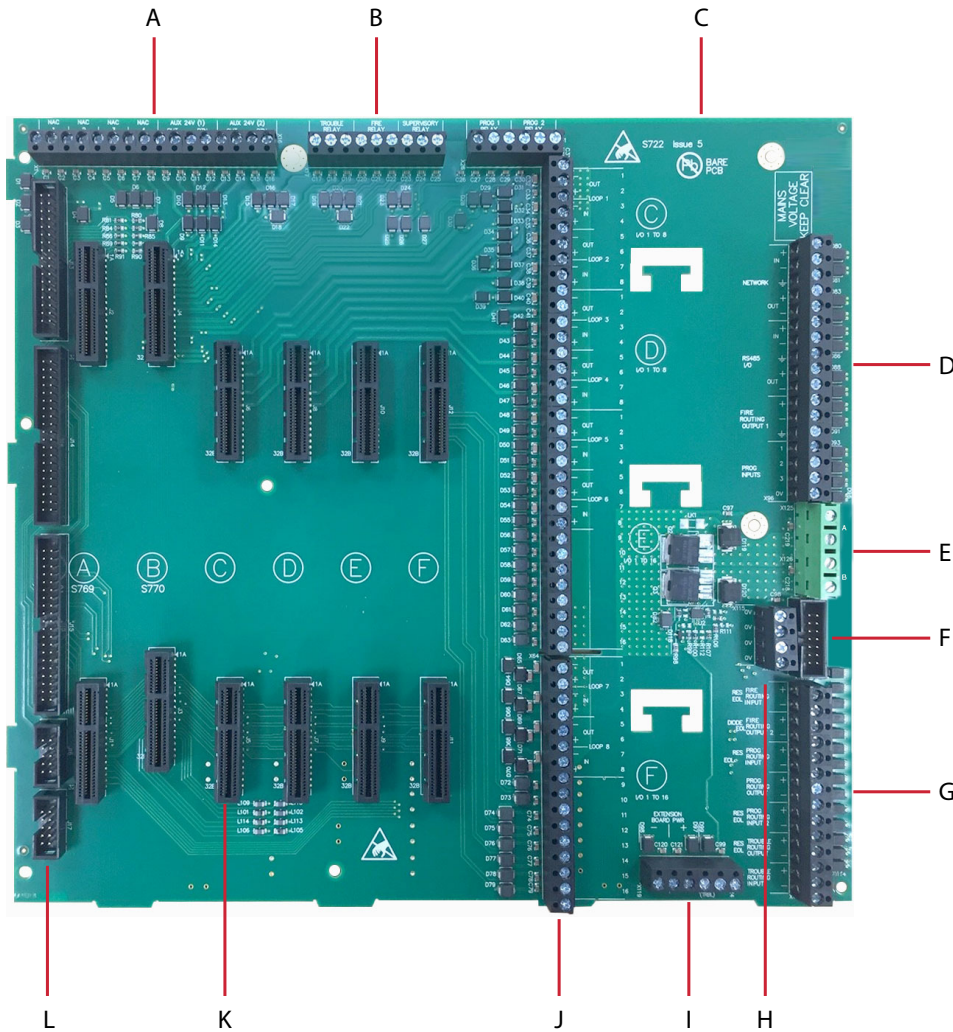

Key	Description
A	Sounder and AUX 24V terminals
B	Relay terminals
C	Cable-tie-holders
D	Network, RS485 I/O bus and Fire Routing interface terminals.
E	Internal and external power supply terminals
F	Power supply fault status signal terminals

Key	Description
G	Monitored input and output terminals
H	General purpose, non-supervised terminals for triggering programmable inputs
I	These terminals are used for factory wiring purposes only
J	Detection loop and I/O terminals
K	Board Slots
L	Ribbon cable connectors.

Ribbon Cable Connectors

The figure below illustrates Ribbon Cable Connectors of the Main Back Board:

Figure 1-8
Ribbon Cable Connectors

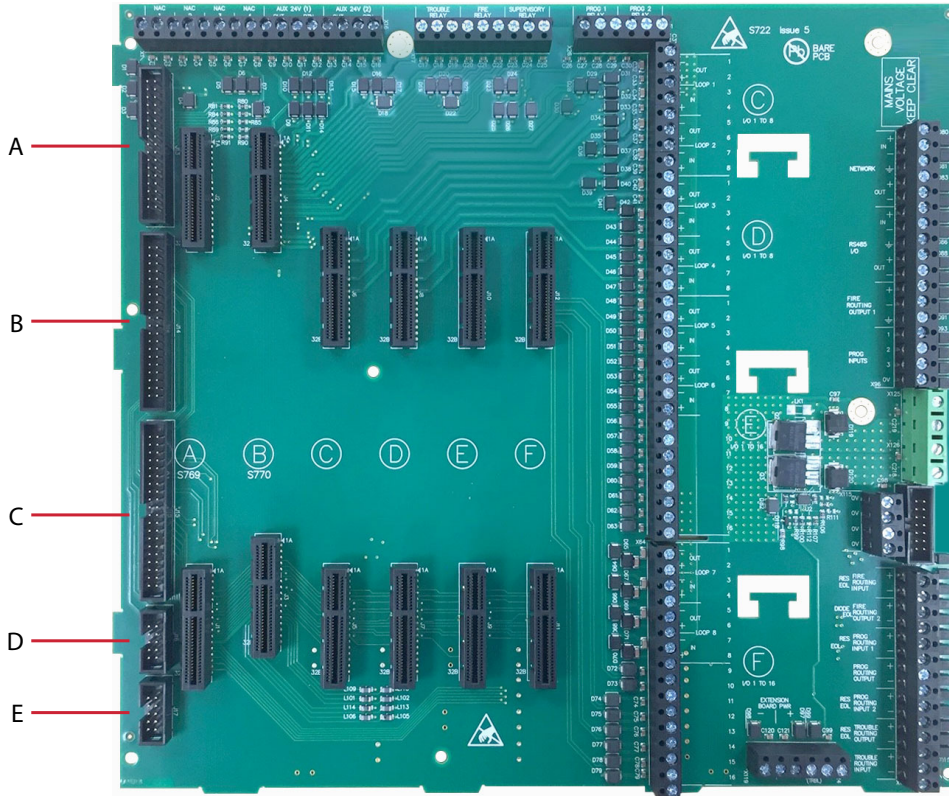

Key	Description
A	LCD Main Processor Board Connector (J13)
B	LCD Main Processor Board Connector (J14)
C	4 Slot Extension Board Connector (J15)

Key	Description
D	Ancillary RS232 Bus 1 Connector (J16)
E	Ancillary RS232 Bus 2 Connector (J17)

Sounder and AUX 24V Terminals

Sounder circuits 1 to 4, in the default state, these sounder circuits can be connected as four spur monitored outputs. Sounder circuits 1 to 4 can also be configured as two Loop or two spur and one loop output.

The figure below illustrates the Sounder and AUX 24V Terminals of the Main Back Board:

Figure 1-9
Sounder and AUX 24V terminals

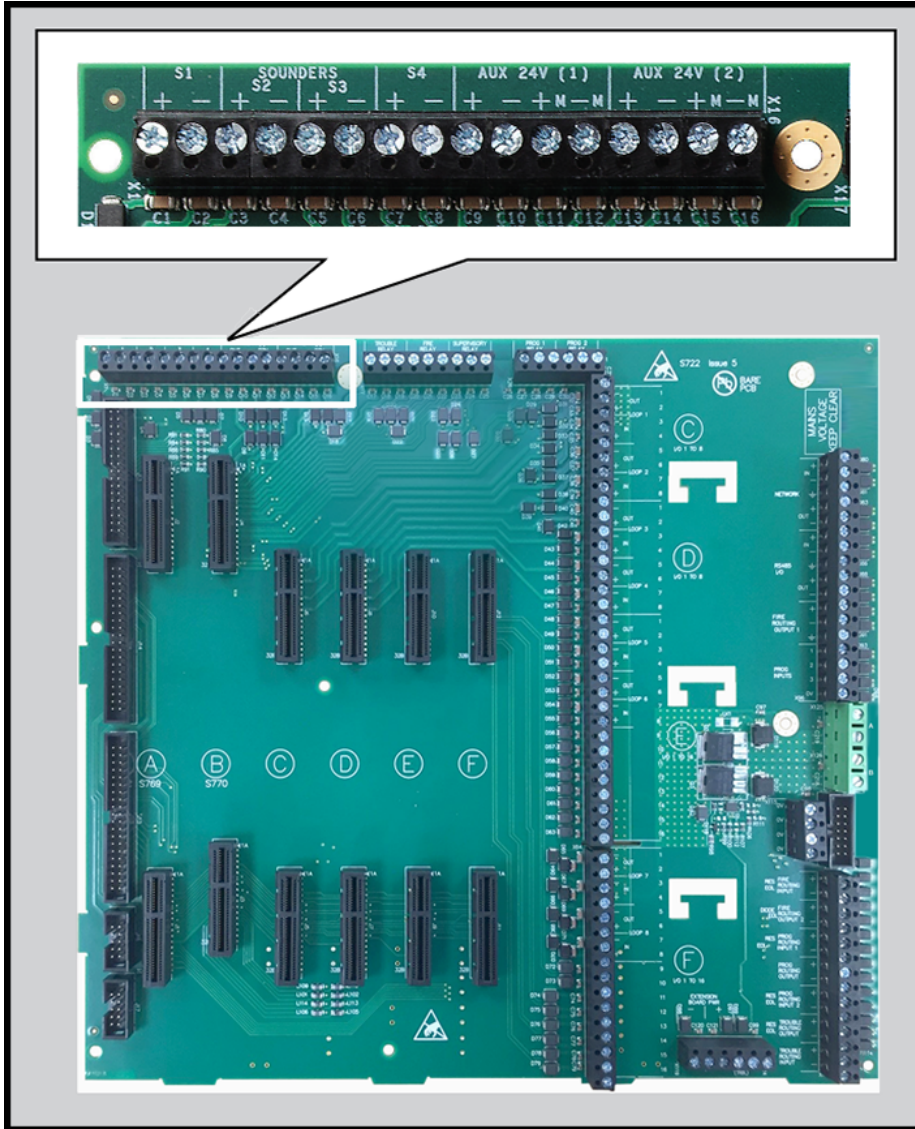

Sounder Field Terminals	Description
(+) and (-)	S1 Sounder Terminals S2 Sounder Terminals S3 Sounder Terminals S4 Sounder Terminals

AUX Field Terminals	Description
(+) and (-)	AUX 24V (1)
(+M) and (-M)	AUX 24V (1) Wiring Monitoring
(+) and (-)	AUX 24V (2)
(+M) and (-M)	AUX 24V (2) Wiring Monitoring

Relay Terminals

The figure below illustrates Relay Terminals of the Main Back Board:

Figure 1-10
Relay Terminals

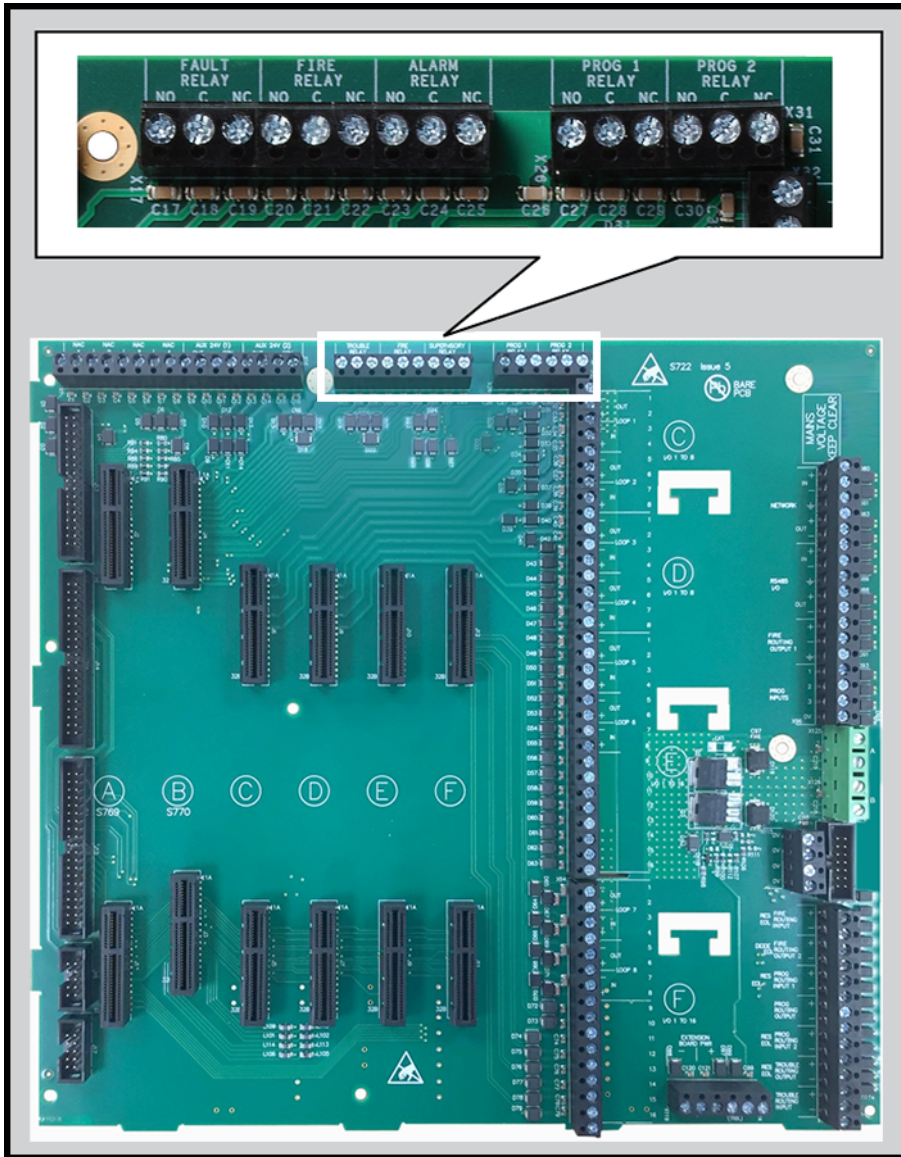

Field Terminals	Description
NO, C and NC	Fault Relay
NO, C and NC	Fire Relay
NO, C and NC	Alarm Relay

Field Terminals	Description
NO, C and NC	Prog 1 Relay
NO, C and NC	Prog 2 Relay

Dual-Slot-Connectors

The figure below illustrates Dual-Slot-Connectors of the Main Back Board:

Figure 1-11
Dual-Slot-Connectors

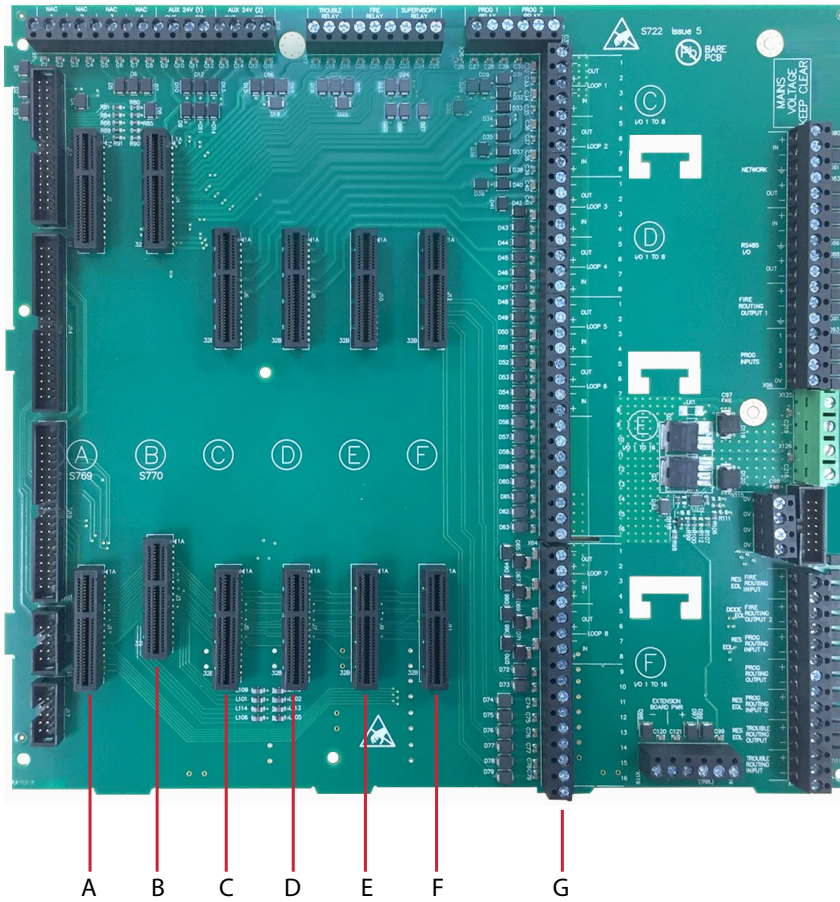

Key	Description
A	Slot A for System Board A Module
B	Slot B for System Board B Module
C	Slot C for Dual Loop Module or I/O Modules
D	Slot D for Dual Loop Module or I/O Modules

Key	Description
E	Slot E for Dual Loop Module or I/O Modules
F	Slot F for Dual Loop Module, I/O Modules or Media Gateway Card
G	Field wiring terminals for Detection Loop Devices or I/O Modules corresponding to slots C, D, E and F.

Circuit Board Slots and Field Terminals

Circuit Board slots A and B are dedicated system boards that operate control panel primary functions.

Circuit board slots and field terminals contain corresponding lettering to identify position on the Main Back Board. Circuit Board slots C,D,E and F correspond with terminals C,D,E and F on the Main Back Board.

The figure below illustrates corresponding lettering of circuit board slots and field terminals of the Main Back Board:

Figure 1-12
Circuit Board Slots and Field Terminals

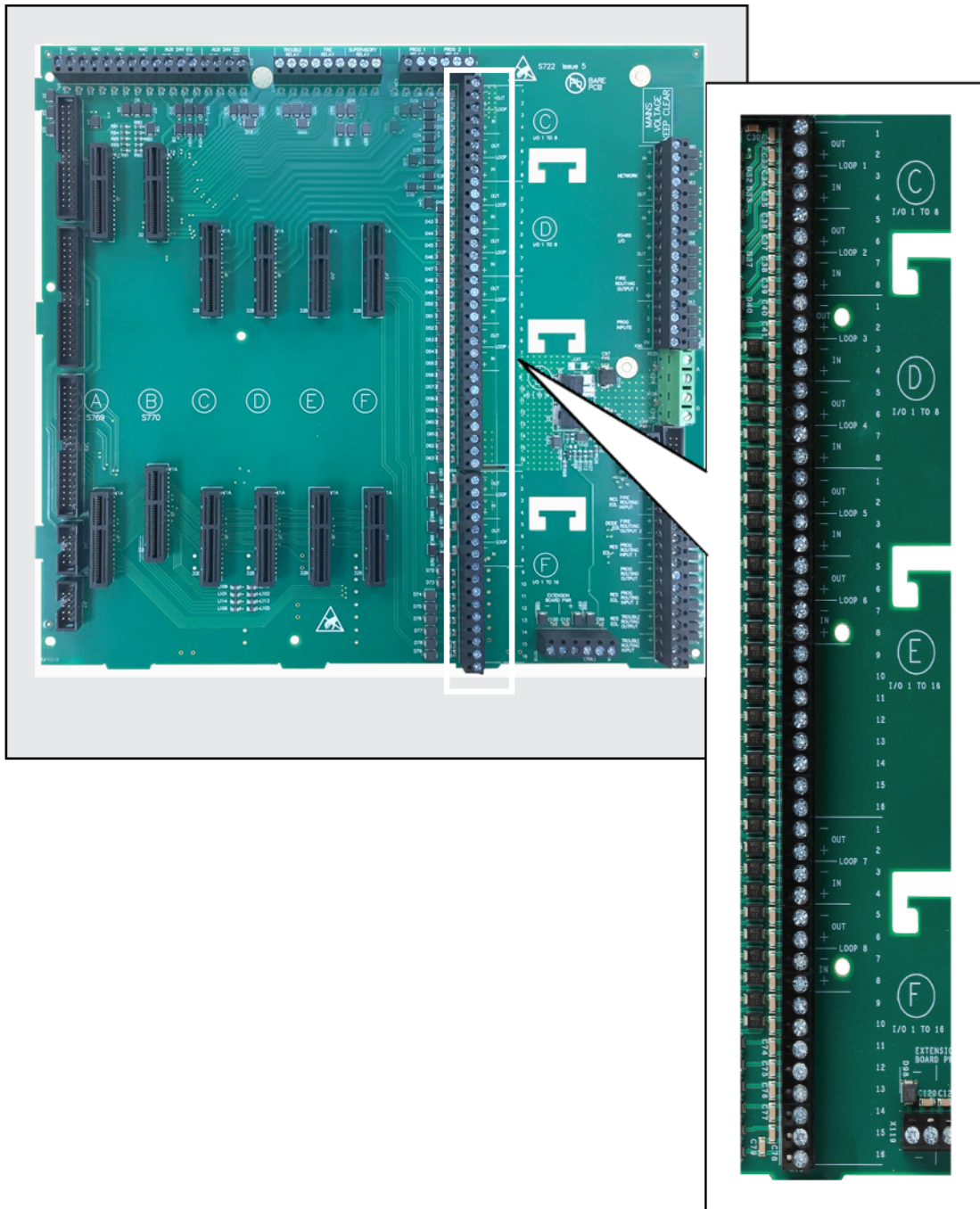

Board Slot C

The figure below illustrates the Board Slot C Terminals of Loops 1 and 2:

Figure 1-13
Board Slot C Terminals of Loops 1 and 2

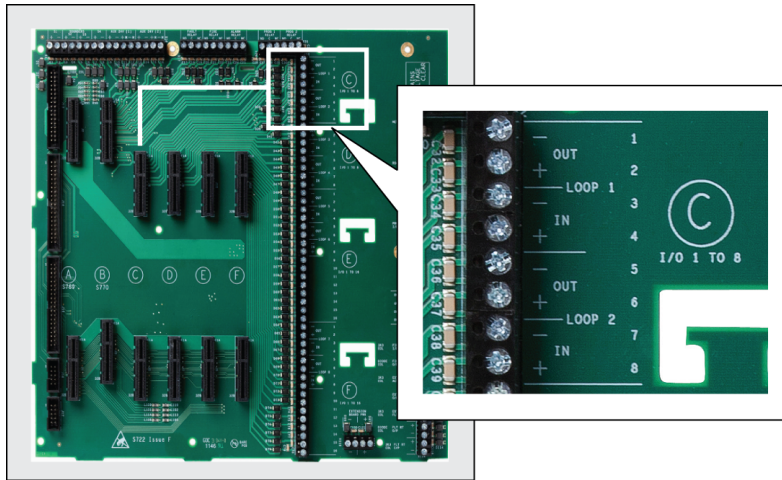

Field Terminals	Board Location	Function
1 - 4 and 5 - 8	Slot C	Loop 1 and Loop 2 or I/O

Board Slot D

The figure below illustrates the Board Slot D Terminals of Loops 3 and 4:

Figure 1-14
Board Slot D Terminals of Loops 3 and 4

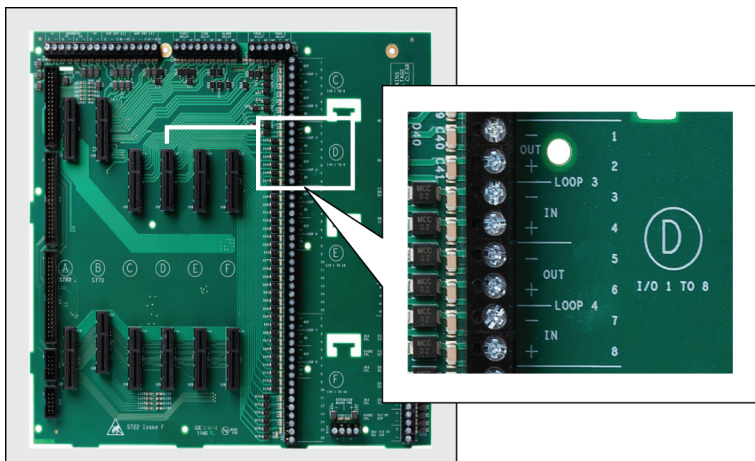

Field Terminals	Board Location	Function
1 - 4 and 5 - 8	Slot D	Loop 3 and Loop 4 or I/O

Board Slot E

The figure below illustrates the Board Slot E Terminals of Loops 5, 6 and I/O:

Figure 1-15
Board Slot E Terminals of Loops 5, 6 and I/O

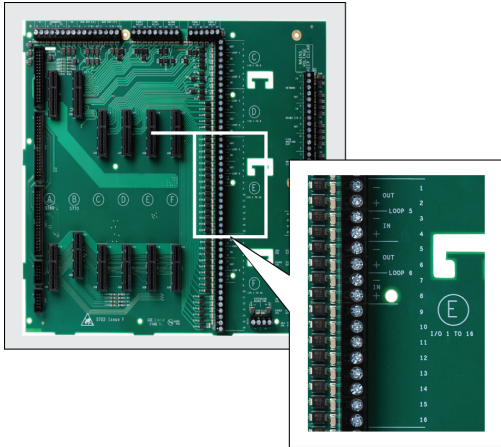

Field Terminals	Board Location	Function
1 - 4, 5 - 8 and 9 - 16	Slot E	Loop 5, 6 or I/O

Board Slot F

The figure below illustrates the Board Slot F Terminals of Loops 7, 8 and I/O:

Board Slot F Terminals of Loops 7, 8 and I/O

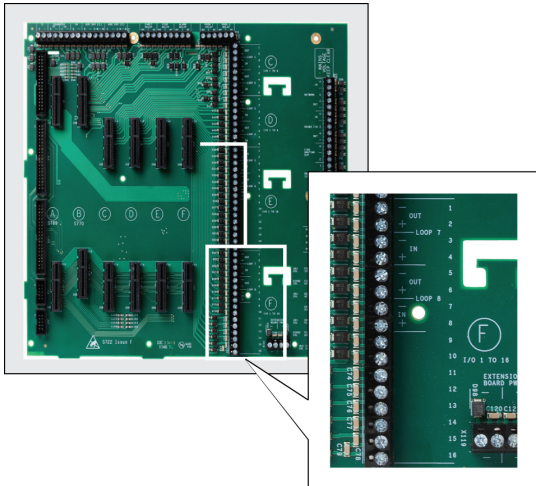

Field Terminals	Board Location	Function
1 - 4, 5 - 8 and 9 - 16	Slot F	Loop 7, 8, I/O or Media Gateway Module

Cable-Tie-Holders

Cable-tie-holders of the Main Back Board provide C-shaped-slots to form and secure cables to the surface of the PCB with cable-ties.

The figure below illustrates cable-tie-holders of the Main Back Board:

Figure 1-16
Cable-Tie-Holders

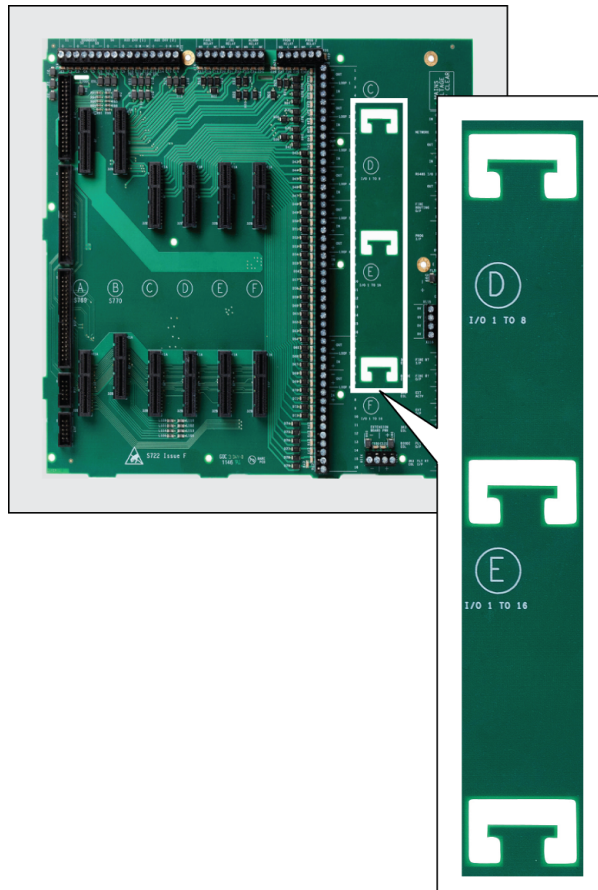

Extension Board Power Terminals

The figure below illustrates Extension Board Power Terminals of the Main Back Board:

Figure 1-17
Extension Board Power Terminals

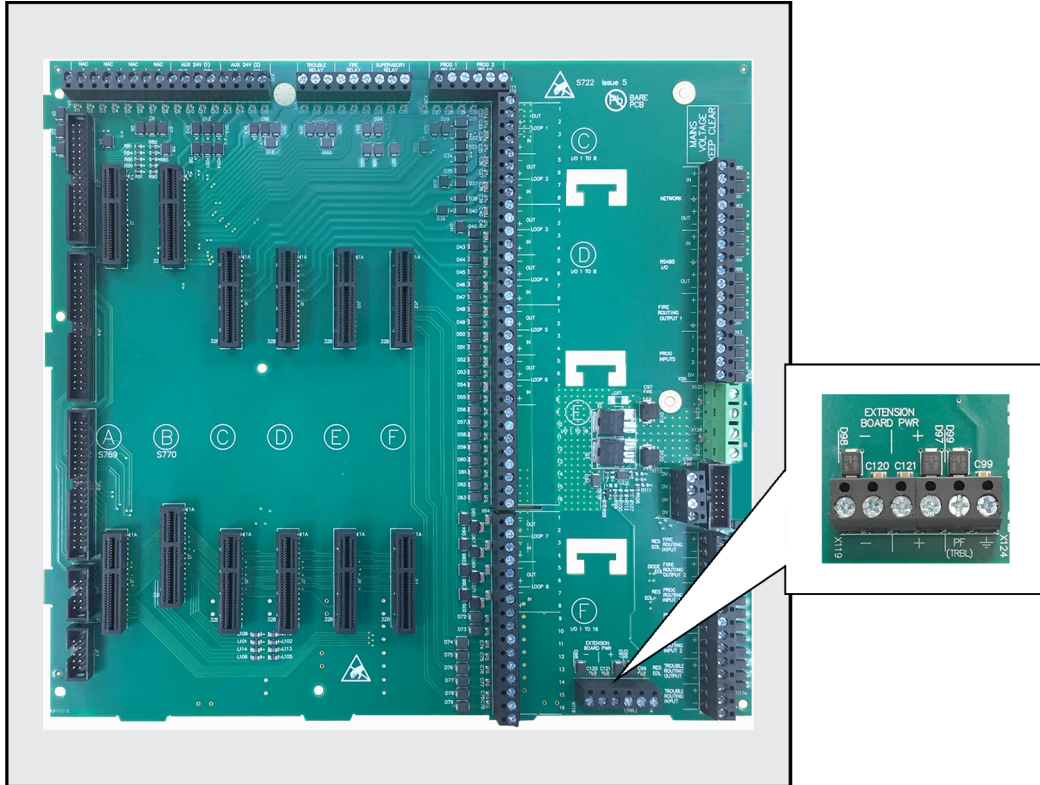

Field Terminals	Description
(-)	Two terminals for providing 0 VDC return-power (-).
(+)	Two terminals for providing 24 VDC power (+).
PF (TRBL)	Power fault terminal.
Ground	Terminal to ground (earth).

These terminals are used for factory wiring purposes only.

Network, RS485 I/O, Fire Routing O/P and Prog I/P

The figure below illustrates Network, RS485 I/O, Fire Routing O/P and Prog I/P of the Main Back Board:

Figure 1-18
Network, RS485 I/O, Fire Routing O/P and Prog I/P

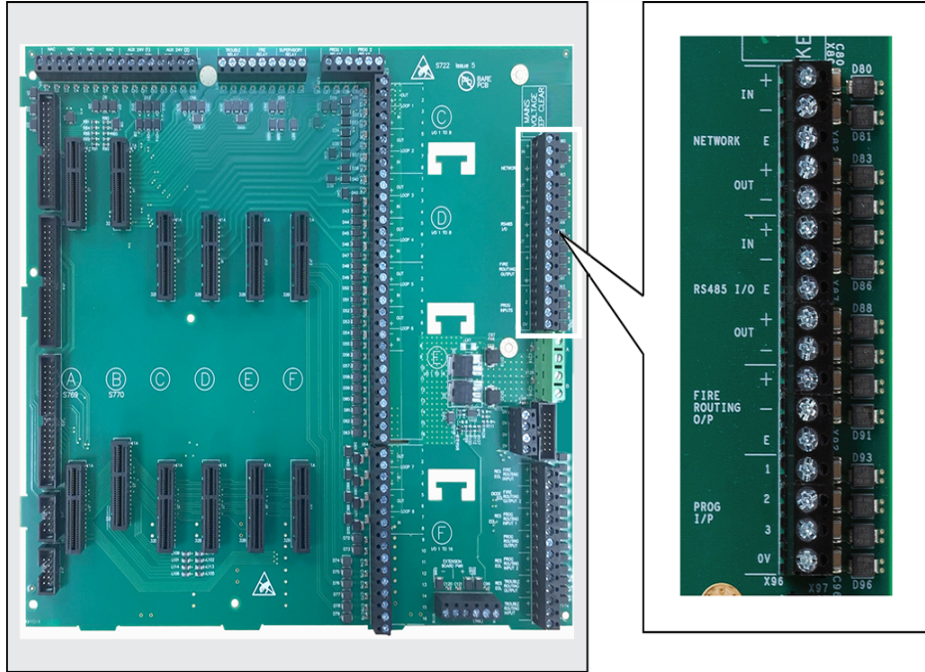

Field Terminals	Description
NETWORK	Provides RS485 networking.
RS485 I/O	Provides ancillary RS485 input and output.
FIRE ROUTING O/P	Provides a dedicated RS485 output for signalling to remote monitoring and control products using a bespoke signalling protocol.
PROG I/P	Provides three programmable inputs that operate on active low thresholds.

Power Supply Terminals

There are two sets of power supply terminals on the main back board.

'PWR A' terminals are used in conjunction with the panel integral power supply and are factory wired.

'PWR B' input terminals for supplementary power supply*.

The figure below illustrates Power Supply Terminals of the Main Back Board:

Figure 1-19
Power Supply Terminals

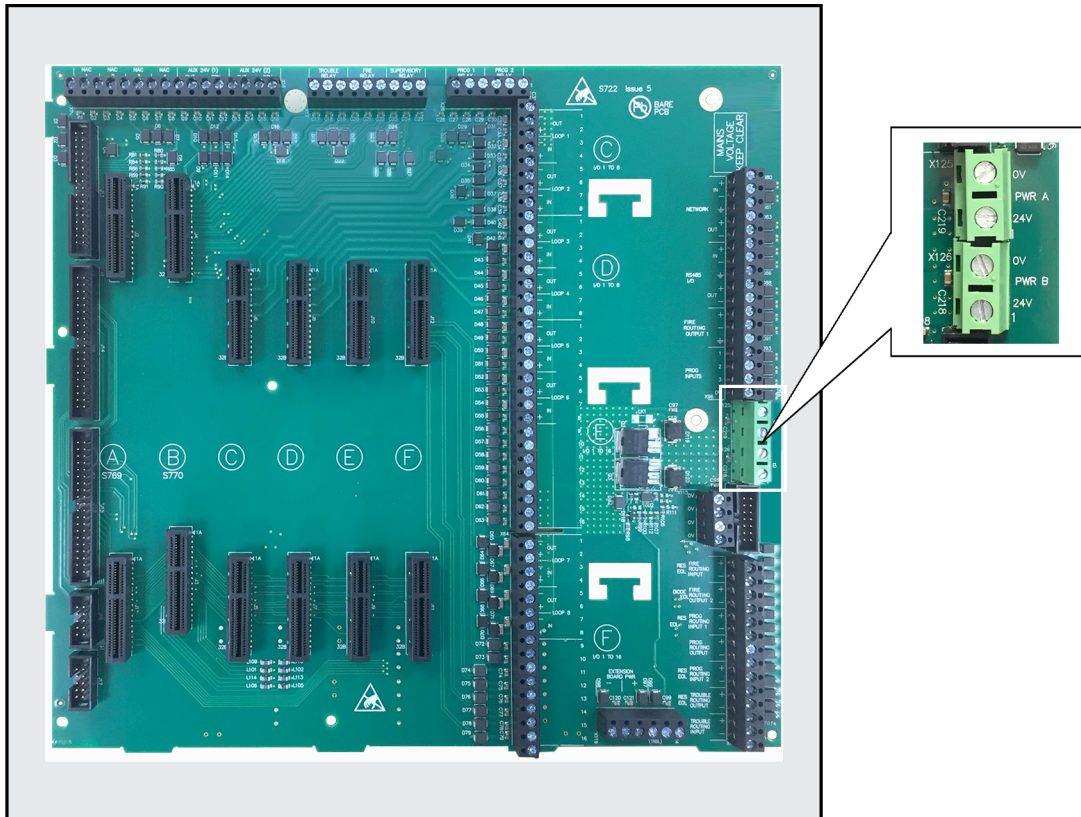

Field Terminals		Description
PWR A	0V	0V terminal for primary power supply (factory wired).
	24V	+24V DC terminal for primary power supply (factory wired).
PWR B	0V	0V terminal for supplementary power supply.
	24V	+24V DC terminal for supplementary power supply.

***Important!** Refer to Installation section of this manual for details regarding the use of any supplementary power supply.

0V Terminals

The figure below illustrates 0V Terminals of the Main Back Board:

Figure 1-20
0V Terminals

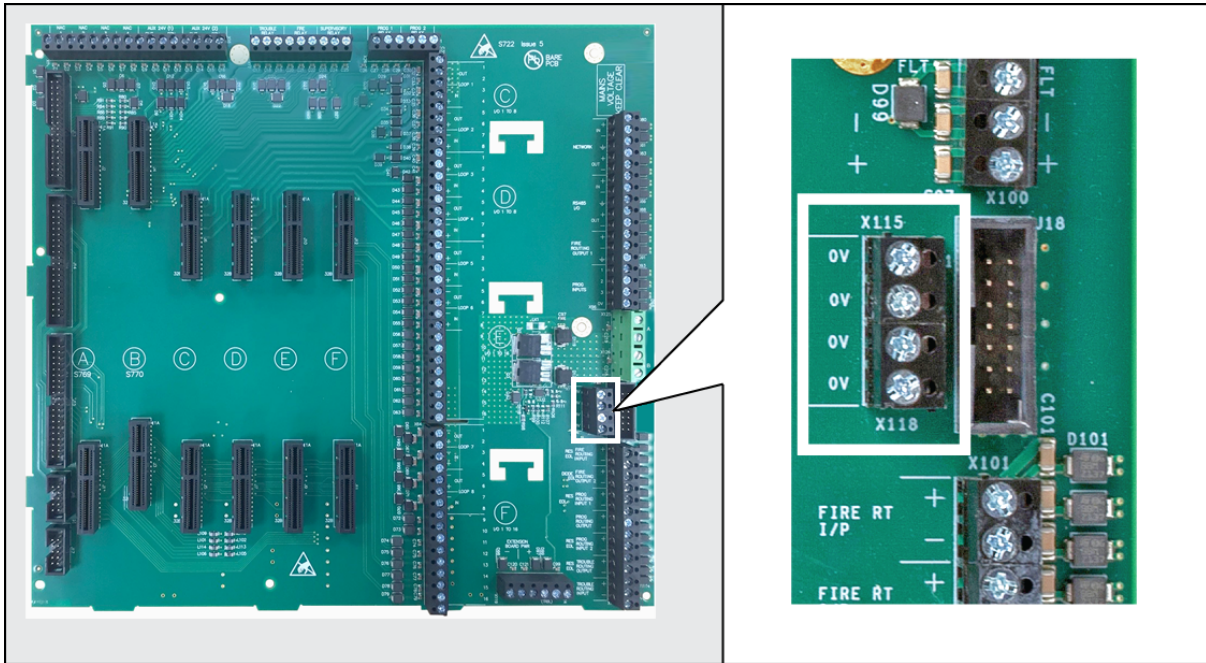

Field Terminals	Description
0V	Provides general purpose 0V.

Power Supply Fault Signalling Connector

The figure below illustrates the Power Supply Fault Signalling Connector of the Main Back Board:

Figure 1-21
Power Supply Fault Signalling Connector

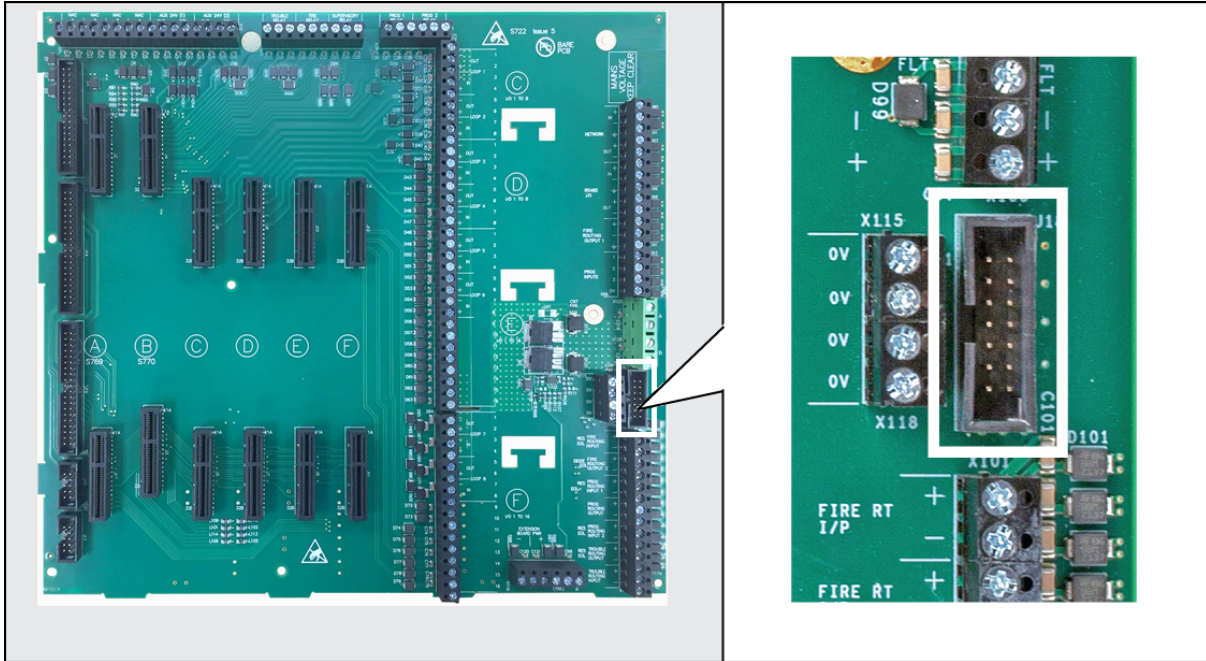

Field Terminals	Description
Power Supply Fault Signalling Connector	Provides power and fault signalling from the 5.25 Amp or 10.25 Amp Power Supply to the FACP.

Monitored Input and Output Terminals

The figure below illustrates Monitored Input and Output Terminals of the Main Back Board:

Figure 1-22
Monitored Input and Output Terminals

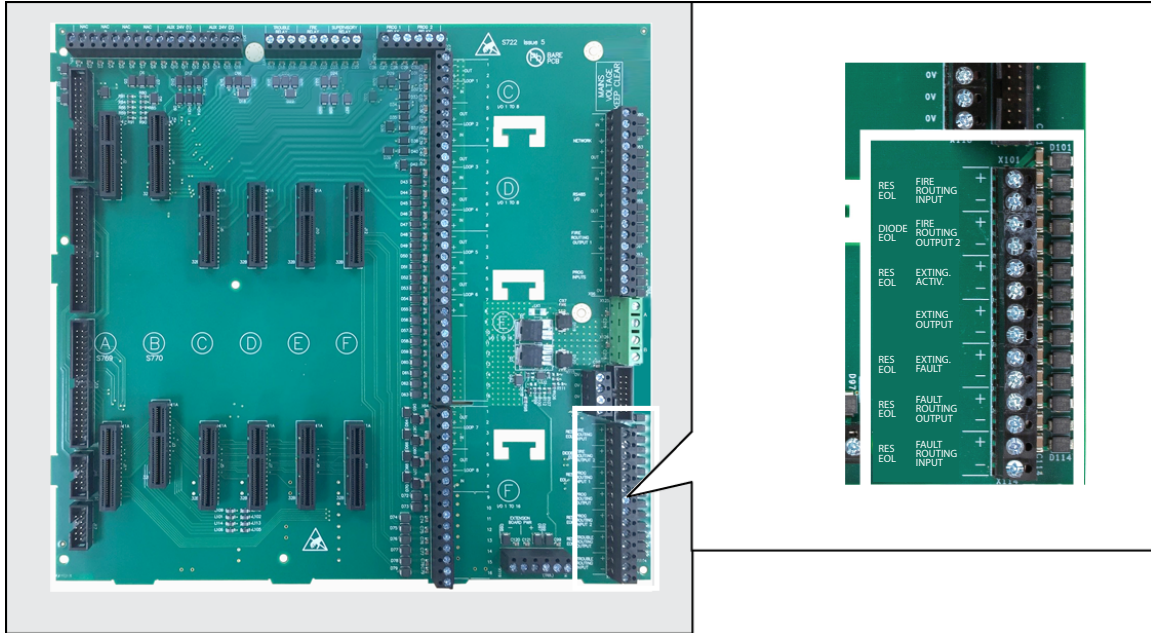

Field Terminals	Description	End of Line	Trigger/Condition
FIRE ROUTING INPUT	Fire Routing Input	3K3 Resistor	470R
FIRE ROUTING OUTPUT 2	Fire Routing Output	Diode	n/a
EXTING. ACTIV.	Extinguishant Activated Input	3K3 Resistor	680R
EXTING. OUTPUT	Extinguishant Output	In circuit 3K3 Quiescent state	680R Present upon activation
EXTING. FAULT	Extinguishant Fault input	3K3 Resistor	680R
FAULT ROUTING OUTPUT	Fault Routing Output	3K3 Resistor	n/a
FAULT ROUTING INPUT	Fault Routing Input	3K3 Resistor	470R

Extension Board

The extension board is fitted to the 2 to 16 Loop version only. Where loop cards are not fitted, the slots can be used to operate Additional Boards.

The figure below illustrates connection properties of the Main Back Board:

Figure 1-23
Extension Board

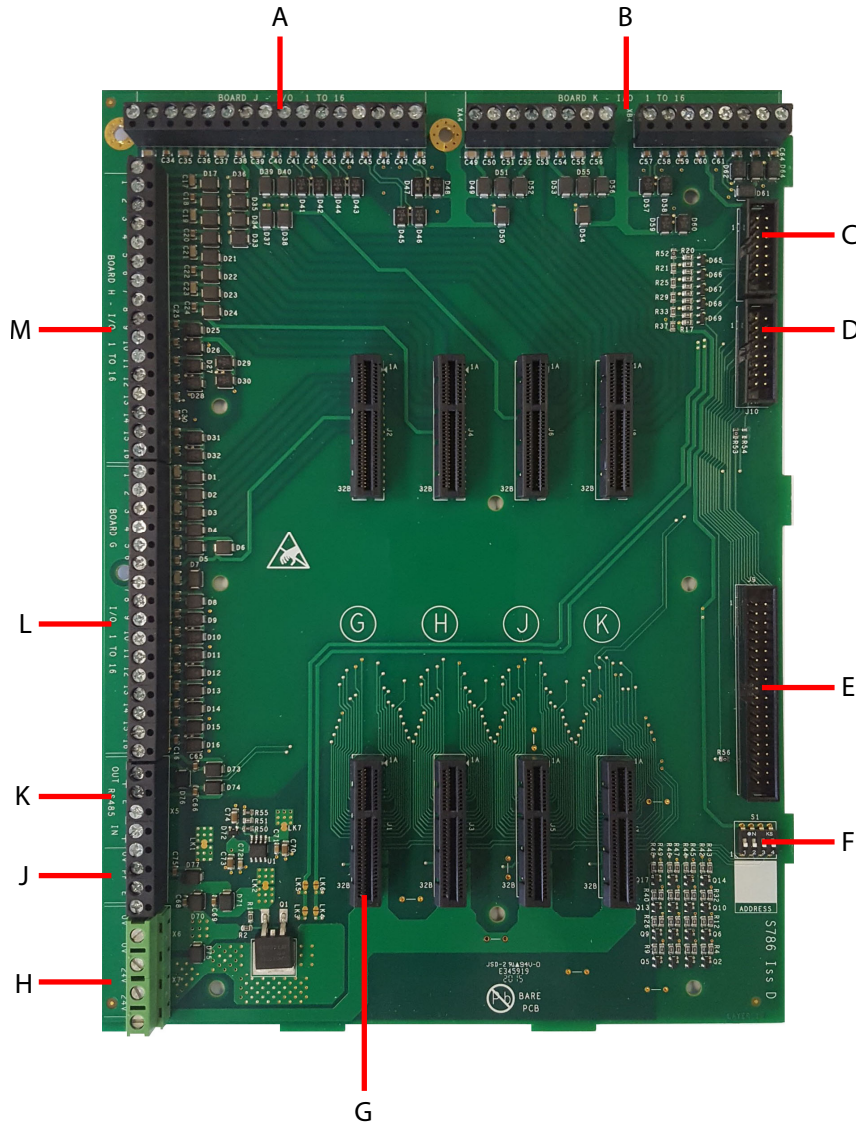

Key	Description	Key	Description
A	J Slot Terminals	G	Board slots
B	K Slot Terminals	H	24V Input terminals
C	Interface for manufacturing purposes only	J	0V, Power Fault and Earth Terminals
D	Interface for manufacturing purposes only	K	RS485 interface terminals
E	Ribbon Connection to Main Back Board	L	G Slot Terminals
F	DIP switches for future use	M	H Slot Terminals

LCD Main Processor Board

The LCD Main Processor Board provides the touch-display, central processing and memory for the FACP. The LCD Main Processor Board mounts to the cabinet-lid of the FACP and includes hardware features such as connectors, ports, switches, LED indicators and the internal buzzer.

Connectors and Ports

The figure below illustrates connectors and ports of the LCD Main Processor Board:

Figure 1-24
Connectors and Ports

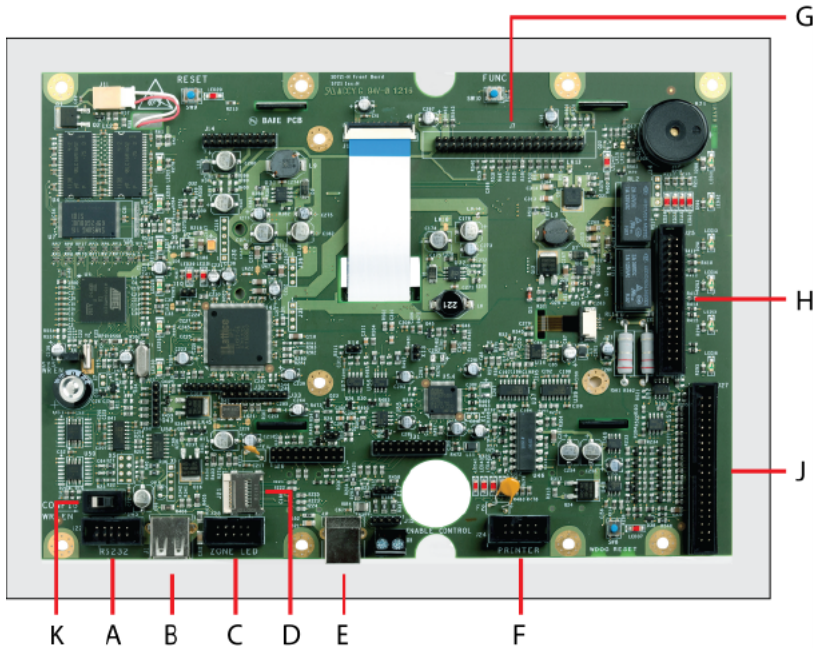

Key	Description	Key	Description
A	Auxiliary RS232 port 1.	F	RS232 thermal printer connection.
B	USB A Used for memory device such as pen-drives or other mass storage devices.	G	Panel network, Ethernet and IFAM interface module connection header.
C	Zone LED board connector.	H	Back Board connector carrying serial interfaces such as networking, I/O interfaces signals, Fire routing signals, RS485.
D	Micro SD card for memory expansion logging or configuration data storage.	J	Back board connector carrying signals for internal cards such as loops, RS485 full duplex, I/O card RS485 communications, sounder patterns, reset, memory write enable, common fire and faults.
E	USB B Used for PC connections and configuration data transfer.	K	Write enable switch.

Switches, LED Indicators and The Internal Buzzer

The figure below illustrates switches, LED indicators and the internal buzzer of the LCD Main Processor Board:

Figure 1-25
Switches, LED Indicators and The Internal Buzzer

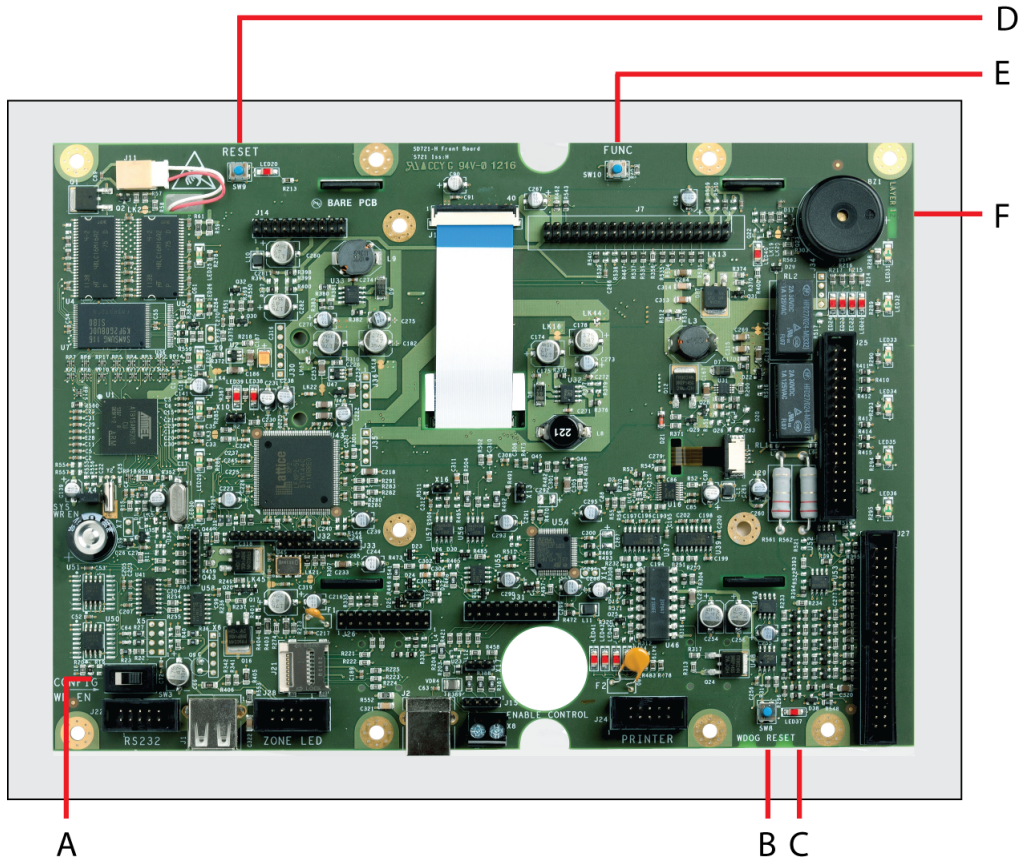

Key	Description	Key	Description
A	Memory write enable switch	D	Reset button
B	Watch Dog Reset button	E	Calibration button for touch-panel-display
C	Watch Dog Trip LED	F	System Buzzer

Required Circuit Boards

Circuit boards of the cabinet can be added, configured and replaced without altering field wiring connections. This modularity allows each FACP to be customized for specific operation.

Circuit boards of the FACP are installed and configured for required and optional features. Required circuit boards provide the FACP with minimum fire alarm control functionality.

Required circuit boards for an addressable EN54 compliant FACP include:

- System Board A Module
- System Board B Module
- Dual Loop Module

Minimum Operation and Basic Function

The FACP must include the System Board A Module, System Board B Module and the Dual Loop Module for minimum operation. Minimum operation describes the FACP as an operating FACP.

All circuit boards are field replaceable.

The figure below illustrates minimum functions of the FACP with the Main Back Board containing System Board A Module, System Board B Module and the Dual Loop Module.

Figure 1-26
Minimum Functionality

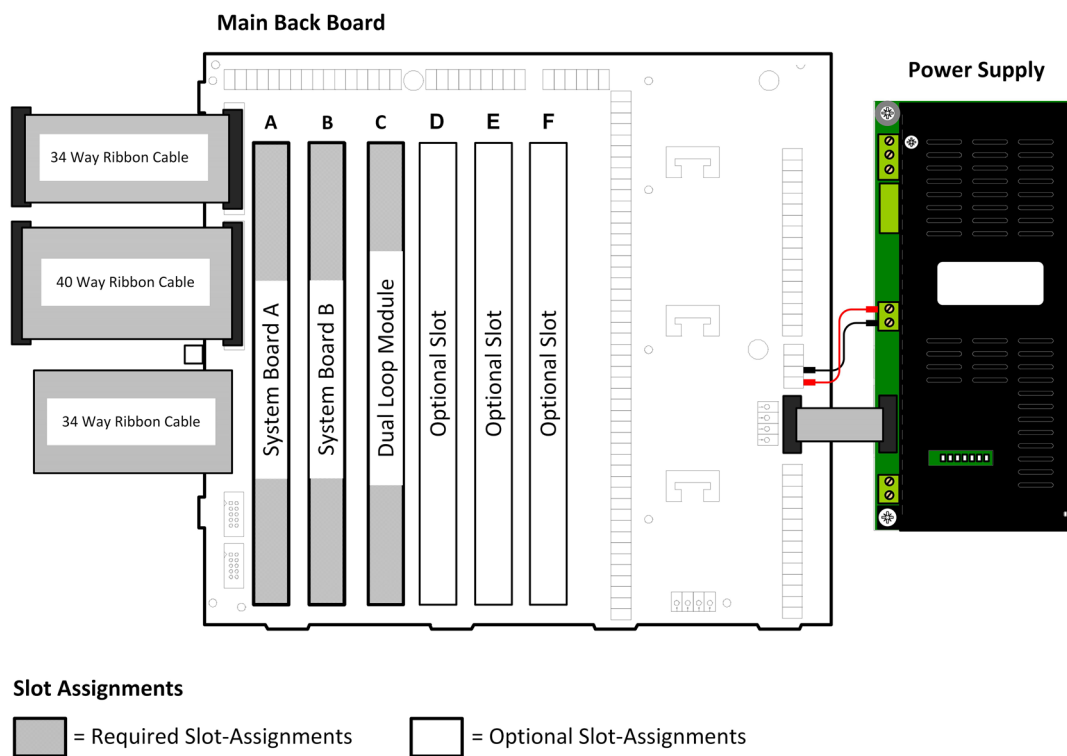

System Board A Module

System Board A Module fits into slot A of the Back Board and contains power supply monitoring, earth fault monitoring and four sounder output circuits. It also provides voltage reversal protection to all circuit boards of the FACP.

The figure below illustrates System Board A Module of the FACP:

Figure 1-27
System Board A Module

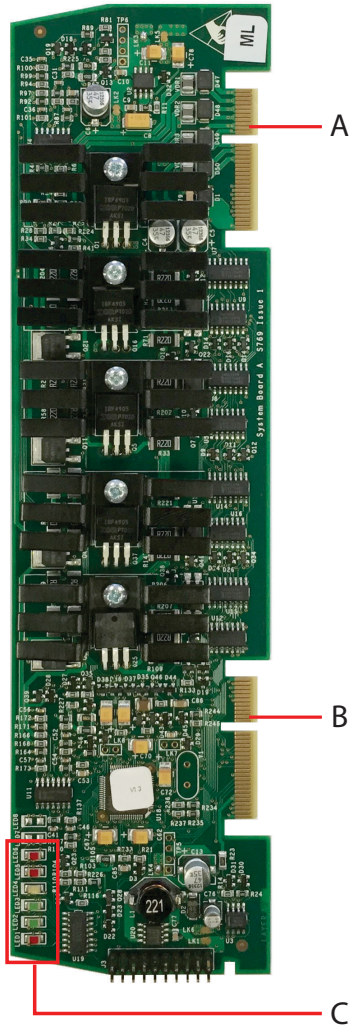

Key	Description
A	Edge connector for termination at slot A of the Main Back Board.
B	Edge connector for termination at slot A of the Main Back Board.
C	LED's 1 through LED 6 provide the following information:
	LED 1 Heartbeat flashes RED to identify functional status of System Board A Module.
	LED 2 Rx Comms flashes GREEN to identify receiving data.
	LED 3 Tx Comms flashes GREEN to identify transmitting data.
	LED 4 Fault flashes YELLOW to identify an error condition.
	LED 5 Input Active LED flashes RED to indicate that the input is receiving data.
	LED 6 Output Active LED flashes RED to indicate that the output is transmitting data. During a firmware update LED flash frequency increases.

System Board B Module

The System Board B Module fits into slot B of the Main Back Board and controls the fire, fault and programmable relays, auxiliary 24 volts, fire routing, fault routing and extinguisher inputs and outputs.

The figure below illustrates System Board B Module of the FACP:

Figure 1-28
System Board B Module

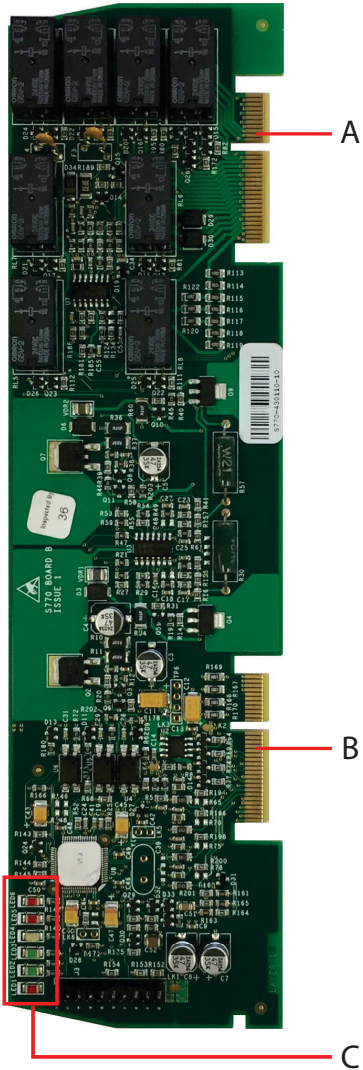

Key	Description
A	Edge connector for termination at slot B of the Main Back Board.
B	Edge connector for termination at slot B of the Main Back Board.
C	LED's 1 through LED 6 provide the following information:
LED 1	Heartbeat flashes RED to identify functional status of System Board B Module.
LED 2	Rx Comms flashes GREEN to identify receiving data.
LED 3	Tx Comms flashes GREEN to identify transmitting data.
LED 4	Fault flashes YELLOW to identify an error condition.
LED 5	Input Active LED flashes RED to indicate that the input is receiving data.
LED 6	Output Active LED flashes RED to indicate that the output is transmitting data.
	During a firmware update LED flash frequency increases.

Dual Loop Module

The Dual Loop Module provides two addressable loops on the FACP. The Dual Loop Module must be fitted in an available slot C through F of the Main Back Board for 2 to 8 loop versions of the panel. On 2 to 16 loop versions of the panel where the Extension Board is featured, Dual loop modules can be fitted to slots G through to K.

*Up to 4 Dual Loop Modules can be fitted to 2 to 8 loop versions of the panel to provide up to 8 addressable loops.
Up to 8 Dual Loop Modules can be fitted to 2 to 16 loop versions of the panel to provide up to 16 addressable loops.*

The Dual Loop Module monitors loop device status and provides status to the LCD Main Processor Board. It holds all device configurations and operates in a stand-alone manner where catastrophic failures occur.

The Dual Loop Module talks to other parts of the FACP to maintain the integrity of alarm and fault functions and EN54-2 requirements.

The figure below illustrates the Dual Loop Module of the FACP:

Figure 1-29
Dual Loop Module

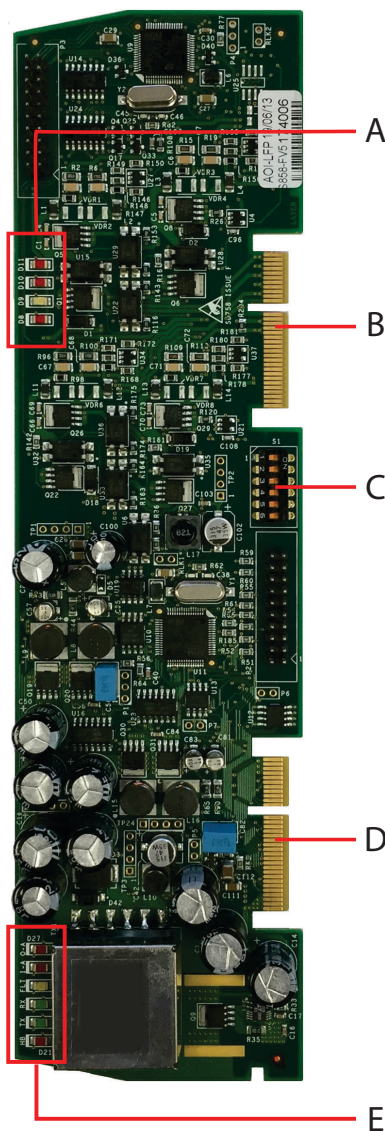

Key	Description	
A	LED's provide the following information:	
	D8	Heart Beat for Processor 2.
	D9	Fault status for Processor 2.
	D10	Loop 1 off state when LED ON.
B	Edge connector for termination at slot C, D, E and F of the Main Back Board and slots G, H, J and K of an Extension Board.	
	Six-position DIP switch S1 for setting the RS485 bus address of the circuit board.	
C	Edge connector for termination at slot C, D, E and F of the Main Back Board and slots G, H, J and K of an Extension Board.	
D	LED's provide the following information:	
	HB	Heartbeat flashes red to identify functional status of the Dual Loop Module.
	TX	Tx Comms flashes green to identify receiving data.
	RX	Rx Comms flashes green to identify transmitting data.
	FLT	Fault flashes yellow to identify an error condition.
	I - A	Input Active LED flashes green to indicate that the input is active receiving data.
O - A	Output Active LED flashes red to indicate that the output is active transmitting data.	

Optional Circuit Boards and Assemblies

Optional circuit boards and assemblies include:

- Network Module
- Zone LED board
- Printer
- Vision unit

Network Module

The Network Module provides enhanced high speed communication for networking up to a maximum of 127 Control Panels. The network provided by this module can support combinations of Control Panels and Vision units.

Control Panels can be configured for master/slave, multiple master/slave or peer to peer connections and receive events from other the Control Panels in the network. The Loop networking used in conjunction with the Network Module provides tolerance against open and short circuit fault conditions.

The Network Module is available in two versions, standard and fully isolated.

The figure below illustrates the Network Module of the FACP:

Figure 1-30
Network Module

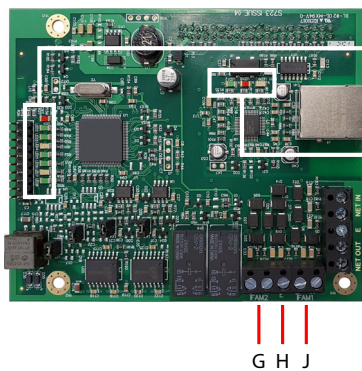

NOTE
Do NOT wire to terminals D, F & F - use terminals on Back Board.

Key	Description	
A	LED 1 through LED 8 provide the following status information	
	LED 1	Red Heartbeat
	LED 2	Green, Comms Tx for network
	LED 3	Green, Comms Rx for network
	LED 4	Yellow, Internal fault for network
	LED 5	Green, Comms Tx for IFAM
	LED 6	Green, Comms Rx for IFAM
	LED 7	Yellow, Internal fault for IFAM
LED 8	Green, Comms for SPI Bus	
B	NOT USED: RJ45 connector	
C	LED 9, LED 10 and LED 12 provide the following status information:	
	LED 9	Yellow, Full duplex (on) half duplex (off)
	LED 10	Red, Speed, 10MHz (off), 100MHz (on)
LED 12	Green, Communication present when flashing	
D	NOT USED: NET OUT *See Note	
E	NOT USED: E, earth ground. *See Note	
F	NOT USED: NET IN *See Note	
G	NOT USED: IFAM2	
H	NOT USED: E, earth ground.	
J	NOT USED. IFAM1	

Zone LED Board

The Zone LED Board contains 48 LEDs and is fitted to the LCD Main Processor Board of the FACP. A maximum of three Zone LED Boards can be fitted within the 2-8 loop enclosure to provide the fascia of the FACP with 144 Zone LED indicators.

The figure below illustrates the component side of the Zone LED Board:

Figure 1-31
Zone LED Board

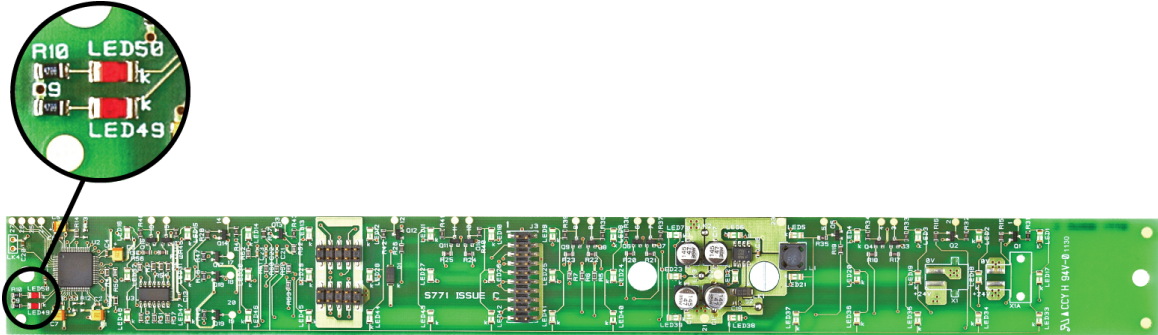

Zone indicators are not shown on the component-side image above. Zone indicators are located on the opposite side of the circuit board.

The component-side of the Zone LED Board is visible when the lid of the FACP is open. Zone LED indicators are not present on the component-side of the Zone LED Board. The opposite side of the image shown contains Zone LED indicators. LED 50 flashes red when the heartbeat is operating on the Zone LED Board. LED 49 is red when data is received on the Zone LED Board.

The figure below illustrates the location of the Zone LED Board on the lid of the FACP:

Figure 1-32
Zone LED Board Location

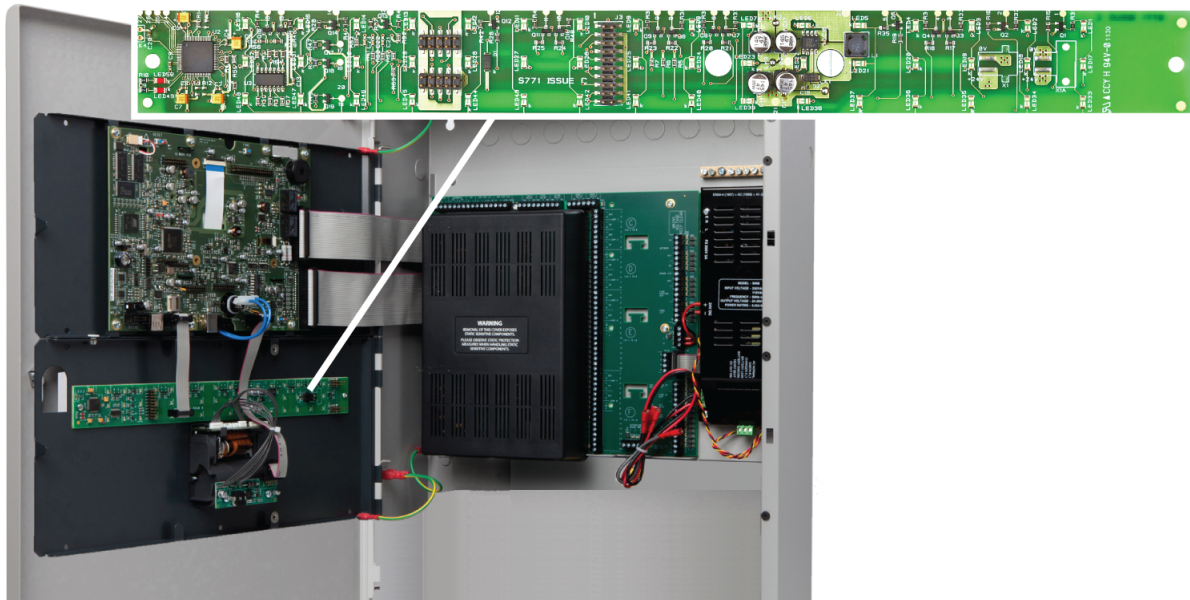

Vision Unit.

The Vision Unit provides a full-colour graphical-display and touch-screen. The Vision Unit is a full function fire alarm repeater that is configurable and application flexible.

The Vision Unit can be configured to replicate functions of a FACP or to operate as a display-only-device for applications where FACP functions are unavailable.

The figure below illustrates the fascia of the Vision Unit:

Figure 1-33
Fascia of the Vision Unit



The Vision Unit can be flush-mounted or recessed on a wall using our quick-fix adaptor-frame. Special finishes and colours are available for models of the Vision Unit.

The figure below illustrates Vision Unit internal features:

Figure 1-34
Vision Unit internal features

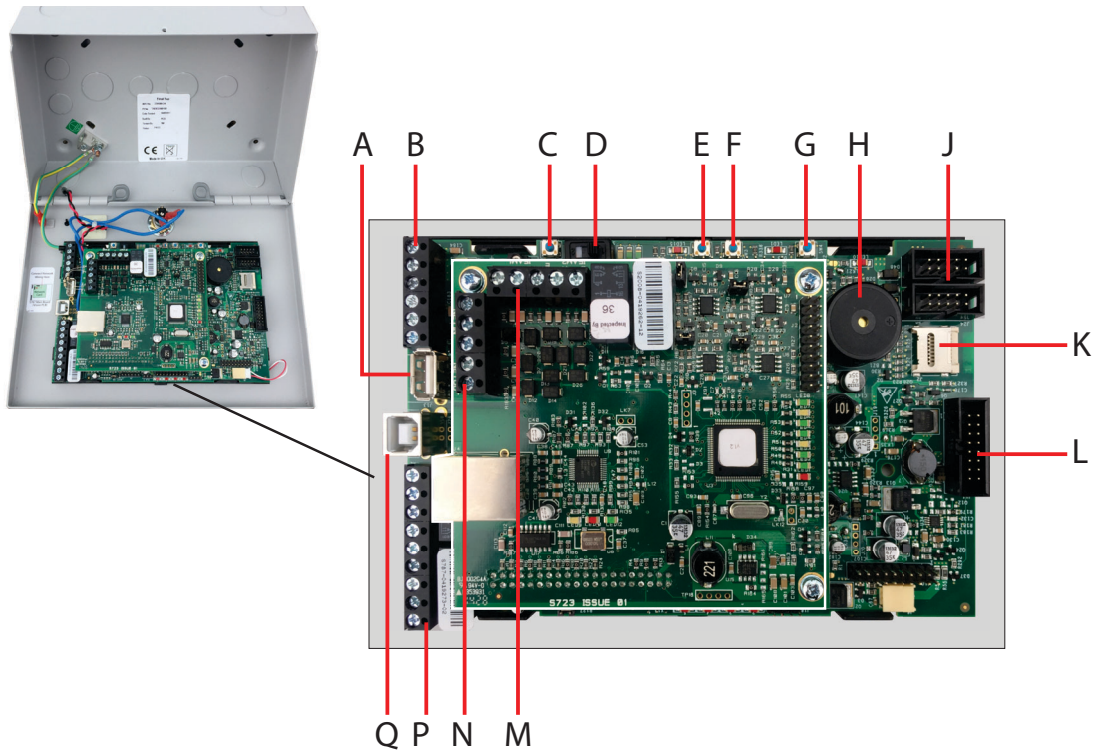

Key	Description	Key	Description
A	USB to PC communications port	H	Buzzer
B	24 V In/Out, Remote PSU monitor & Ground Terminals	J	Proprietary connections for manufacturing purposes
C	Reboot button (panel firmware dependent)	K	SD card slot
D	Write Enable switch	L	No function
E	No function	M	IFAM terminals
F	No function	N	Network terminals (Net in, Net out)
G	Processor reset button	P	Not used
Q	USB to PC communications port		

Power Supplies

Models of the FACP can include the 5.25 Amp or the 10.25 Amp power supply. The 5.25 Amp Power Supply can charge standby-batteries up to 26Ah. The 10.25 Amp power supply can charge standby-batteries up to 45Ah.

Both power supplies provide an output voltage of 24V and accept input voltages of 115 VAC or 230 VAC.

A jumper connection on the 5.25 Amp Power Supply is used to set input voltages for 115 VAC or 230 VAC. The jumper connection is set at the factory according to input voltage requirements of the customer.

The 10.25 Amp power supply does not provide a jumper connection to select between input voltages. This power supply includes a universal input feature that automatically compensates for input voltages between 95V and 250V AC.

Features

Features of the power supplies include:

Deep-Discharge Prevention	The 10.25 Amp Power Supply prevents deep-discharge of the standby-batteries by disconnecting the load when the standby-battery-voltage drops below 19+/-1V DC. A deep-discharge can cause permanent damage to standby-batteries. Preventing this condition allows standby-batteries to recharge for continued operation after extended power-outages.
Battery-Backup	Provides battery power to the load when the AC input of the power supply falls below the rated level. The voltage at the load remains within the specified range during these switching-transitions.
Battery-Boost	Boosts standby-battery voltage to maintain a constant 22 VDC when the voltage drops below the 22 VDC level.
Short-Circuit Protection	Provides a shut down on the load side of the power supply when the load-current exceeds the maximum level.
Automatic-Retry	Restores output to the load when operating conditions return to nominal levels. This feature restores voltage levels at the load following conditions such as over-current and battery depletion.
Battery Impedance	Provides a fault warning when the impedance of the battery charging circuit reaches a level that affects operation of the system.
Battery Supervision	Battery presence and low battery voltage supervision
Earth Fault detection	Earth Fault Detection
General Fault Relay	All faults are reported over the common fault contacts

The figure below illustrates the 5.25 Amp Power Supply of the FACP:

Figure 1-35
5.25 Amp Power Supply



The figure below illustrates the 10.25 Amp Power Supply of the FACP:

Figure 1-36
10.25 Amp Power Supply



Status Indicators

Status indicators are located on the 5.25 Amp and 10.25 Amp power supplies for diagnostic information.

The figure below illustrates status indicators of the 10.25 Amp Power Supply:

Figure 1-37
Power Supply Status Indicators

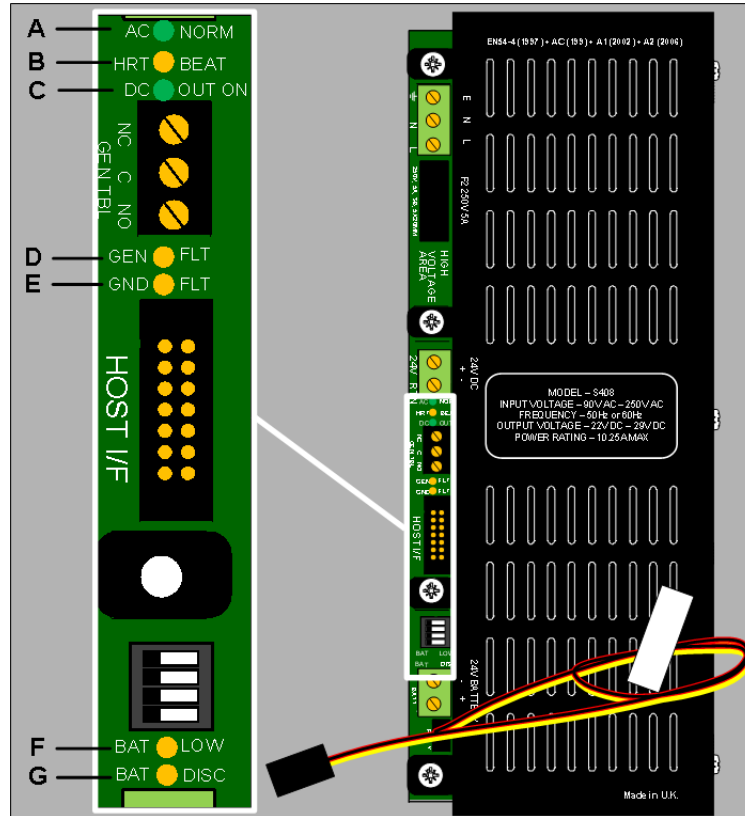

Status indicators of the 10.25 Amp Power Supply are identical to those of the 5.25 Amp Power Supply.

Key	LED Indicator	Illuminated Colour	Condition When Illuminated
A	AC Normal	GREEN	Mains power is connected.
B	Heartbeat	YELLOW	The processor is functioning when the heartbeat is flashing.
C	DC Out on	GREEN	The 24V DC output is supplying power to the load.
D	General fault	YELLOW	The battery charge voltage is too high.
E	Earth fault	YELLOW	The 24V DC supply or other data signal I/O is connected to earth.
F	Battery low	YELLOW	The battery voltage is drops below 20.4V DC.
G	Battery disconnected	YELLOW	Standby-batteries are disconnected.

Functional Features

The following summarises the standard features found on all models of the FACP's:

Inputs and Outputs

Input and Output features of the FACP's include:

Feature	Description
Detection Loops	One to eight circuits, two per loop card
Sounder Outputs	Four sounder outputs. Each pair of sounder outputs can be converted to one loop circuit.
Auxiliary 24V Supplies	Two outputs, programmable
Fault Relay	Volt free changeover contact, programmable
Fire Relay	Volt free changeover contact, programmable
Alarm Relay	Volt free changeover contact, programmable
Programmable Relay 1	Volt free changeover contact
Programmable Relay 2	Volt free changeover contact
Programmable Inputs	Three independently programmable inputs
Fire Routing Input	Supervised input to receive confirmation signal from fire routing equipment. Re-programmable for any input event type.
Fire Routing Output	Voltage reversing output, 24V DC for signalling fire routing equipment. Re-programmable for any output event type.
Fault Routing Output	Voltage reversing output, 24V DC for signalling fault routing equipment. Re-programmable for any output event type.
Fault Routing Input	Supervised input to receive confirmation signal from fault routing equipment. Re-programmable for any input event type.

Communication

Communication features of the FACP include:

Feature	Description
USB Type A	One USB type A port
USB Type B	One USB type B port
Ancillary RS485 Bus	Connection provides up to 32 ancillary devices with 512 programmable points
Fire Routing RS485 Bus	Configurable and compatible with proprietary fire brigade interface equipment
RS232 Port 1	Configurable RS232 port 1 for ancillary devices
RS232 Port 2	Configurable RS232 port 2 for ancillary devices

Expansion

Expansion features of the FACP include:

Feature	Description
Auxiliary Connector	Connector for providing additional detection loops and I/O modules
Network Card Connector	Supports networking of panels through an RS485 connection
I/O Board Connectors	Connectors for I/O boards to be fitted in lieu of two loop boards.
Micro SD card Connector	Micro SD card connector for flash memory expansion
Printer Connector	Connector for panel mounted Printer (RS232)
Zone LED Board Connector	Connector for Zone LED boards.

User Interface

User interface features of the FACP include:

Feature	Description
Display	Full colour, 7" (178 mm) VGA LCD with resistive touch panel. Context sensitive controls on touch screen display. No additional controls. Configurable screen with customer logo and/or contact details. Ambient light sensor for automatic brightness level adjustment.
Keyswitch	Keyswitch for user level access to FACP controls.
Indicators	LED indicators provide illumination for mandatory FACP indications.

Power

Power features of the FACP include:

Feature	Description
Input power	230V AC or 115V AC
Power supplies	5.25 A 24V DC or 10.25 A 24V DC
Battery Capacity	26Ah* (standard enclosure). 45Ah* (deep enclosure). *Power-sonic batteries.

Configuration

Configuration features of the FACP include:

Feature	Description
Fascia Controls	Configure the FACP through the level 3 front panel fascia controls.
Programming	Configure the FACP using the Loop Explorer configuration utility programme.
Computer	Provide programming using a computer connection to the USB type B connector of the FACP.
Flash Memory Stick	Provide programming using a flash memory stick connection to the USB type A connector of the FACP.

Section 2

Installation

This section provides instructions for connecting cables, mounting and testing the FACP (Fire Alarm Control Panel) for installation.

General Installation Checklist

To complete the installation:

- 1 Create a plan of the fire alarm system and checklist for installing the FACP.
- 2 Remove the FACP from its packaging and check its contents.
- 3 Open and remove the fascia-door from the FACP cabinet.
- 4 Open and remove the lid from the cabinet of the FACP.
- 5 Disconnect and remove ribbon cables and earth cables.
- 6 Remove the back-plate from the cabinet.

CAUTION!



Maintain extreme care when anchoring the cabinet to the premises wall. Electronic components within the FACP are vulnerable to physical damage from severe shock and vibration. Remove the cabinet-door and fascia from the cabinet when installations cannot guarantee vigilant care during cabinet anchoring.

- 7 Mount the empty-cabinet of the FACP to the premises wall.
- 8 Thread cabling into the cabinet and secure it to the terminals of the FACP.
- 9 Re-attach the back-plate to the cabinet.
- 10 Place standby-batteries in the base of the cabinet.
- 11 Re-attach the fascia-door of the FACP.
- 12 Re-attach the lid to the FACP cabinet.
- 13 Dress and reconnect ribbon cables and earth cables.
- 14 Determine the current consumption of the fire alarm system.
- 15 Determine the battery capacity of the FACP.
- 16 Connect the standby-batteries to the BATTERY terminals of the power supply.
- 17 Close the fascia-door and the lid of the FACP.
- 18 Apply power to the FACP from the AC source.
- 19 Test the installation of the FACP.

Before You Begin

Before you begin the installation, take a few minutes to review the installation information, gather the required items, and complete the tasks listed below to make the installation as quick and easy as possible.

CAUTION!



The FACP installation must be performed by qualified personnel familiar with electronic components. Electronic components within the FACP are vulnerable to damage from electrostatic discharge. Ground straps must be worn by installers before handling FACP circuit boards to prevent damage from electrostatic discharge.

- 1 Create a plan and checklist before beginning the installation process. Planning can reduce the number of problems that can occur during installation.
- 2 Select an environment that is suitable for operating the FACP. The site chosen for mounting the FACP should be clean and dry and not subject to excessive shock or vibration. Ensure that the FACP environment is free from wire ends, knockout discs and other debris.
- 3 Verify that you received the following items to operate base functions of the FACP:

Item	Quantity	Description
5.25 Amp or 10.25 Amp Power Supply	1	The 5.25 Amp or 10.25 Amp power supply are the power-sources of the FACP. <i>All models of the FACP contain the 5.25 Amp or 10.25 Amp Power Supply.</i>
Main Back Board	1	The Main Back Board of the FACP contains slots for six circuit boards. The Main Back Board accepts the System Board A Module, System Board B Module, Dual Loop Modules. <i>All models of the FACP contain the Main Back Board.</i>
Extension Board	1	The Extension Board is fitted to the right hand side of the Main Back Board. <i>Only fitted to 16 Loop versions of the FACP.</i>
LCD Main Processor Board	1	The LCD Main Processor Board provides operation of the touch-panel-display. <i>All models of the FACP contain the LCD Main Processor Board.</i>
Network module (Optional)	1	Provides networking functionality to the panel, each panel that is networked will require a network module.
Network, Ethernet & IFAM module (Optional)	1	Provides networking, Ethernet and IFAM functionality to the panel, each panel that is networked will require a network module.
System Printer (Optional)	1	The printer allows the printing of lie or logged fire-system events. It is mounted on the front fascia of the panel.
10 Conductor IDC Printer Cable (Optional-Only required when Printer Installed)	1	The 10 Conductor IDC Printer Cable connects from the connector on the printer assembly to the "Printer" connector on the LCD Main Processor Board.

Item	Quantity	Description
System Board A Module	1	A System Board A Module is required for operation of the FACP. <i>All models of the FACP contain one System Board A Module.</i>
System Board B Module	1	A System Board B Module is required for operation of the FACP. <i>All models of the FACP contain one System Board B Module.</i>
Dual Loop Module	1	The Dual Loop Module provides two addressable loop functions for the FACP. <i>All models of the FACP contain one Dual Loop Module.</i>
Earthing Cable	4	The earthing cable is yellow-stripped-green, 1.0 mm, insulated wire containing connecting lugs. Earthing cabling provides common electrical earth connections to the cabinet-lid, fascia and back-plate.
14 Way IDC PSU Signal Cable	1	The 14 Way IDC PSU Signal Cable connects from the J5 connector of the 5.25 A or 10.25 A Power Supply to the J18 connector of the Main Back Board.
Battery Jumper Lead	1	The Battery Jumper Lead connects from the (+) terminal of standby-battery 1 to the (-) terminal of standby-battery 2.
Battery Black Lead	1	The Battery Black Lead connects from the power supply, BATTERY (-) terminal to the (-) terminal of standby-battery 1.
Battery Red Lead	1	The Battery (+) Red Lead connects from the power supply, BATTERY (+) terminal to the (+) terminal of standby-battery 2.
PSU Power 0V Lead	1	The PSU Power 0V Lead connects from the RTN terminal of the power supply to the (-) terminal of connector X96 on the Main Back Board. ***
PSU Power 24V Lead	1	The PSU Power 24V Lead connects from the 24V terminal of the power supply to the (+) terminal of connector X96 on the Main Back Board. ***
34 Way IDC Cable	1	The 34 Way Cable connects from the J13 connector of the Main Back Board to the J25 connector of the LCD Main Processor Board.
40 Way IDC Cable	1	The 40 Way Cable connects from the Main Back Board to the J24 connector of the LCD Main Processor Board.
Zone LED Boards(s) (Optional)	1-3(max)	The Zone LED Boards (s) are required if an individual optical indication of each zones is required. Note: this information is displayed on the LCD screen as standard

Item	Quantity	Description
10 Way IDC Zone LED Cable (Optional-Only required when a zone card is Installed)	1	The 10 Way IDC Zone LED Cable connects from the J1 connector of the LED Zone Board to the J28 connector of the LCD Main Processor Board.
10 Conductor IDC Zone LED to LED Cable (Optional-Only required when more than one zone card is Installed)	1 or 2	The 10 Conductor IDC Zone LED to LED Cable is a daisy-chain-jumper that connects from the J2 connector of one LED Zone Board to the J1 connector of the next LED Zone Board. One 10 Conductor IDC Zone LED is required when two LED Zone Boards are installed on the fascia of the FACP. Two 10 Conductor IDC Zone LED Cables are required when three LED Zone Boards are installed on the fascia of the FACP.
10 Conductor IDC Printer Cable (Optional-Only required when Printer Installed)	1	The 10 Conductor IDC Printer Cable connects from the connector on the printer assembly to the "Printer" connector on the LCD Main Processor Board.
Fuse Accessory Pack	1	Fuse Accessory Pack containing KD25800 series RPSM2 fuses. FF very fast acting 12A.

- 4 Acquire the following items that are not included with the FACP, but may be required for the installation:

Item	Quantity	Description
Standby-Batteries	2	Two 12 VDC standby-batteries. <i>Refer to Installation Manual Appendices to determine the Amp-Hour capacity required to support the system and recommended model for operating under minimum Amp-Hour conditions.</i>
Mounting Hardware	1	The mounting hardware that secures the FACP to the premises-wall is not provided in the FACP packaging. Mounting screws must be M5 with a minimum length of 30mm
Anti-static handling strap	1	An Anti-static handling strap is required for handling the FACP circuit boards.

*** Locating Connector X96: Connector X96 is in a vertical position below vertical connector X80 on the Main Back Board. Connector X96 includes connections for E, FLT, (-) and (+) of the power supply. Connector X80 includes terminal connections for Network, RS485/O Fire Routing O/P and Prog I/P.

Installing the Fire Alarm Control Panel

Before the system is installed the internal components MUST be removed before the cabinet is fixed in the required location.

Removing Cabinet Components

Remove the Fascia, Lid, Back-Plate and Batteries of the FACP before mounting the Cabinet-Box. The Fascia contains the LCD Main Processor Board and Zone LED indicators of the FACP. The Back-Plate contains the Main Back Board, the 5.25 Amp or 10.25 Amp Power Supply and grounding terminals.

For 16 Loop versions of the FACP negate stages 3, 4 & 7. Fascia panel is adjoined to cabinet door.

To remove these components of the FACP:

- 1 Insert the key and turn clockwise to unlock cabinet-door of the FACP.

Figure 2-1
Unlocking the Cabinet-Door



- 2 Open the cabinet-door.
- 3 Grasp the metal assembly at both ends shown by the arrows and then tug gently to open the fascia of the FACP.

Figure 2-2
Opening the Fascia

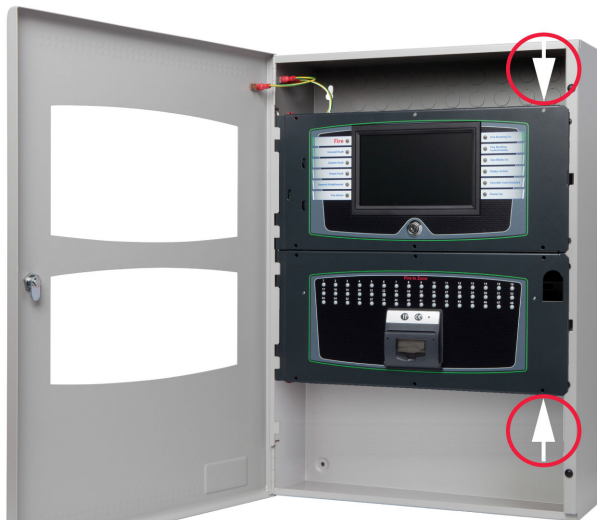

- 4 Open the fascia of the FACP.
- 5 Disconnect four ground jumper cables from the lid and leave the opposite cable ends connected for safekeeping.

Figure 2-3
Removing Ground Connections



- 6 Remove the two ribbon cables from the LCD Main Processor Board.
The cables will be reconnected to the LCD Main Processor Board following Cabinet -Box fixing.

Figure 2-4
Removing Ribbon Cables



- 7 Remove four hinge-pins of the Fascia and then remove the Fascia from the Cabinet-Box of the FACP. Return the four hinge-pins to the hinges of the Cabinet-Box for safekeeping.

Figure 2-5
Removing Hinge-Pins of the Fascia

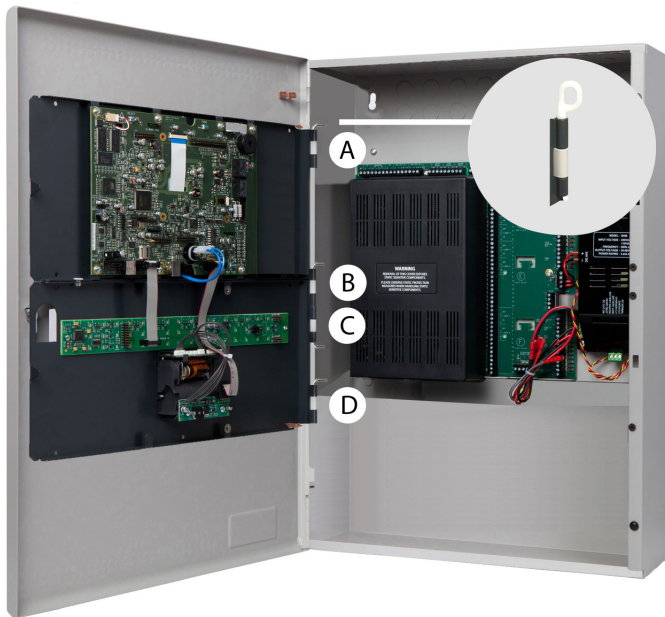

To remove the Fascia from the Cabinet-Box:

- 1 Pull the head of the upper-hinge-pin (A) away from the hinge-assembly using finger in hinge hoop.
- 2 Brace the top-corner of the Cabinet-Lid to maintain alignment with the lower-hinge.
- 3 Pull the head of the lower-hinge-pins (B), (C) and (D) away from the hinge-assembly using finger in hinge hoop.
- 4 Remove the Fascia from the Cabinet-box of the FACP when the four hinge-pins have been removed.

- 8 Remove two hinge-pins of the Cabinet-Lid and then remove the Cabinet-Lid from the Cabinet-Box of the FACP. Return the two hinge-pins to the hinges of the Cabinet-Box for safekeeping.

Figure 2-6
Removing the Hinge-Pins of the Cabinet-Lid

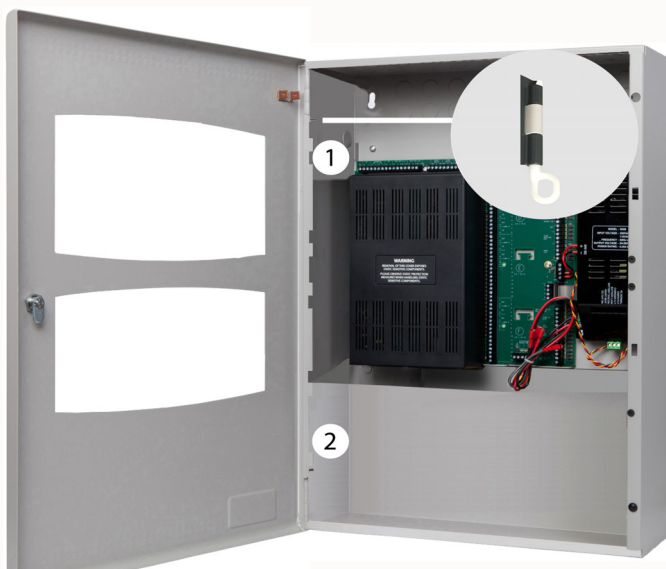

To remove the Cabinet-Lid from the Cabinet-Box:

- 1 Pull the head of the upper-hinge-pin (1) away from the hinge-assembly using finger in hinge hoop.
- 2 Brace the top-corner of the cabinet-door to maintain alignment with the lower-hinge.
- 3 Pull the head of the lower-hinge-pin (2) away from the hinge-assembly using finger in hinge hoop.
- 4 Remove the Cabinet-Lid from the Cabinet-box of the fire Control Panel when the two hinge-pins have been removed.

- 9 Remove two retaining screws from the back-plate and then remove the back-plate from the FACP cabinet. Fit the two retaining-screws in the empty-holes of the box for safekeeping.

Figure 2-7
Removing the Chassis

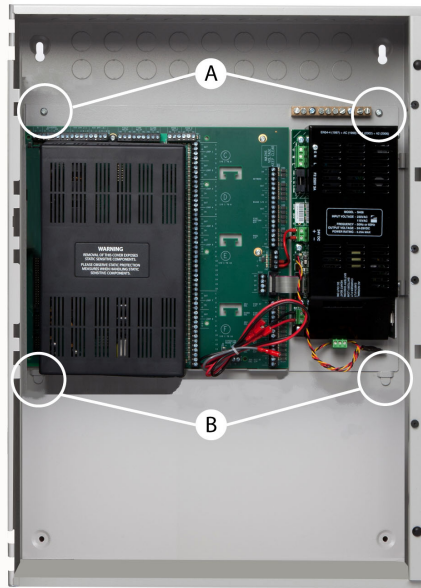

To remove the Chassis from the Cabinet-Box:

- 1** Remove two Posi-head mounting-screws (A) from the top portion of the Chassis.
- 2** Slide the Chassis upward to remove it from tabs (B) of the Cabinet-Box.
- 3** Place the two Posi-head mounting-screws in the holes of the Cabinet-Box for re-attaching the Chassis.

Figure 2-8
Removing the Chassis

For 2 to 16 Loop versions on the FACP Only.

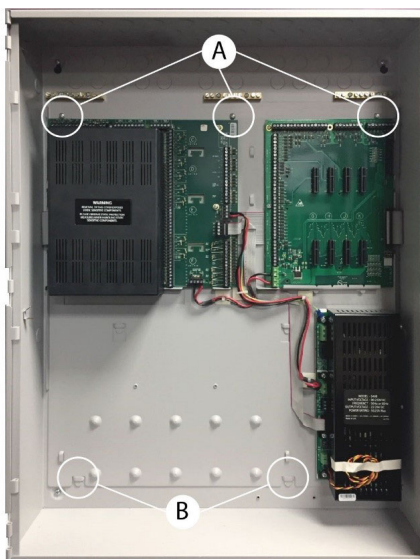

To remove the chassis from the Cabinet-Box:

- 1** Remove three Posi-head mounting-screws (A) from the top portion of the Chassis.
- 2** Slide the Chassis upward to remove it from tabs (B) of the Cabinet-Box.
- 3** Place the three Posi-head mounting-screws in the holes of the Cabinet-Box for re-attaching the Chassis.

Figure 2-9
Empty Cabinet-Box of the FACP



Setting the Location

The FACP must be mounted in an accessible position as agreed with the end user and local requirements. The unit must not be mounted in another enclosure or near sources of excessive heat. The FACP is intended for indoor, dry use only.

Once the location has been agreed the location for the panel must be a dry, flat surface, level and in a position so that the enclosure is not distorted

Fixing the Cabinet

5mm screws or M5 bolts and any additional appropriate hardware for the fixing substrate must be used for mounting the cabinet-box in all four hole-mounting positions. Using the box as a template, mark the position of the fixing holes, ensuring that the wall is flat at the chosen location.

Mark hole locations on the premises-wall for mounting the empty cabinet of the FACP. The FACP is supplied in standard and deep size cabinet styles.

The figure below illustrates dimensions of the standard and deep size cabinet:

Figure 2-10
Standard and Deep Size Cabinet

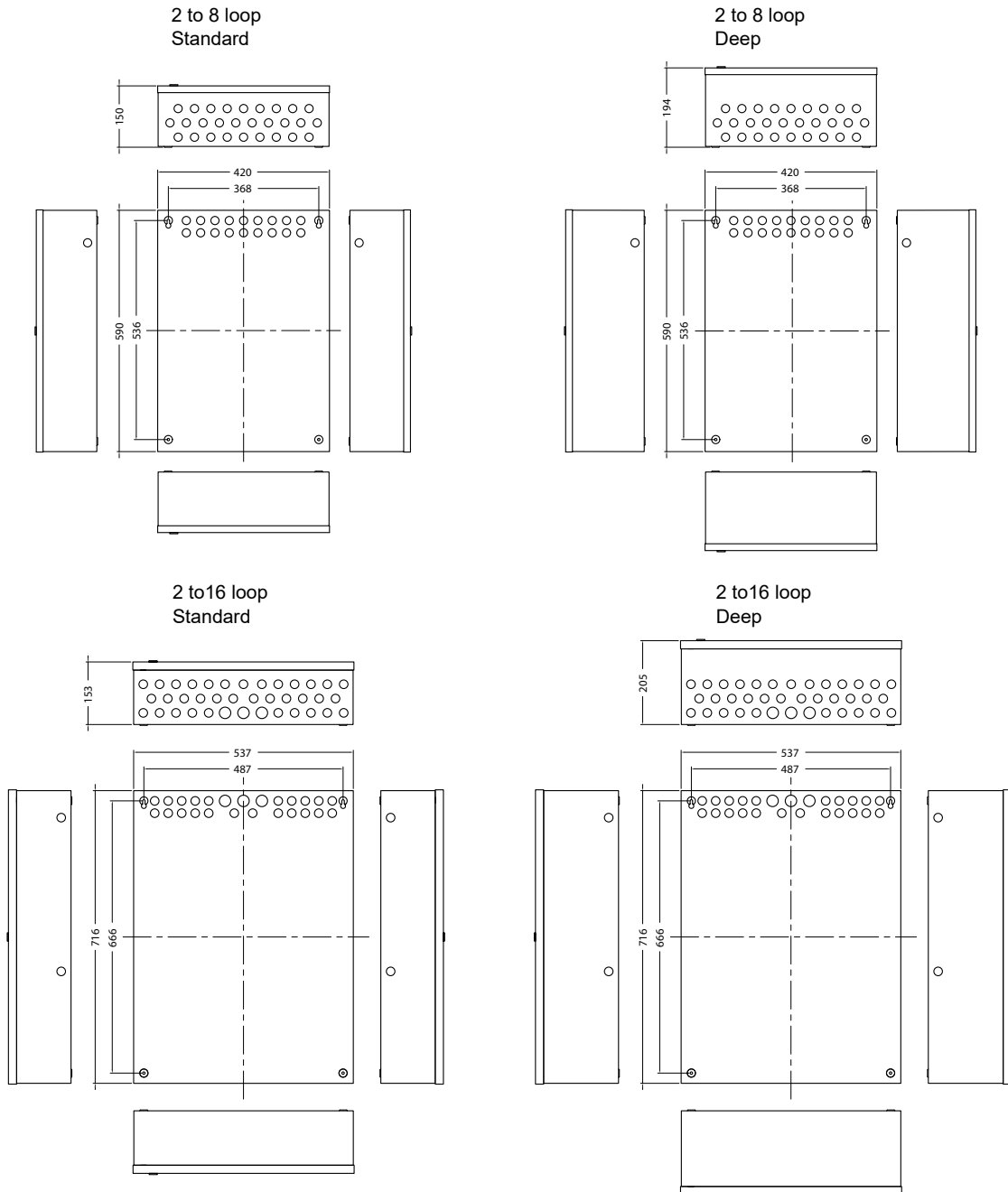

Drill four holes in the premises-wall according to appropriate dimensions identified above and then fix the empty cabinet to the wall using the mounting hardware to secure it.

Replacing Cabinet Components

Replace components to prepare for connecting power, system wiring and standby batteries.:

- 1 Replace the back-plate.
- 2 Replace the lid and fascia.
- 3 Fit and connect standby-batteries.
- 4 Connect and dress cabling.
- 5 Close and lock the lid.

Field Wiring

All wiring should enter the panel through the 20mm enclosure knock-outs, using appropriate cable glands. If additional cable entry points are required, all swarf and debris caused by drilling entries must be cleared before the system components are re-fitted and power is applied.

Fire Alarm System Wiring

Fire alarm system wiring should be kept separate from AC mains wiring (minimum gap 6.35mm). Refer to Appendices to determine specific operating constraints for devices and cabling connected to the FACP.

AC Mains wiring

AC Mains wiring should be kept separate from fire alarm system wiring (minimum gap 6.35mm). To reduce the impact of Electro-Magnetic Interference (EMI), the ferrite provided must be fitted to incoming mains wiring. The diagram below illustrates how the ferrite should be installed.

Figure 2-10
Installation of Ferrite

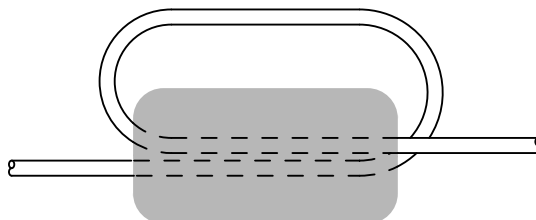

IMPORTANT! DO NOT connect mains wiring until after panel has been hung and reassembled with all printed circuit boards fitted.

IMPORTANT! Live and Neutral wire cores must be **doubled** around the ferrite. When the cores are in place close the ferrite with a 'click'.

Earth wiring must be connected directly to the earth enclosure terminals located at the top of the panel enclosure.

Figure 2-11
Enclosure Earth Terminals



Field Wiring Overview

- 1 Remove knock-outs from the cabinet according to the installation mounting requirements.
- 2 Fit appropriate cable gland/s to open knock-outs.
- 3 Introduce and terminate mains wiring and attach ferrite as described.
- 4 Introduce and terminate fire alarm system wiring.

Power Supplies

The panel is equipped with either a 5.25 Amp or a 10.25 Amp Power Supply. These power supplies can be set to operate at inputs of 115 VAC or 230 VAC. Both power options include standby battery operation. Set Dip Switches on the 5.25 Amp and 10.25 Amp Power Supplies before completing the installation process. The power supply settings must be performed to establish the optimal charge current for the standby-batteries.

The 5.25 Amp Power Supply

The 5.25 Amp Power Supply contains a jumper setting for changing from 115 VAC to 230 VAC. Check the jumper setting prior to wiring and operating the 5.25 Amp Power Supply with the FACP.

WARNING!



Ensure Jumper-J1 has been removed before operating the FACP at 230 VAC. Failure to remove Jumper-J1 prior to operating at 230 VAC will cause permanent damage to the 5.25 Amp

WARNING!



DANGER: High Voltage present on jumper pins. Remove AC power before changing jumper setting.

The figure below illustrates the location of jumper-J1 on the 5.25 Amp Power Supply of the FACP:

Figure 2-12

Jumper-J1 of the 5.25 Amp Power Supply

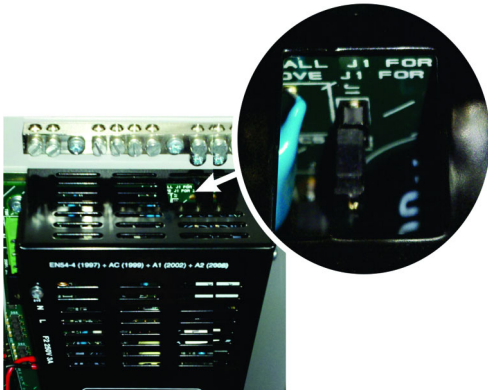

To provide 230 VAC operation, remove jumper-J1 from the circuit-board of the power supply.

To provide 115 VAC operation, connect jumper-J1 to the circuit-board of the power supply.

Provide an AC power connection to terminal block TB6. Protect AC power to branch circuits with a 20 Amp anti-surge-fuse and include an accessible disconnect device or isolation switch.

Connecting 24V and Host I/F Wiring

To connect 24V wiring of the 5.25 A or 10.25 A Power Supply to the Main Back Board:

- 1 Connect the red wire from the positive (+) 24V terminal of the power supply, to the 'PWR A' positive (+) terminal on the Main Back Board.
- 2 Connect the red wire from the negative (-) 24V terminal of the power supply, to the 'PWR A' negative (-) terminal on the Main Back Board.

Connect the ribbon cable from the Host I/F J5 connector of the power supply to the J18 connector of the Main Back Board to connect Host I/F wiring of the power supply to the Main Back Board. The figure below illustrates the 24V and Host I/F wiring connections of the 5.25 Amp Power Supply:

Figure 2-13
Connecting 24V and Host I/F Wiring of the 5.25 A Power Supply



Terminal connections of 24V and Host I/F are identical on the 10.25 A Power Supply and the 5.25 A Power Supply.

To connect AC power to the 5.25 Amp Power Supply:

- 3 Connect a wire from the ground-terminal of TB6 to the ground-stud-terminal of the cabinet-box.
- 4 Connect a wire from the ground-stud-terminal of the cabinet-box to an earth-ground. Provide this earth-ground connection in close proximity to the cabinet-box.
- 5 Connect a wire from the neutral-terminal (N) of TB6 to the neutral of the power-source.
- 6 Connect a wire from the line-terminal (L) of TB6 to the line of the power-source.

The figure below illustrates AC connections of the 5.25 Amp Power Supply:

Figure 2-14
AC Power Connections of the 5.25 Amp Power Supply



Dip Switches are located on the outer edge of the 5.25 Amp Power Supply. Dip switches of the 5.25 Amp Power Supply are located in a similar location as the 10.25 Amp Power Supply.

The figure below illustrates the location of Dip Switches on the 5.25 Amp Power Supply:

Figure 2-15
Dip Switch Location

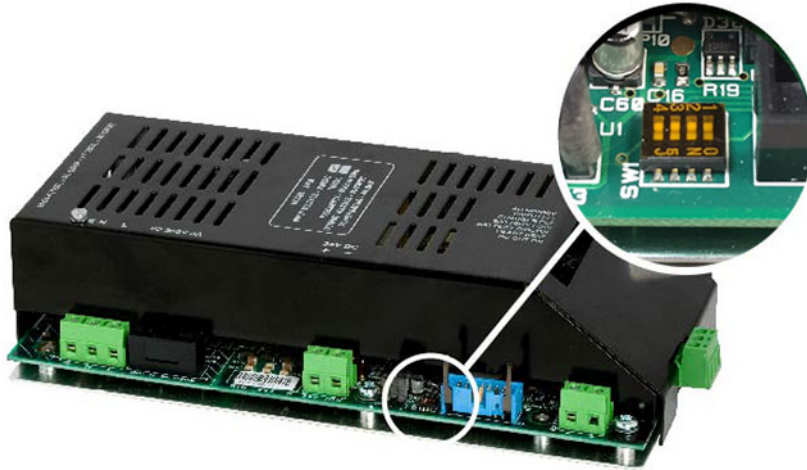
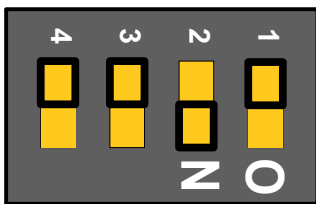

Figure 2-16
Dip Switch Position



In order to comply with requirements of EN54-4, Dip Switch 1 must be OFF and Dip switch 2 must be ON. Dip Switch 3 settings must be in the OFF position when powering fire alarm detection and control equipment. Dip Switch 4 is dependent upon the battery type used, if Yuasa batteries are used then Dip Switch 4 should be off, as shown:

The tables below describe Dip Switch settings 1 through 4 of the 5.25 Amp Power Supply.

Switch 1	Switch 2	Description
Off	Off	Recommended for standard operation
Off	On	EN54-4 compliant
On	Off	Disable fault reporting of disconnected standby-batteries
On	On	Disable fault reporting of the standby-battery impedance test

Switch setting 3 is not used on the 5.25 Amp Power Supply.

Switch 4	Description
On	Sets standby-batteries for the Powersonic manufacturer.
Off	Sets standby-batteries for the Yuasa manufacturer.

The 10.25 Amp Power Supply

Unlike the 5.25 Amp Power Supply, the 10.25 Amp Power Supply does not require a jumper to switch between 115 VAC and 230 VAC. The 10.25 Amp Power Supply provides an auto detect feature that automatically compensates for input voltages of 115 VAC or 230 VAC.

Provide an AC power connection to terminal block TB6. Protect AC power to branch circuits with a 20 Amp anti-surge-fuse and include an accessible disconnect device or isolation switch.

To connect AC power to the 10.25 Amp Power Supply:

- 1 Connect a wire from the ground-terminal of TB6 to the ground-stud-terminal of the cabinet.
- 2 Connect a wire from the ground-stud-terminal of the cabinet-box to an earth-ground. Provide this earth-ground connection in close proximity to the cabinet-box.
- 3 Connect a wire from the neutral-terminal (N) of TB6 to the neutral of the power-source.
- 4 Connect a wire from the line-terminal (L) of TB6 to the line of the power-source.

Figure 2-17
Dip switches of the 10.25A Power Supply

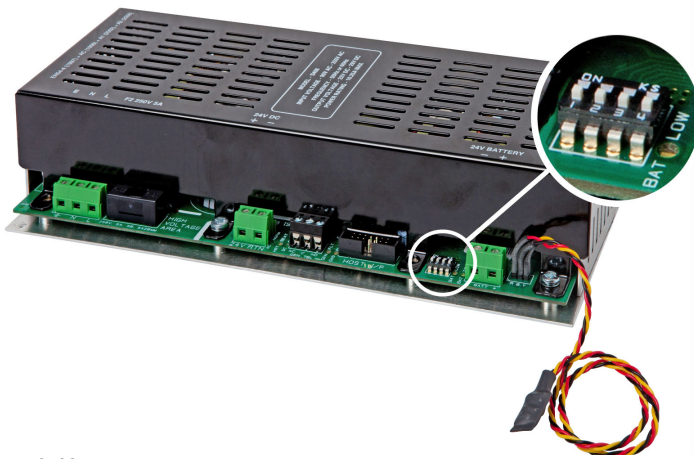
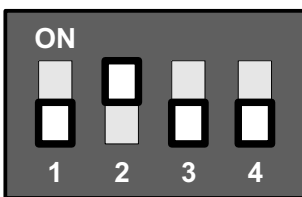

Figure 2-18
Dip Switch Position



In order to comply with requirements of EN54-4, Dip Switch 1 must be OFF and Dip switch 2 must be ON. Dip Switch 3 settings must be in the OFF position when powering fire alarm detection and control equipment. Dip Switch 4 is dependent upon the battery type used, if Yuasa batteries are used then Dip Switch 4 should be off, as shown.

The tables below describes Dip Switch settings 1 through 4 of the 10.25 Amp Power Supply:

Switch 1: Operating Mode	Description
On	Special Application Mode.
Off	EN54-4 Compliant recommended for standard operation
Switch 2: Ground Fault Detection	
On	Static: Setting required for interfacing to legacy products. Earth is pulled to a static voltage between 24V and RTN (1/2 of 24V-OUT).
Off	Dynamic: Ground-fault detection setting for specific loop devices. Earth is pulled to a dynamic cycling voltage ranging from 1/4 to 3/4 of 24V-OUT.
Switch 3: Battery Size	
On	Sets standby-battery capacity ≤ 18 Ah.
Off	Sets standby-battery capacity > 18 Ah.
Switch 4: Battery Manufacturer	Description
On	Sets standby-batteries for the Powersonic manufacturer.
Off	Sets standby-batteries for the Yuasa manufacturer.

Disabling Battery Indication

Set Dip Switch 1 to the ON position, Dip Switch 3 to the ON position and Dip Switch 4 to the OFF position to disable the disconnected warning indication and to disable operation of the common fault relay.

Disabling the Impedance Test

Set Dip Switch 1 to the ON position and Dip Switch 3 to the OFF position to disable the battery impedance test and fault reporting.

Special Application Mode Table

SW 1	SW 2	SW 3	SW 4	Battery Mfr.	Battery Size	Ground Fault Detection	Impedance Test Intervals	Battery Missing Fault
ON	ON	ON	ON	Reserved for future use.....				
ON	OFF	ON	ON	Reserved for future use.....				
ON	ON	OFF	ON	Powersonic	Large	Static	Disabled	Reported
ON	OFF	OFF	ON	Powersonic	Large	Dynamic	Disabled	Reported
ON	ON	ON	OFF	Yuasa	Small	Static	1 min	Masked
ON	OFF	ON	OFF	Yuasa	Small	Dynamic	1 min	Masked
ON	ON	OFF	OFF	Yuasa	Large	Static	Disabled	Reported
ON	OFF	OFF	OFF	Yuasa	Large	Dynamic	Disabled	Reported

Light shading of the table indicates “production” or “demo” use. Dark shading of the table indicates a “normal, but impedance test disabled” use.

Supplementary Power Supply

On systems and where the current load and standby times exceed the capability of the integral power supply, a supplementary power supply can be introduced.

Typically terminals **PWR B** (0V and 24V) found on the main back board are allocated for a supplementary power supply.

Figure 2-19
Power and Supplementary Power Supply Terminals

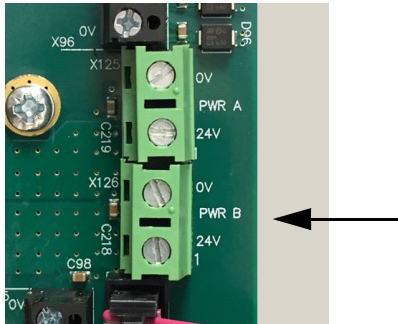

Any supplementary power supply must meet the following criteria:

- Have sufficient current output to meet system requirements.
- Have a supply voltage of 24V DC.
- Any additional power supply must be EN54-4 compliant.
- Installed in compliance with current codes of practice.

PWR terminal inputs are ‘floating’ if not linked, therefore environmental noise factors within the panel may affect the state of the input where you may or may not get a ‘Power Fault’ condition reported.

- Please **link** to ensure any open PWR input is powered to overcome any noise factors affecting its input.
- Please **unlink** if both PWR A and PWR B inputs are connected to PSU’s.

Production standard build provides link wires between PWR A 24V to PWR B 24V & PWR A 0V to PWR B 0V. The panel’s internal PSU is normally connected to PWR A 24V and 0V.

The diagram below illustrates both configuration scenarios.

Figure 2-20
PWR Configurations

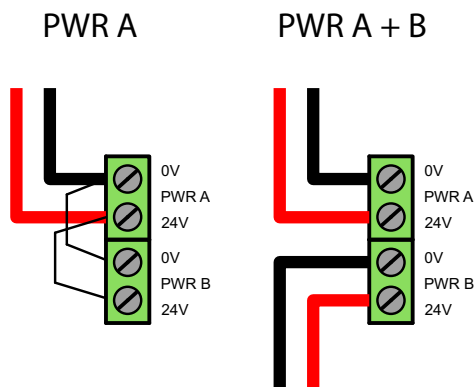

Circuit Boards

Circuit Boards of the FACP are installed at the factory according to customer requirements. In some situations it may be necessary to install additional circuit boards to satisfy fire safety requirements. This section describes procedures for installing and configuring circuit boards of the FACP.

CAUTION!



the FACP installation must be performed by qualified personnel familiar with electronic components. Electronic components within the FACP are vulnerable to damage from electrostatic discharge. Ground straps must be worn by installers before handling FACP circuit boards to prevent damage from electrostatic discharge.

Slot-Assignments

Populate slots of the Main Back Board so that Slot A contains the System Board A Module, Slot B contains the System Board B Module and Slots C, D, E or F contain the Dual Loop Module. Optional circuit boards and assemblies can populate slots D, E and F of the Main Back Board.

The figure below illustrates slots-assignments of the Main Back-Board:

Slot-Assignments of the Main Back-Board

Figure 2-21
Slot-Assignments of the Main Back Board

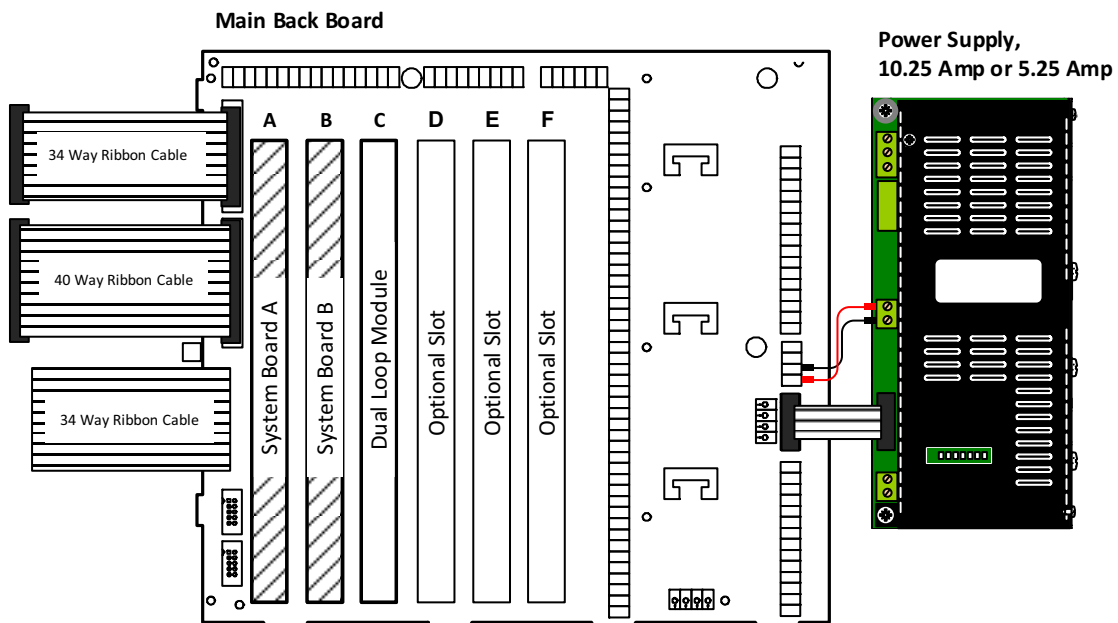

Slot Assignments

 = Required Slot-Assignments  = Optional Slot-Assignments

The Main Back Board contains connector slots A through F. Operation of the FACP requires that one Dual Loop Module is fitted in slots C, D, E or F to meet minimum operating requirements. The Dual Loop Module can be fitted in slots C, D, E or F of the Main Back Board. Slot C of the Main Back Board is the factory location for the Dual Loop Module connection.

Figures contained in this manual illustrate the Dual Loop Module in slot C of the Main Back Board.

Connecting the LCD Main Processor Board

The figure below illustrates connections of the LCD Main Processor Board:

Figure 2-22
Connecting the LCD Main Processor Board

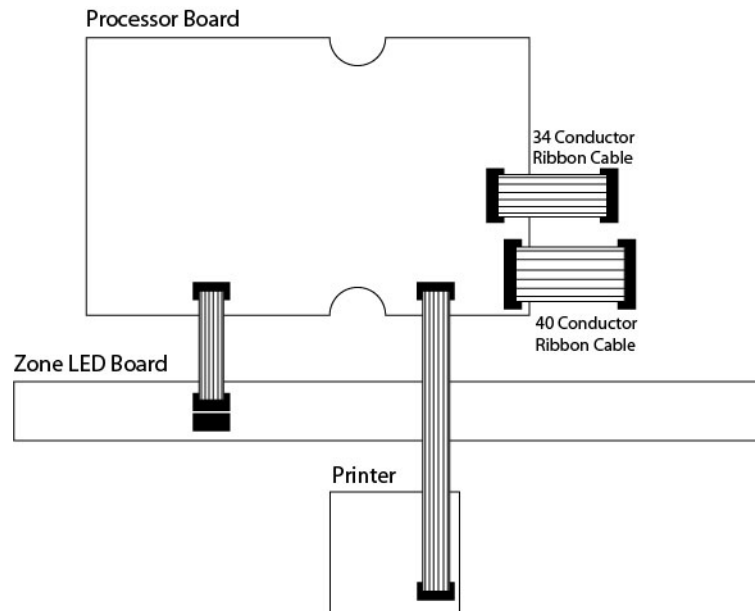

The *fixed* LCD Main Processor Board, *optional* Zone LED Board and *optional* Printer are mounted on the cabinet-lid of the FACP.

The LCD Main Processor Board can operate a maximum of three Zone LED Boards within a standard enclosure. One Zone LED Board provides 48 LED indicators. Three LED Zone Boards provide 144 LED indicators.

Up to three zone LED boards each containing 48 LEDs can be fitted per FACP. Zone LED boards connect to the Main processor board J28 through a 10-way ribbon cable connected to J1 on the zone LED board.

Subsequent zone LED boards daisy chain to the through 10-way ribbon cables. J2 is the connection out and J1 is the connection in on each zone LED board. Each Zone LED Board contains 48 zone LED indicators that can be daisy chained to provide more than 144 Zone LED indicators.

Installing Circuit Boards

To install circuit boards on the FACP:

- 1 Remove power at the mains and disconnect standby-batteries prior to performing the circuit board installation.
- 2 Remove the retaining-screw from the cover and then remove the cover from the Chassis.

Figure 2-23
Removing the Chassis Cover



- 3 Remove the circuit board from the protective packaging using adequate electrostatic protection.
- 4 Point the conductor side of the circuit board toward the Chassis.
- 5 Grasp the circuit board using an index-finger and thumb at the top-corner opposite the conductor-side.
- 6 Insert the notched-end of the circuit board in the metal guide of the backplane at a 45 degree angle.

Figure 2-24
Inserting Circuit Boards in the Chassis

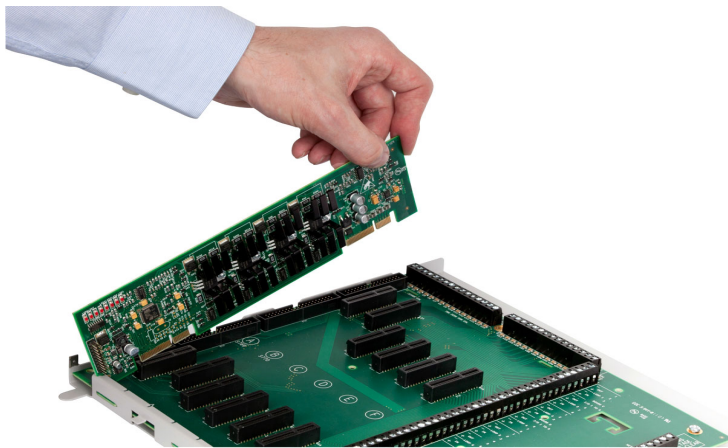

- 7 Rotate the circuit board until all conductors are securely inserted into connectors of the Chassis.

The figure below illustrates the secure position for circuit boards in the Chassis:

Figure 2-25
Secure Position for Circuit Boards in the Chassis

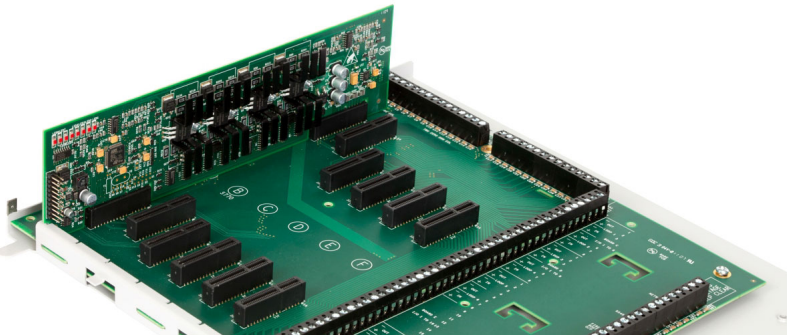

Refer to Section 4, Maintenance for instructions describing the removal of circuit boards.

Optional Circuit Boards DIP Switch Settings

Each optional circuit boards of the FACP must have it DIP switch set between address 1 and 32 before being fitted to the Main Back Board. The binary setting of the DIP switch conforms to a specific address location on the Main Back Board.

The numeric order of the address setting between circuit boards does not impact operation but, each circuit board must be assigned a unique address.

The figure below illustrates binary addresses 1 to 32.

Figure 2-26
Binary Addresses

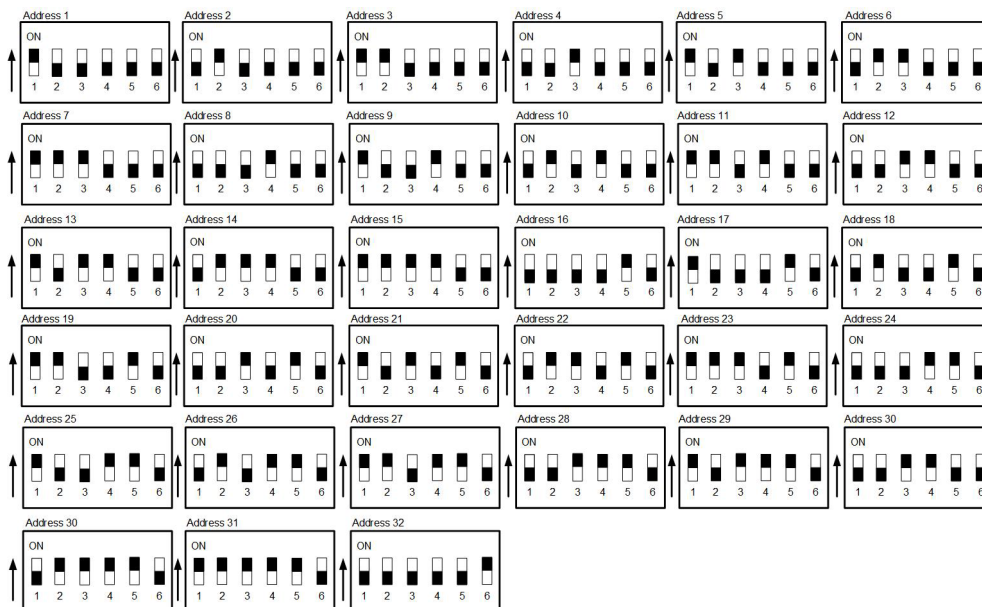

DIP Switch Settings

An address of 7 is set when actuators of the DIP switch are “up” on positions 1, 2 and 3. These settings identify:

- 2^0 for switch position 1, where $2^0 = 1$
- 2^1 for switch position 2, where $2^1 = 2$
- 2^2 for switch position 3, where $2^2 = 4$

The binary address for this DIP is $1 + 2 + 4 = 7$

The figure below illustrates settings for an address of 7 on the DIP switch:

Figure 2-27
DIP Switch Settings

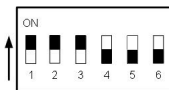

Loop Circuit Boards DIP Switch Settings

Each Loop circuit boards of the FACP must have it DIP switch set between address 1 and 4 before being fitted to the Main Back Board. The binary setting of the DIP switch conforms to a specific address location on the Main Back Board.

Figure 2-28
DIP Switch Settings



Field Terminal Assignments

Circuit board slot positions on the Main Back Board correspond to specific field terminal locations on the Main Back Board:

Slot Positions	Field Terminal Location
C	Addressable Loops 1 and 2 or Additional Boards
D	Addressable Loops 3 and 4 or 8 Additional Boards
E	Addressable Loops 5 and 6 or Additional Boards
F	Addressable Loops 7 and 8 or Additional Boards

Refer to *Additional Boards Installation Manual (Man-1170)* regarding Additional Board options and specifications.

System Board A Module must connect to slot position A on the Main Back Board and System Board B Module must connect to slot position B on the Main Back Board. Note that these two cards do not have any address DIP switch

The figure below illustrates slot position and field terminal assignments on the FACP, all wiring should be connected to the Field Wiring Terminal Blocks on the Back Board shown below and NOT on any of the individual cards.

Figure 2-29
Slot Position and Field Terminal Assignments

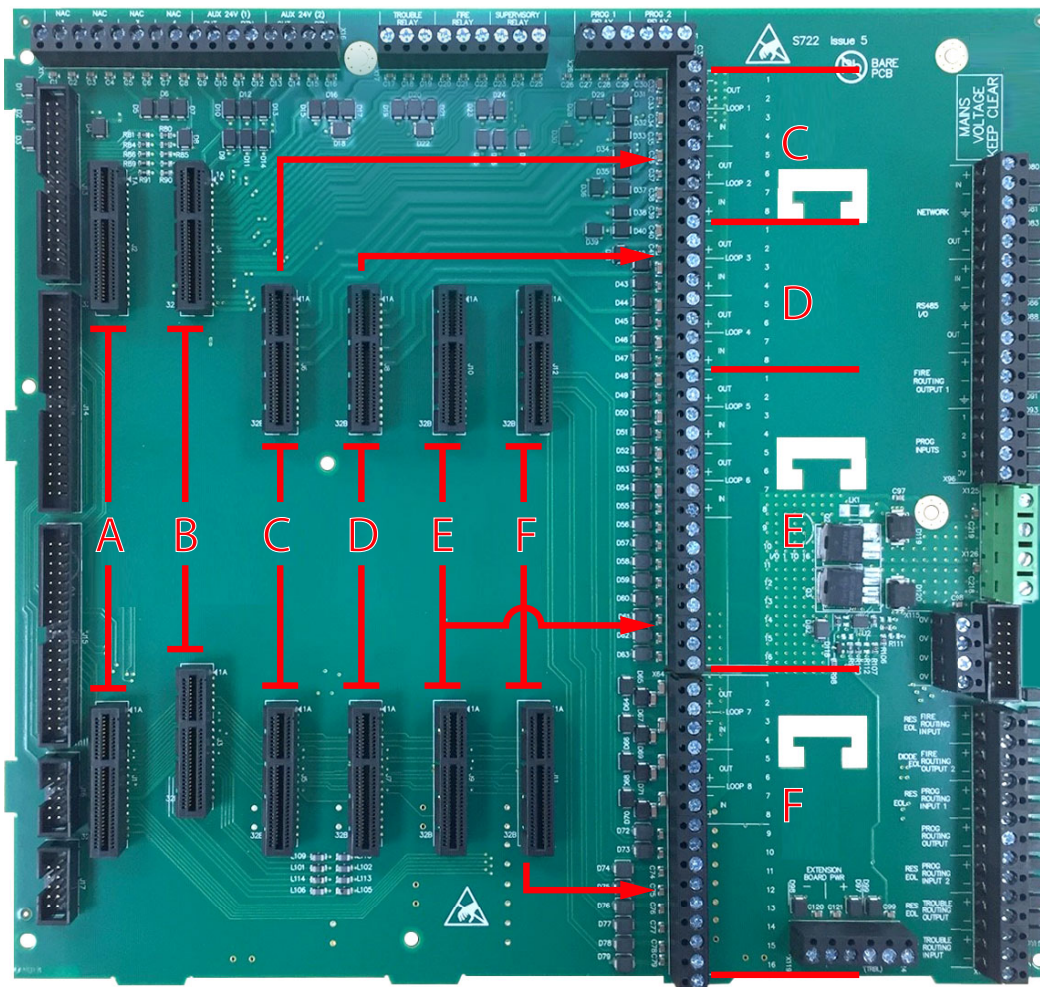

Installing Communication Modules (Networking)

Communication Modules of the FACP operate with pre-loaded software and are non-configurable through the menu or through Loop Explorer.

To install communication modules of the FACP:

- 1 Switch off power at the mains.
- 2 Open the lid of the FACP so that the LCD Main Processor Board is accessible.
- 3 Plug in the 40-pin female-connector of the communication module to the 40-pin male-connector of the LCD Main Processor Board. The 40-pin female-connector of the communication module is located on the trace-side of the circuit board.
- 4 Secure the communication module to the LCD Main Processor Board with supplied screws and lock washers in three locations.
- 5 Close the lid of the FACP and apply mains power.

Network Connections

Provide network connections to NETWORK IN and NETWORK OUT of the FACP after installing the Network Module and the Network, Ethernet & IFAM Interface Module.

The figure below illustrates network connections of the FACP:

Figure 2-30
Network Connections of the FACP

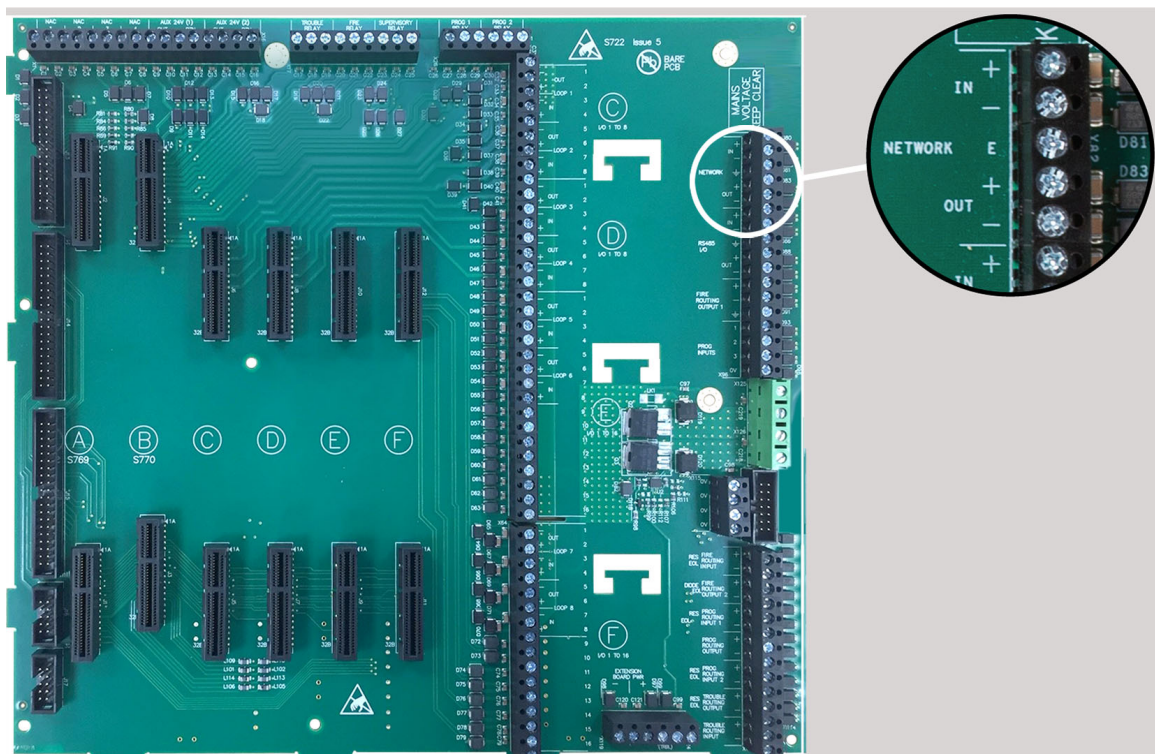

IFAM Connections

Provide IFAM connections to the Fire Routing O/P terminals of the FACP after installing the Network, Ethernet & IFAM Interface Module.

The Network, Ethernet & IFAM Interface Module provides RS485 communications to the Fire Routing O/P terminals of the Main Back Board when configured. This configuration provides half duplex RS485 connection.

Connecting Loop Circuits

Connect Loop circuits to terminal-strip X32 of the FACP. Terminate unused Loops of the FACP with zero-ohm shorting-jumpers. Connect zero-ohm shorting-jumpers on the FACP from Loop 1 OUT (-) to Loop 1 IN (-) and Loop 1 OUT (+) to Loop 1 IN (+). the FACP provides a fault signal when unused loops are not terminated. Addressable loops 1 through 8 of the FACP are monitored.

The figure below illustrates loop connections on Loop 1 of the FACP:

Figure 2-31
Loop Connections

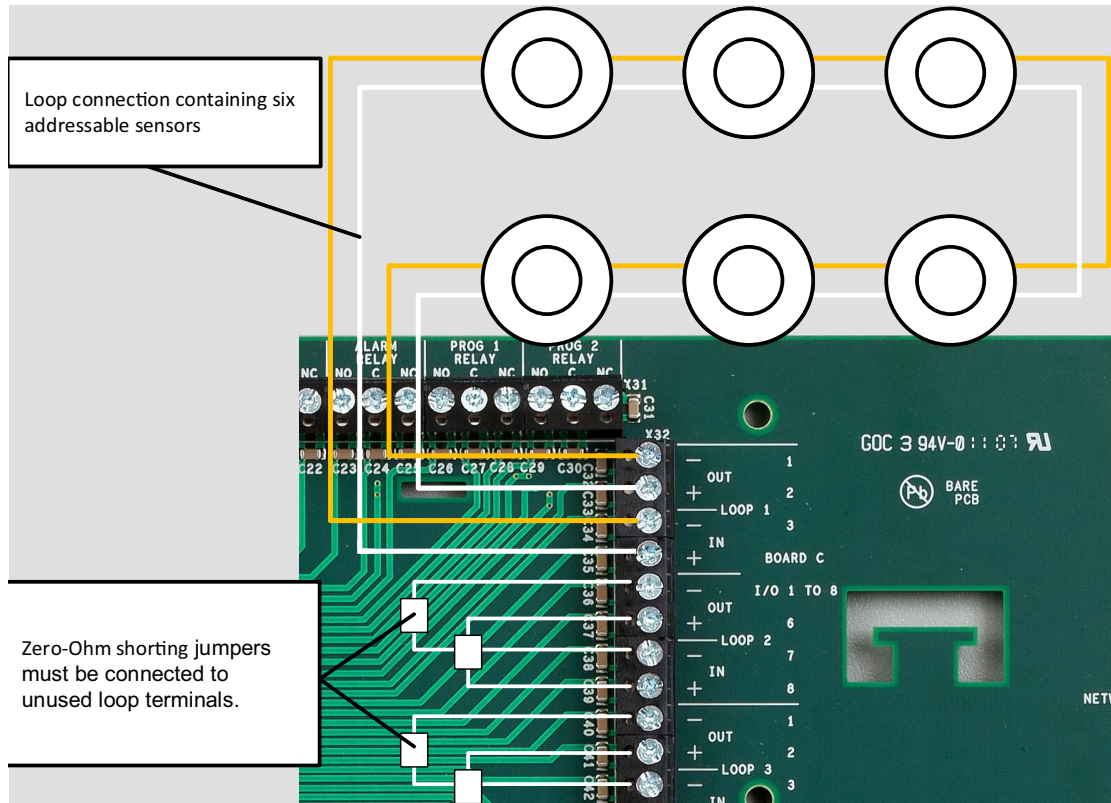

Refer to manufacturer specifications for Sensor connections.

Connecting Spur Circuits

Spur circuits may not be permitted in all regions. Check local codes of practice before using Spur detection circuit configurations.

Connect Spur circuits to terminal-strip X32 of the FACP. Terminate unused loops of the FACP with zero-ohm shorting-jumpers. Connect zero-ohm shorting-jumpers on the FACP from OUT (-) to IN (-) and OUT (+) to IN (+). The FACP provides a fault signal when unused loops are not terminated.

The figure below illustrates Spur connections on loop 1 of the FACP.

Figure 2-32
Spur Connections

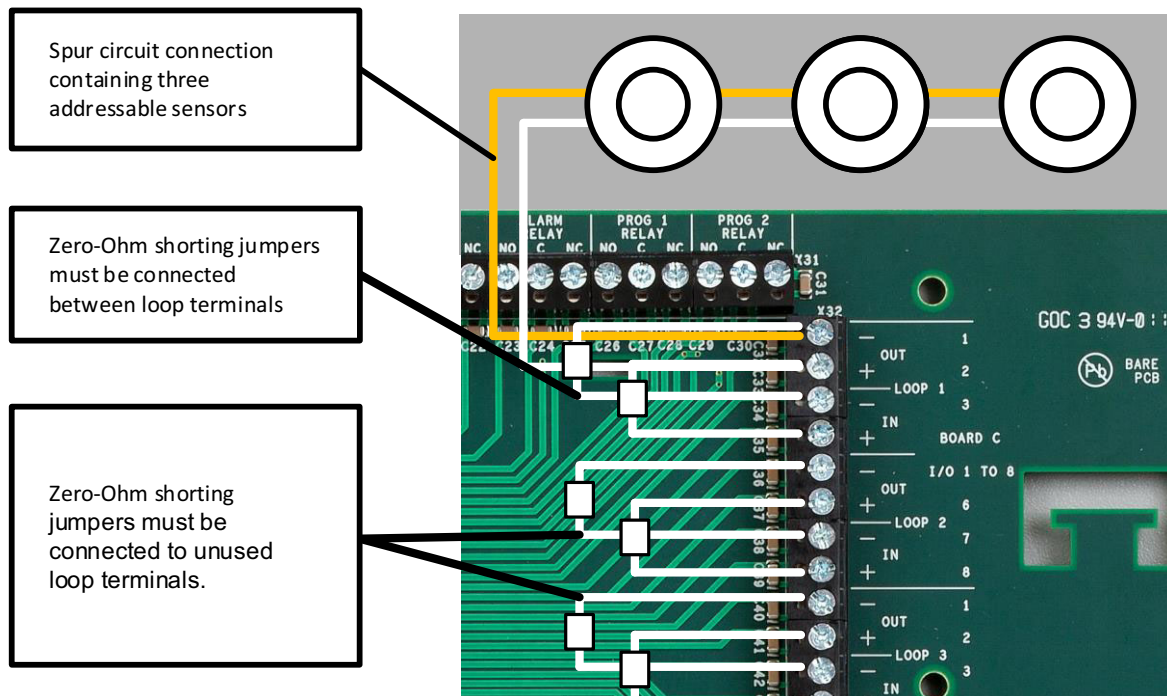

Refer to manufacturer specifications for Sensor connections.

The loop termination jumpers shown are provided in Resistor Kit (8) Zero Ohm.

Refer to Appendix, for wire gage and length requirements for Loop and Spur Addressable circuit loops.

Wire detection-loop-circuits of the FACP according to cable-length and circuit-load and then ensure that the voltage drop of the cable does not exceed the minimum operating voltage of the circuit-devices. The amount of Detection-loop-circuits that can be supplied for operating addressable sounders and beacons.

Installing Addressable Devices

This section describes installation requirements and constraints for addressable devices on the FACP. The addressable devices described in this section include detectors, addressable sounders and Additional Boards.

Detector Spacing

Install addressable detectors with minimum spacing requirements specified in local codes of practice.

Detector Sensitivity

Detector sensitivity can be set at different levels and for certain periods. Sensitivity levels should be determined and planned in advance.

Activation Period

Detector sensitivity and calibration can be set once in a twenty-four hour period. A setting is also available for limiting the annunciation time of the sounder assigned to the detector.

Refer to Section 4, Operation for functional details concerning the Activation Feature of the FACP:

Detection Loop Sounders and Output Boards

Install addressable sounders so not more than one sounder zone is affected by a fault condition. Install detection loop devices of the FACP containing one of the following methods to meet this requirement:

- Perform an addressable loop installation that does not contain output devices.
- Perform an addressable loop installation where output devices are in one zone.
- Perform an addressable loop installation where output devices are in different zones.

Loop installations require that an isolator is fitted to every twentieth loop device in the circuit and where loops cross through zone boundaries.

Connecting Sounder Circuits

the FACP includes four programmable sounder outputs S1, S2, S3 and S4. The amount the sounder circuits can drive is in the specification section. The sounder outputs are set to operate continuously in any fire condition as a default condition. All sounder outputs can be configured to operate in a different configuration.

Sounder outputs can be configured in pairs for loop circuit operation. Loop circuit operation can be assigned to a single pair such as S1, S2 or both sounder outputs containing pairs S1, S2 and S3, S4.

For Spur operation, the end of line device fitted in the terminals of the control panel must be removed from the panel and fitted across the terminals of the last device on the sounder circuit.

Wiring of the sounder circuit must be sized according to the cable-length and the sounder load to ensure that voltage drop of the cable does not exceed the minimum operating voltage of the connected-devices.

Different limitations will apply for devices with a higher or lower minimum operating voltage.

To install Sounders on the FACP:

- 1 Connect Sounders and End-Of-Line-Devices to the Sounder channel.
- 2 Connect End-Of-Line-Devices to unused Sounder channels.
- 3 Maintain the limit for maximum wire length of the Sounder circuit.

The figure below illustrates a connection example of a spur Sounder circuit:

Figure 2-33
Spur Sounder Circuit Example

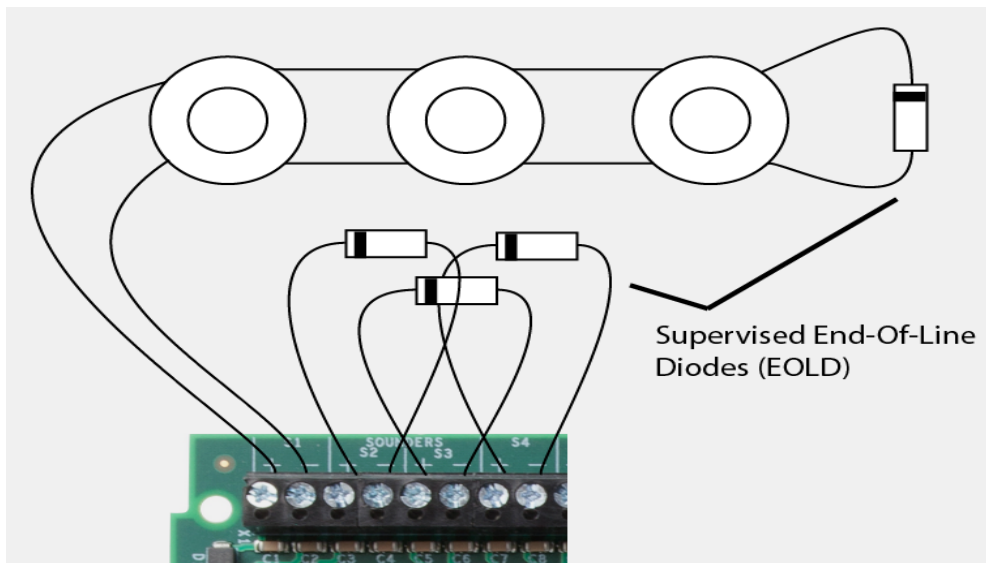

Synchronised device connections to the FACP require special conditions when installing audible and visual Sounders:

- Audible Devices** The installation of synchronised-audible sounders on one sounder output shall not be installed in hearing range of another group of synchronised-audible sounders on another sounder output.
- Visual Devices** The installation of synchronised-visual sounders on one sounder output shall not be installed in line-of-sight of another group of synchronised-visual sounders on another sounder output.

AUX 24V 1 and AUX 24V 2

AUX 24V 1 and AUX 24V 2 are 24V DC outputs for powering ancillary devices such as loop modules, I/O boards and relays. Outputs of AUX 24V 1 and AUX 24V 2 are also monitored for circuit fault conditions.

Circuits operating on AUX 24V 1 and AUX 24V 2 must be sized according to cable-length and device load to ensure that voltage-drop of the cable does not exceed the minimum operating voltage of connected-devices.

Connect the + M and - M terminals of AUX 24 (1) or AUX 24 (2) when requiring open circuit monitoring of an auxiliary 24 VDC power source.

For Aux 24V 1 and Aux 24V 2 specification refer to Specification Appendix.

Relay Contacts

the FACP contains five programmable relays that provide volt free changeover on terminal strip X1.

These relays include:

- FAULT RELAY** This relay activates on any fault and clears when faults are cleared.
- FIRE RELAY** This relay activates on any fire condition and remains active until panel is reset.
- ALARM RELAY** This relay activates on any alarm and de-activates when the alarm condition is silenced and acknowledged.
- PROG 1 RELAY** This relay is closed for 5 seconds when the reset button is pressed under default conditions.
- PROG 2 RELAY** This relay is closed for 1 second during every new fire event and occurs under default conditions.

Each volt free changeover contact can be configured independently through the PC configuration program or the touch-panel-display using Access Level 3. This includes delays as described for Sounder Circuits.

Fire Routing O/P

The Fire Routing O/P connection provides connections on terminals (+), (-) and (E) of the horizontal terminal-strip Y-1. Connect the screen of the Fire Routing I/O cabling to the E terminal of the Fire Routing O/P connection. The screen of the Fire Routing I/O cabling is the cabling earth connection.

Connect only compatible devices to this monitored output. The Fire Routing output is monitored for open and short-circuit fault conditions when using an End Of Line Resistor.

The Fire Routing output is protected by a self-resetting-fuse. Connect only polarized circuits to this voltage reversing output. A suppression diode must be fitted to the Fire Routing O/P circuit when the circuit includes a relay. The suppression diode suppresses interference generated by the relay when it operates.

Configure this output using the touch screen menu of the FACP. Set configurations in the touch screen menu to operate and monitor devices connected to this output.

The figure below illustrates an example of a Fire Routing output containing a relay circuit:

Figure 2-34
Fire Routing and Fault Routing

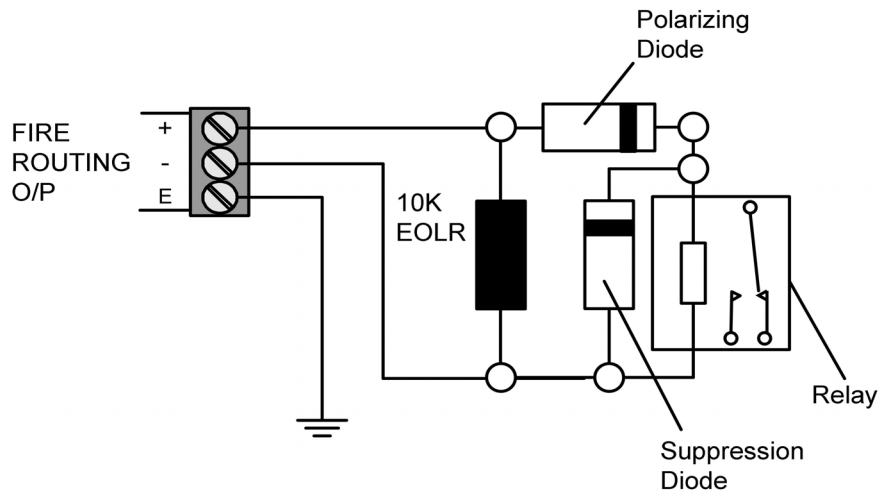

Programmable Inputs

Programmable Inputs (PROG I/P) of the FACP contain three programmable inputs and one 0 volt terminal. The programmable inputs are non-monitored and are activated by voltage free contacts. Connect the 0V terminal to the Prog I/P terminal in the circuit to activate the programmable function.

All inputs are non-latching as a default condition of the FACP. The line impedance of the circuit connection to the Prog I/P terminals must be less than 50 ohms.

The three programmable inputs can be configured to provide separate actions, delays, zones and location messaging using the menu of the touch panel display.

Terminals of the PROG I/P are located on vertical terminal-strip-Y1 and are designated:

Terminal	Designation	Condition
1	P1 -Programmable 1	on / off
2	P2 -Programmable 2	on / off
3	P3 -Programmable 3	on / off
4	0V	0 volts

The figure below illustrates the PROG I/P terminals:

The PROG I/P Terminals
Figure 2-35



Operating and installing the Printer

The Printer is an optional feature for printing live or logged fire-system-events. The Printer is located on the fascia, below Zone LED's of the FACP.

The Printer is a thermal printer and therefore never requires replacement ink. Printing of the Printer is performed on heat-sensitive paper-rolls. The paper-rolls are accessible from the fascia of the FACP.

A fault message is reported on the touch-panel-display of the FACP when paper-rolls of the Printer are exhausted. The Printer includes a front loading feature for replacing paper-rolls.

Installing the Printer

The Printer is installed on the FACP as an optional feature.

Installation of the Printer is not necessary when it is included on the FACP. However, it may be necessary to replace the Printer over the course of the operating life of the FACP.

Installation instructions from the manufacturer are supplied with the Printer.

The following section describes procedures for installing the Printer:

To install the Printer on the FACP:

- 1 Remove the Printer from the packaging and then remove any shipping material covering the assembly.

Figure 2-36
Removing From Packaging



- 2 Orient the Printer with the cable and circuit board side facing the lid of the FACP.
- 3 Insert the cable and circuit board side of the Printer in the lid opening of the FACP.
- 4 Plug the cable of the Printer in the PRINTER connector on the LCD Main Processor Board.
- 5 Fix the Printer assembly in place on the lid using plastic rivets.

Loading Paper Rolls

To load paper rolls in the Printer:

- 1 Lift the latch on the face of the Printer to access the paper chamber.
- 2 Load the paper in the paper chamber with the paper edge exiting from the top and with the shiny-side facing the top of the FACP.
- 3 Press the << button on the face of the printer to test feed the paper.

Installing Standby-Batteries

A panel fitted with the 5.25A Power Supply is capable of charging standby batteries up to 26Ah*.

A panel fitted with the 10.25A Power Supply is capable of charging standby batteries up to 45Ah*.

*Using Power-Sonic regulated sealed lead acid batteries.

CAUTION!



Battery terminal shorts can reduce the life of the standby-batteries and in extreme cases can cause harm to individuals. Do not permit battery terminals to short while connecting standby-batteries. Handle standby-batteries with care.

Standby-Battery Capacity

Determine the current consumption of the fire alarm system for alarm and standby conditions. Use these maximum current values to obtain the battery capacity of the fire alarm system.

Refer to Appendix for calculations for determining the battery capacity of the installed system.

Perform the installation only after calculations have been completed for a suitable battery size. Battery standby-hours are dependent on the required standby period and load of the FACP system

To connect standby-batteries of the FACP:

- 1 Place two 12 VDC, SLA, re-chargeable, standby-batteries in the base of the FACP cabinet.
- 2 Orient terminals of the standby-batteries so that the positive (+) terminal of one standby-battery is facing the negative (-) terminal of the other.
- 3 Connect the black wire of the power supply to the negative (-) terminal of Battery 1.
- 4 Connect the red wire of the power supply to the positive (+) terminal of Battery 2.
- 5 Connect the jumper-wire to the remaining positive and negative terminals of Battery 1 and Battery 2.

The figure below illustrates standby-battery connections of the 5.25 Amp Power Supply:

Figure 2-11
Connecting Standby-Batteries of the 5.25 Amp Power Supply



The series connection of the standby-batteries shown provides the 24 volts required to operate standby.

Do not connect standby-batteries in parallel. A parallel connection will not provide the 24 volts necessary to operate standby.

Optional Marine-Battery-Brackets

Install marine-battery-brackets when operating the FACP in marine environments. Marine-battery-brackets prevent movement of the standby-batteries in the cabinet of the FACP.

Two marine-battery-brackets are provided in the packaging of the FACP.

To install Marine-battery-brackets:

- 1 Place a marine-battery-bracket on top of one of the standby-batteries in the cabinet of the FACP.
- 2 Slide the marine-battery-bracket to the rear and align the appropriate Amp hour (Ah) through-hole with the fixing location in the rear of the cabinet.
- 3 Secure the marine-battery-bracket against the rear of the cabinet using screws provided in the packaging.
- 4 Repeat steps 1 through 3 for the second marine-battery-bracket and second standby-battery.
- 5 Place the battery strap across the face of both standby-batteries and secure it to the rear of the cabinet-box.

The figure below illustrates a marine-battery-bracket installation on the FACP.

Figure 2-12
Marine Battery Bracket

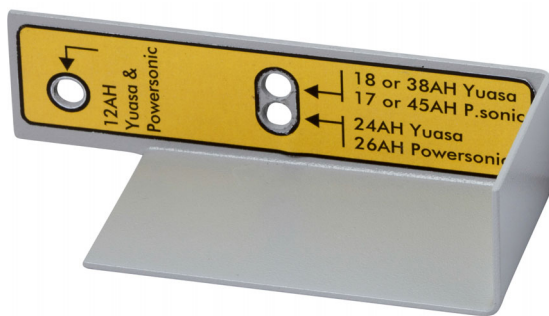

Section 3

Commissioning

Checks must be conducted prior to commissioning the FACP to ensure proper installation of the power supply and to confirm operation. These checks include tests of the Power Supply, Menu, Touch-Panel-Display and System Information.

Power Supply Checks

Perform the following inspections after completing connections and safety checks:

- 1 Apply AC power to the FACP from the mains.
- 2 Check that the AC Normal LED is illuminated on the Power Supply.
Refer to Section 2, Overview for Status Indicators of the Power Supply.
- 3 Check that the Heartbeat LED is flashing.
Refer to Section 1, Hardware Overview for Status Indicators of the Power Supply.
- 4 Remove the mains power and ensure that the standby-batteries are powering the FACP.

The AC Normal LED on the Power Supply switches off after 30 seconds to indicate the loss of mains power.

- 5 Apply AC power to the FACP from the mains.
- 6 Disconnect the red wire from the Standby-Battery terminal.

The Battery Disconnect LED on the Power Supply illuminates and the FACP continues to operate.

Re-check connections and then test voltages at the primary and secondary of the Power Supply if the FACP does not operate as described above.

Confirming Operation

Perform the following before testing the operation of the FACP:

- 1 Connect loops, sounder circuits, inputs and outputs to the control panel.
- 2 Confirm that correct connections exist between the batteries and the power supply.
- 3 Apply AC power to the FACP.
- 4 Perform the Learn Panel function on the touch-panel-display of the FACP.

Buzzer activation of the FACP occurs when performing the Learn Panel function. Buzzer activation during the Learn Panel function is part of configuring process and can be safely ignored.

The Learn Panel function tests for opens, shorts and ground faults and also provides configuration settings for external devices on field-terminals of the FACP.

During the Learn Panel function internal connections to field terminals of the FACP separate circuit-contact. the FACP is off-line when it separates contact with the field terminals.

While operating in the off-line state, the FACP provides a buzzer indication to signal a system fault condition. Buzzer activation during this process is consistent with the Learn Panel function and FACP operation.

- 5 Confirm that the Fire System Normal condition is displayed following the Autolearn sequence.

A "System" fault will occur after restarting the FACP. This is normal and is an EN54-2 requirement. This can be cleared by operation of the System Reset button on the touch screen display.

- 6 Perform Panel Tests of the FACP to check the internal buzzer, indicator lamps, touch-panel-display and the software.

Fire System Normal Test

The Fire System Normal display occurs when the FACP is operating properly and indicates that the installation was successful.

Determine that the Fire System Normal condition is visible on the touch-panel-display before initiating Panel Tests of the FACP. Fire System Normal condition is displayed on the touch-panel-display following the booting cycle and occurs when fault conditions are not reported to the FACP.

Figure 3-1
Fire System Normal

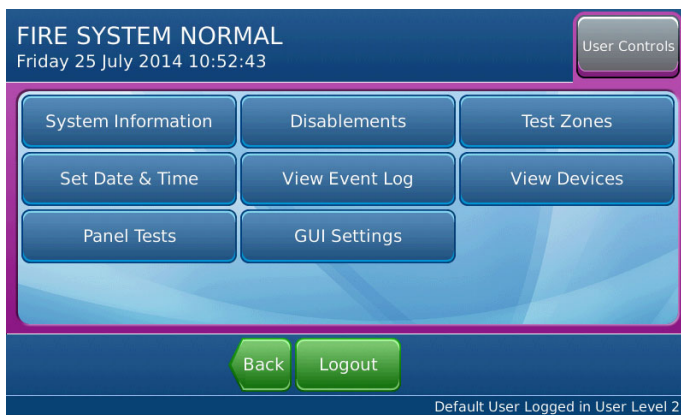

Panel Tests

Panel Tests are provided through No User Group of the fascia menu. No User Group contains a limited set of operations and does not require password authorization to initiate. The No User Group menu is immediately available for operation following the booting cycle of the FACP.

Perform Panel Tests for indicator lamps, buzzer, the touch-panel-display and the system information. Initiate these tests when troubleshooting the FACP for loss of operation concerning these areas.

Lamp & Buzzer Test

Perform the Lamp & Buzzer Test to confirm operation of indicator lamps and the buzzer of the FACP.

To perform the Lamp & Buzzer Test:

- 1 Press the touch-panel-display of the FACP during the Fire System Normal condition.
- 2 Press Panel Tests.
- 3 Press Lamp & Buzzer Test.

The internal buzzer of the FACP sounds and all indicator lamps light for 5 seconds. Contact the help desk if fascia lamps do not light.

Display Test

This test confirms operation of the touch-panel-display.

To perform the Display Test:

- 1 Press the touch-panel-display of the FACP during the Fire System Normal condition.
- 2 Press Panel Tests on the User Controls window.

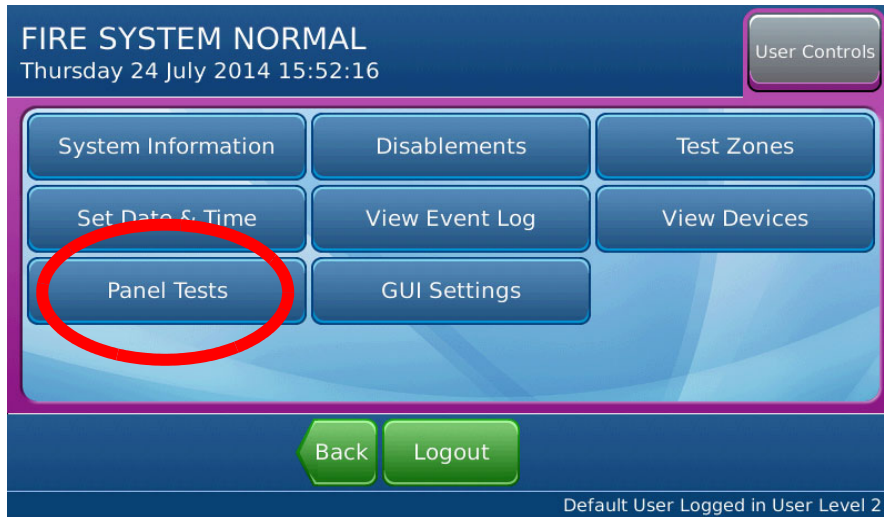

- 3 Press Display Test on the User Controls window.

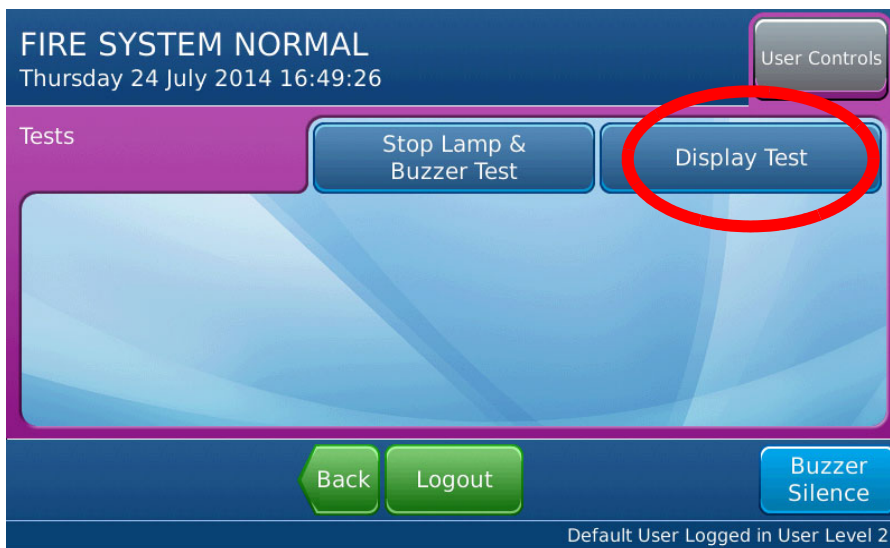

- 4 Press continue on the pop-up window.

The touch-panel-display cycles through a series of blank-raster colours.

Press the Lamp & Buzzer Test button to operate the internal buzzer and light all LEDs on the fascia of the FACP. Press the Display Test button to provide a series of blank raster colours on the touch-panel-display.

System Information

The System Information window includes details such as Software Version, File manager, LED Controller, I/O Board Controller, Configuration Manager and the Event Log.

View System Information to determine the operating status of the FACP.

To view system information on the FACP:

- 1 Press the Fire System Normal screen to open the User Controls window.
- 2 Press System Information to display the System Information window:

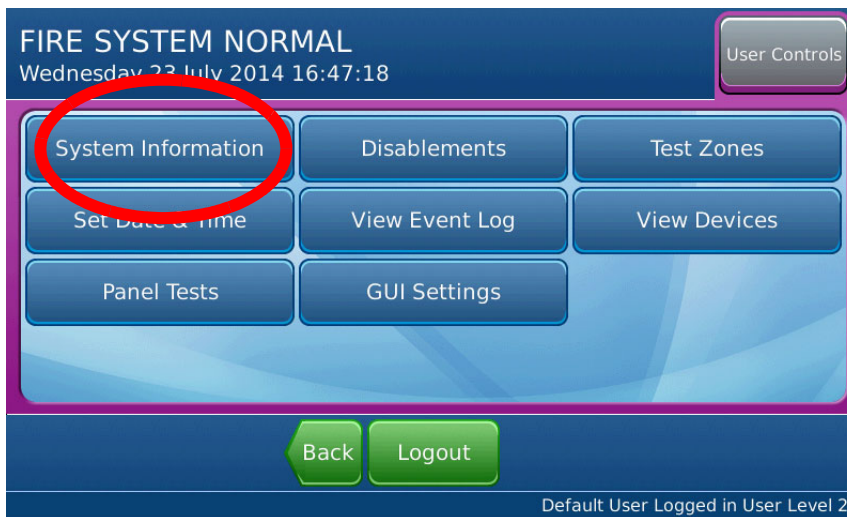

- 3 The System Information window is displayed:

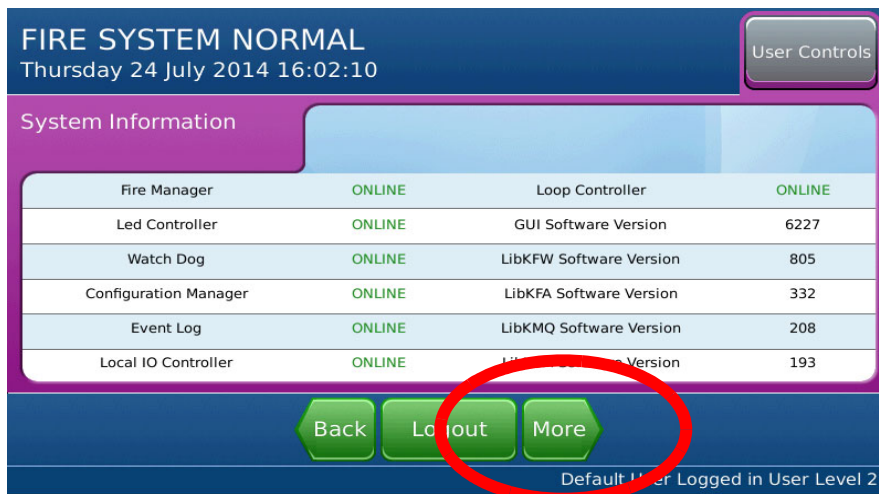

The image provided is an example rendering of a System Information window.

4 Press More to display a third System Information window

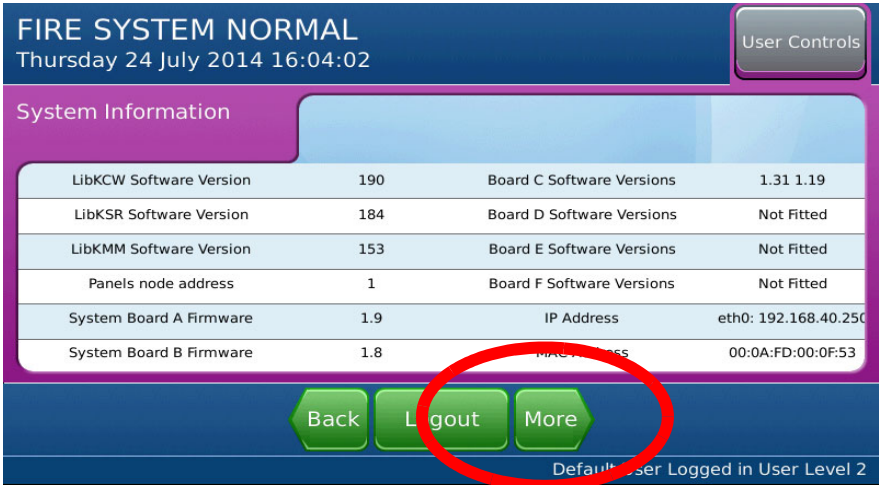

The System Information window is displayed:

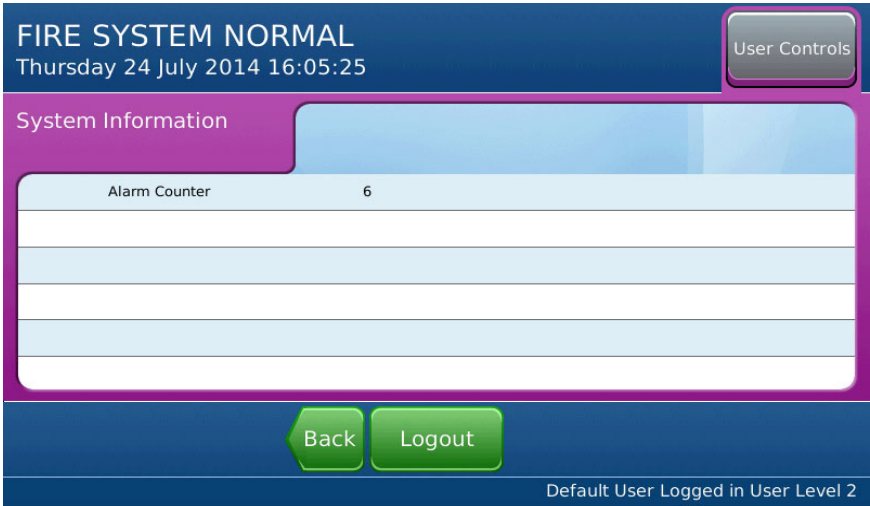

Event Log

View the Event Log to determine status of initiating devices, signaling line circuits and notification appliances.

To view the Event Log of the FACP:

- 1 Press the Fire System Normal screen to open the User Controls window.
- 2 Press View Event Log on the User Controls window:

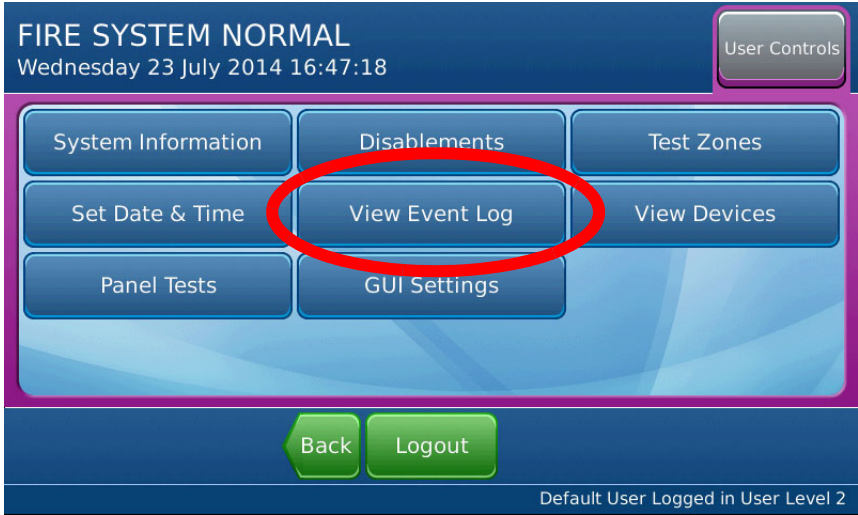

- 3 Press More Details to display additional information about the posted event-message:

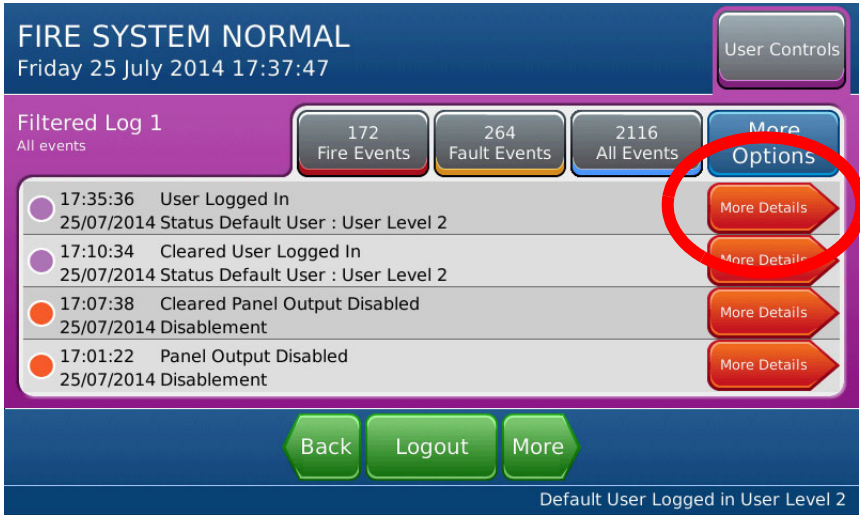

The image provided is an example rendering of the View Event Log.

Section 4

Panel Maintenance

This section describes:

- Maintaining the FACP (Fire Alarm Control Panel).

Maintenance

Perform the following procedures to maintain operation of the FACP.

Cleaning the Touch Screen Display

The touch screen display is made of fragile materials. Do not apply excessive force to the display surface since this may cause damage.

A polariser covering the display surface is soft and easily scratched therefore do not operate the display with items harder than, for example a blunt HB pencil.

If the display is damaged causing liquid crystal substance to leak, any contact with skin or clothes, wash thoroughly with soap and water.

If the display surface becomes dirty gently wipe with a soft dry cloth.

If the display is heavily contaminated, moisten the cloth and gently clean using one of the following solvents:

- Isopropyl alcohol
- Ethyl alcohol

Do not use:

- Water
- Ketone
- Bleach
- Cream cleaners
- Polish
- Detergents or general-purpose surface spray

Important! Wipe off water droplets immediately, contact with water over a prolonged period may cause deformation or colour fading. Avoid any contact with oil and fats.

Cleaning the Control Panel Enclosure

Gently clean using a soft dry cloth to remove any dust or dirt.

If the enclosure is heavily contaminated, moisten the cloth and gently clean using a light detergent.

Important! Avoid getting detergent on controls section of the Control Panel.

Inspecting Batteries

Inspect the Standby-batteries annually to determine the connection integrity to the power supply and to confirm the voltage capacity available for operating the FACP during power failures.

Replacing Standby-Batteries

Replace both standby-batteries when required either through testing or as local codes of practice dictate. Batteries to be replaced with the types specified in this manual and sized according to local codes of practice for the standby period required.

Removing the Standby-Batteries

Before removal of batteries the panel should have all external power removed and adequate safety precautions should be put in place so that the battery terminals cannot be shorted.

To remove the existing standby-batteries:

- 1 Disconnect the jumper-cable connection between batteries.
- 2 Disconnect the red-cable from the positive Terminal of either battery.
- 3 Disconnect the black-cable from the negative Terminal of either battery.
- 4 Remove both batteries from the bottom of the FACP cabinet.
- 5 Dispose of both batteries according to local bylaws or recycling regulations.

Installing the Standby-Batteries

To install the replacement standby-batteries:

- 1 Place both standby-batteries at the bottom of the FACP cabinet.
- 2 Connect the black-cable to the negative terminal of one battery.
- 3 Connect the red-cable to the positive terminal to the other battery.
- 4 Connect the jumper-cable from the unused negative terminal one battery to the unused positive terminal of the other battery.
- 5 Mark a "placed into service date" on both Batteries.

Reconnect power and ensure that the system is fully operational.

The figure below illustrates connections for installing standby-batteries in the base of the FACP:

Figure 4-1
Installing Standby-Batteries

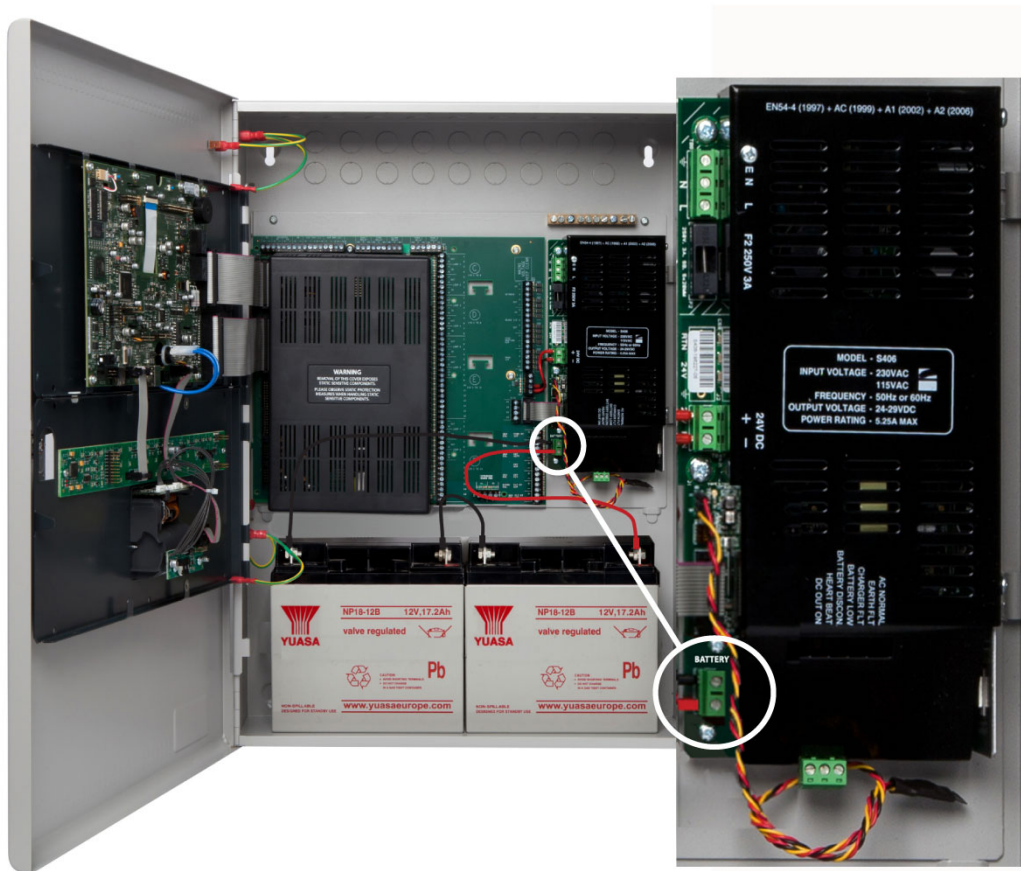

The series connection illustrated above provides the 24 volt standby voltage required by the Fire Control Panel. Do not connect the two batteries in parallel. A parallel connection will not provide the 24 volts required for operating the FACP in a standby condition.

Replacing Fuses

the FACP contains a power-supply-fuse for protection against line overloads.

Replace a fuse only after replacing components responsible for causing the fuse failure. 3 Amp Power-Supply Fuse.

Replace the 3 Amp Power-Supply Fuse by removing it from the fuse-housing contained on the circuit board of the power supply. Install the replacement fuse in the fuse-housing and then test the power supply to determine that it operates.

The figure below illustrates the 3 Amp fuse of the 5.25A power supply:

Figure 4-2
3 Amp Power Supply Fuse



Removing the Fuse

To remove the fuse:

- 1 Turn off the main breaker that feeds AC power to the FACP.

WARNING!



This is a high voltage circuit area. An electrical shock hazard exists in this area when the control panel is operating. Do not remove the fuse while powering the FACP. Remove AC power at the source before attempting to remove the fuse of the power supply.

- 2 Locate the housing containing the 3 Amp fuse for 5.25A PSU and 5Amp fuse for 10.25A PSU. Refer to Figure 3-2.
- 3 Remove the upper-half of the fuse-housing with long-nose-pliers.
- 4 Remove the fuse from the upper-half of the fuse-housing.

The figure below illustrates the open fuse-housing, note this is the same for both 5.25A and 10.25A PSU's:

Figure 4-3
Open Fuse Housing

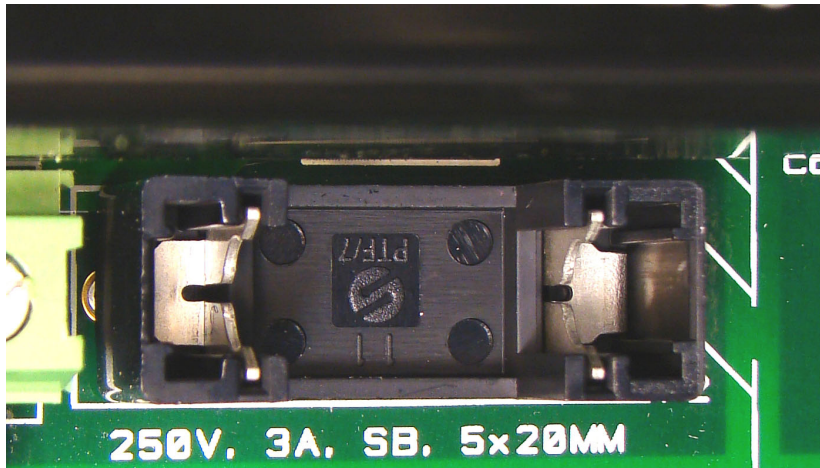

Replacement fuses must match the types originally fitted on the FACP.

Care must be taken to select the correct one when fitting replacements.

Installing the Replacement Fuse

To install the replacement fuse:

- 1 Ensure that the main breaker that feeds AC power to the FACP is still disconnected.

WARNING!



This is a high voltage circuit area. An electrical shock hazard exists in this area when the control panel is operating. Do not install the fuse while powering the FACP. Remove AC power at the source before attempting to install the 3 Amp fuse of the power supply.

- 2 Insert the fuse in the upper-housing.
- 3 Center the position of the fuse in the upper-housing.
- 4 Press the upper-housing on the lower-housing until the halves snap together.

The figure below illustrates the closed fuse-housing:

Figure 4-4
Closed Fuse Housing

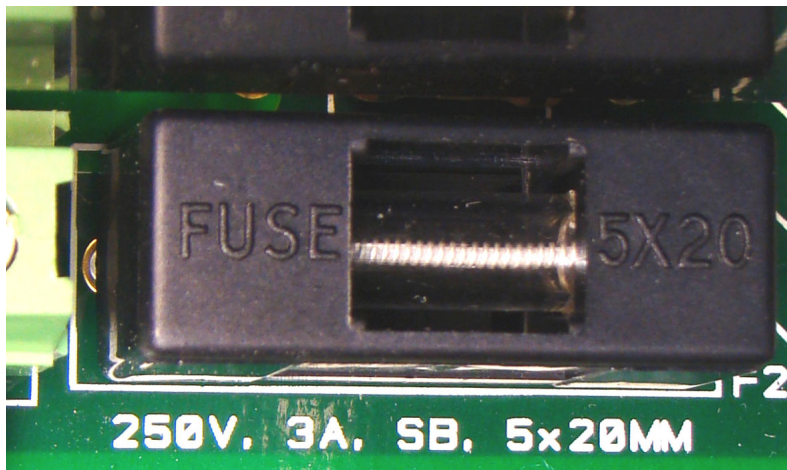

- 5 Restore AC power to the power supply of the FACP.
- 6 Monitor the touch-panel-display and LED indicators on the fascia of the FACP to determine that fault conditions are not reported following replacement of the fuse.

Replacing Internal Components

It may be necessary to remove and replace internal components during the operating life of the FACP. The following procedure describes removing the Fascia, Lid, Chassis and Batteries of the FACP. The Fascia contains the LCD Main Processor Board and Zone LED indicators of the FACP. The Chassis contains the Main Back Board, the 5.25 Amp or 10.25 Amp Power Supply and grounding terminals.

WARNING!



This is a high voltage circuit area. An electrical shock hazard exists in this area when the control panel is operating. Do not open the Fire Control Cabinet whilst power is still applied to the FACP. Remove AC power at the source before attempting to replace any internal components.

For 16 Loop versions of the FACP negate stages 3, 6 & 8. Fascia panel is adjoined to cabinet door.

To remove and replace these internal components of the FACP:

- 1 Turn the key clockwise to unlock and open the cabinet-door of the FACP.

Figure 4-5
Unlocking and Opening the Cabinet-Door



- 2 Grasp the metal assembly at both ends shown by the arrows and then tug gently to open the fascia of the FACP.

Figure 4-6
Opening the Fascia



- 3 Open the fascia of the FACP by pulling gently at the locations marked by the arrows in the illustration above.
- 4 Disconnect four earthing-jumper cables from the lid and leave the opposite cable ends connected for safekeeping.

Figure 4-7
Removing Earth Bonding connections

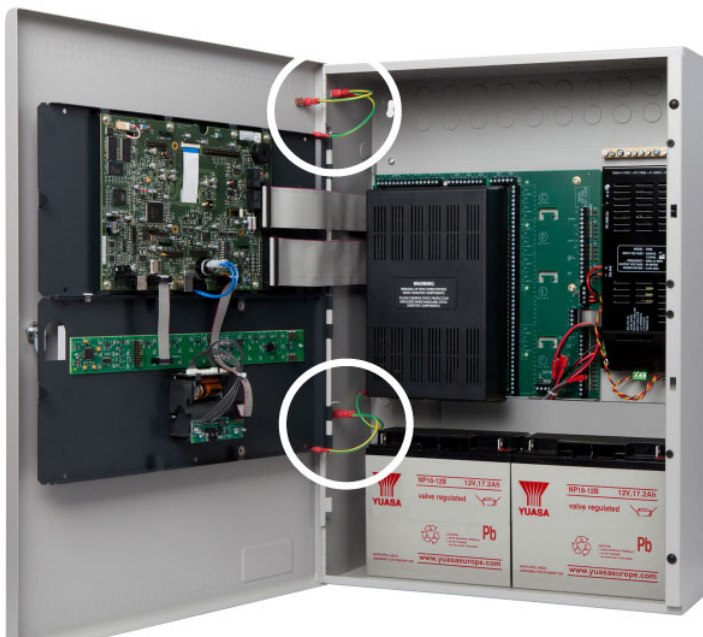

- 5 Remove the ribbon cables shown from the LCD Main Processor Board.
The cables can be reconnected to the LCD Main Processor Board during the re-assembly process.

Figure 4-8
Removing Ribbon Cables

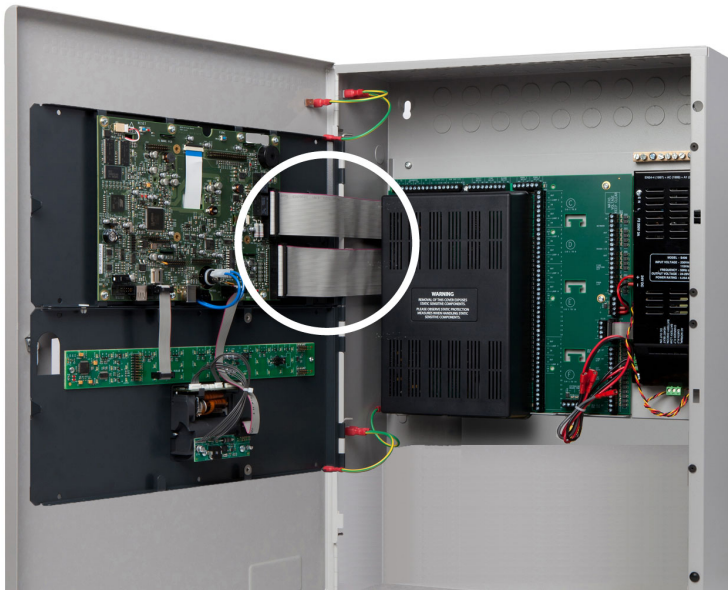

- 6** Remove four hinge-pins of the Fascia and then remove the Fascia from the Cabinet-Box of the FACP.
Return the four hinge-pins to the hinges of the Cabinet-Box for safekeeping.

Figure 4-9
Removing Hinge-Pins of the Fascia

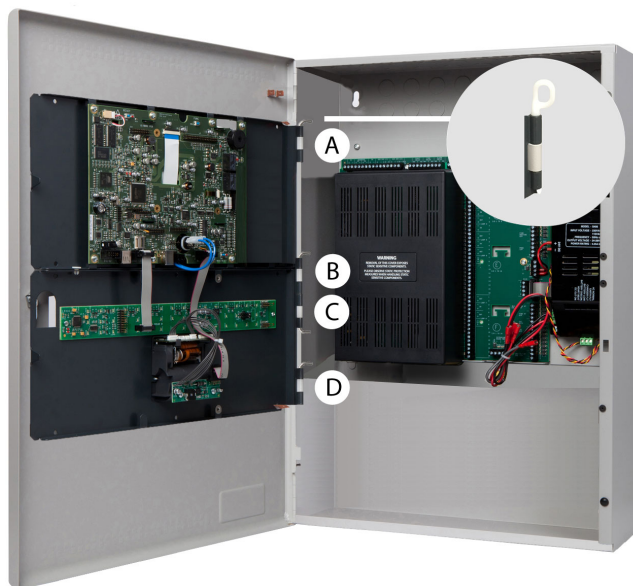

To remove the Fascia from the Cabinet-Box:

- 1** Pull the head of the upper-hinge-pin (A) away from the hinge-assembly using finger in hinge hoop.
- 2** Brace the top-corner of the Cabinet-Lid to maintain alignment with the lower-hinge.
- 3** Pull the head of the lower-hinge-pins (B), (C) and (D) away from the hinge-assembly using finger in hinge hoop.
- 4** Remove the Fascia from the Cabinet-box of the FACP when the four hinge-pins have been removed.

- 7 Remove two hinge-pins of the Cabinet-Lid and then remove the Cabinet-Lid from the Cabinet-Box of the FACP.
Return the two hinge-pins to the hinges of the Cabinet-Box for safekeeping.

Figure 4-10
Removing the Hinge-Pins of the Cabinet-Lid

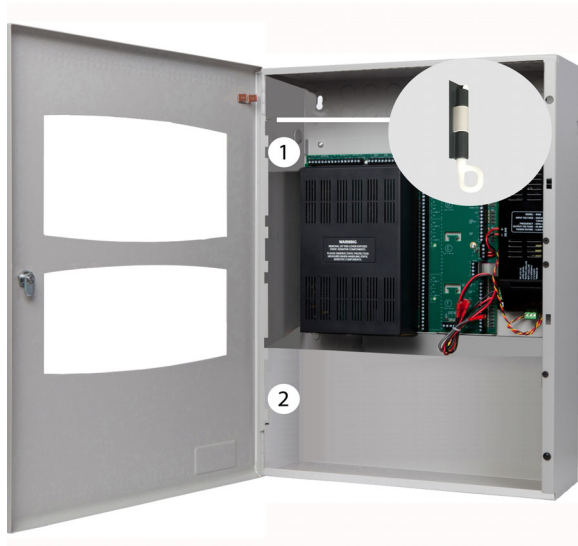

To remove the Chassis from the Cabinet-Box:
To remove the Cabinet-Lid from the Cabinet-Box:

- 1 Remove three Posi-head mounting-screws (A) from the top portion of the Chassis.
Pull the head of the upper-hinge-pin (1) away from the hinge-assembly using finger in hinge hoop and push bottom across to release.
- 2 Slide the Chassis upward to remove it from tabs (B) of the Cabinet-Box.
Brace the top-corner of the cabinet-door to maintain alignment with the lower-hinge.
- 3 Place the three Posi-head mounting-screws in the holes of the Cabinet-Box for re-attaching the Chassis.
Pull the head of the lower-hinge-pin (2) away from the hinge-assembly using finger in hinge hoop and push bottom across to release.
- 4 Remove the Cabinet-Lid from the Cabinet-box of the FACP when the two hinge-pins have been removed.

- 8 Removing Back plate
Replace the retaining-screws for safekeeping.

Figure 4-11
Removing the ChassisChassis

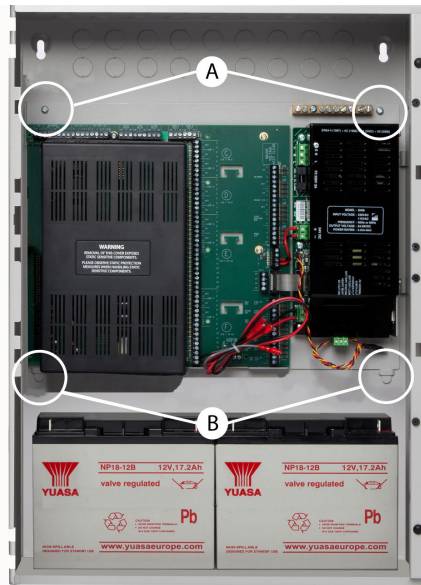

To remove the Chassis from the Cabinet-Box:

- 1 Remove two Phillips-head mounting-screws (A) from the top portion of the Chassis.
- 2 Slide the Chassis upward to remove it from tabs (B) of the Cabinet-Box.
- 3 Place the two Phillips-head mounting-screws in the holes of the Cabinet-Box for re-attaching the Chassis.

- 9 **Figure 4-12**
Removing the Chassis
For 2 to 16 Loop versions on the FACP Only.



Internal Component Connections 2 to 8 loop

Figure 4-13
Overview of Internal Component Connections

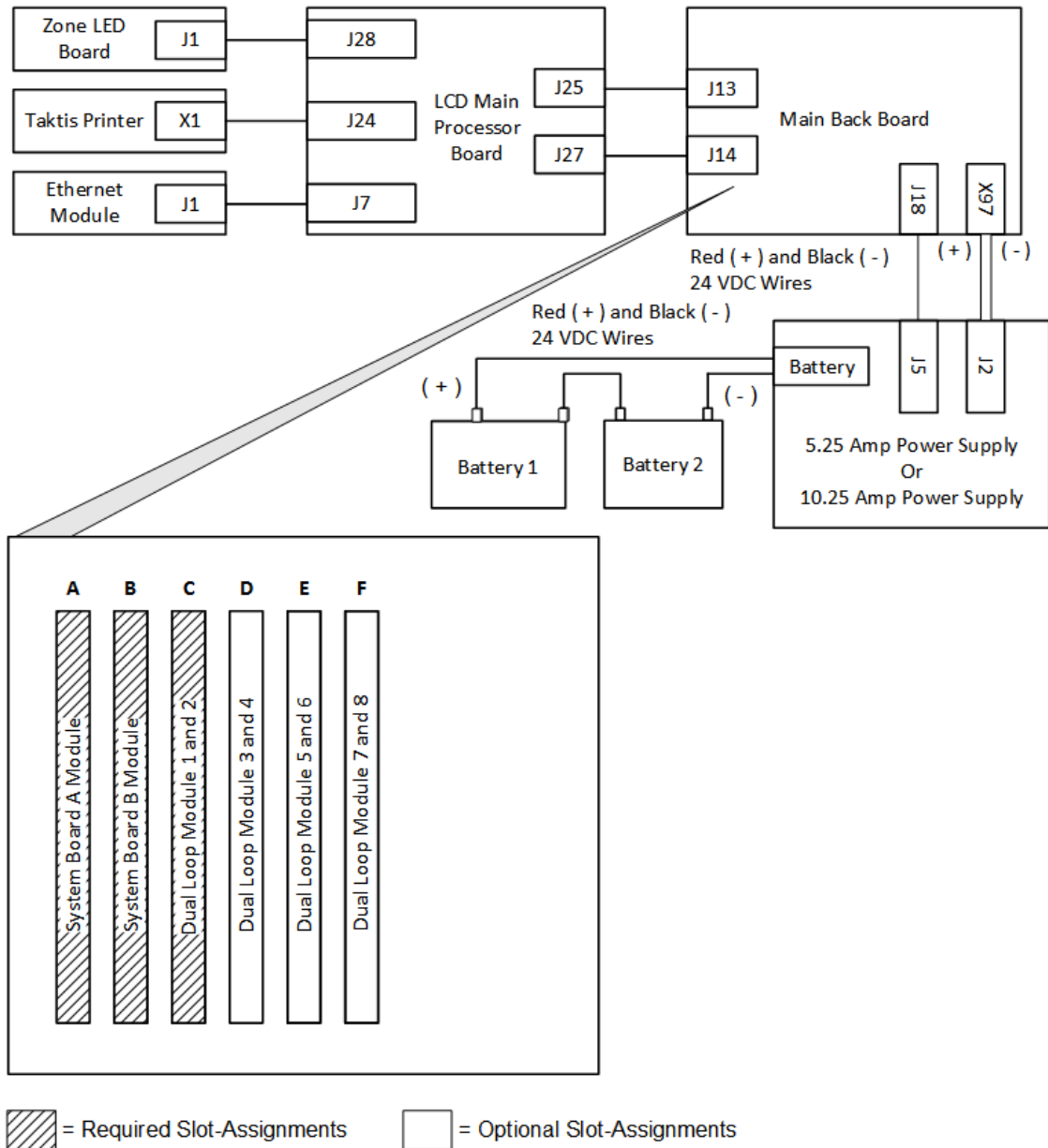

Internal Component Connections 2 to16 loop

The figure below shows internal Component Connections for 2 to16 loop versions of the panel where the Extension Board is fitted.

Figure 4-14
Internal Component Connections to Extension Board

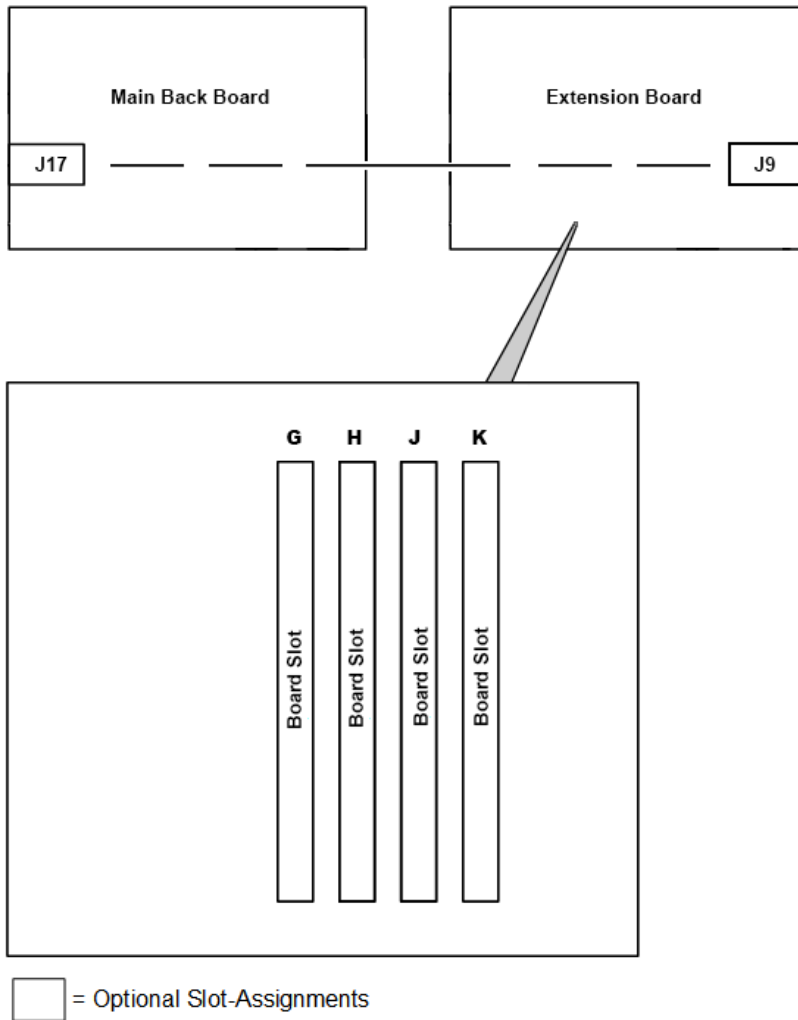

Appendix A

Specifications

This appendix provides electrical and environmental specifications for the FACP (Fire Alarm Control Panel). Current levels provided in the tables of this appendix are maximum ratings unless otherwise indicated.

Electrical**AC Line Ratings**

Terminal	Description	Voltage	Power
L	AC line	115 VAC, 50/60 Hz, 24 VDC @ 5.25A	264 VA
		115 VAC, 50/60 Hz, 24 VDC @ 10.25A	275 VA
		230 VAC, 50/60 Hz, 24 VDC @ 5.25A	264 VA
		230 VAC, 50/60 Hz, 24 VDC @ 10.25A	275 VA
N	AC neutral		
E	Earth ground		

Power Supply

Power Supply specifications pertain to terminations of standby-batteries at battery connections of the 5.25 Amp or 10.25 Amp power supply.

Power Supply Fuses

Parameter	Description
115 VAC, 24 VDC @ 5.25A	3A, 250 VAC, Slow-blow, 5 x 20 mm
115 VAC, 24 VDC @ 10.25A	5A, 250 VAC, Slow-blow, 5 x 20 mm
230 VAC, 24 VDC @ 5.25A	3A, 250 VAC, Slow-blow, 5 x 20 mm
230 VAC, 24 VDC @ 10.25A	5A, 250 VAC, Slow-blow, 5 x 20 mm

Power Supply Input / Output Ratings

Parameter	Description
Output Voltage	24 VDC
Output Current	24 VDC @ 5.25 A or 10.25 A
Battery Capacity	Maximum Amp-hour capacity for 5.25 Amp and 10.25 Amp Power Supplies
5.25 A	26 Ah maximum
10.25 A	45 Ah maximum (Subject to enclosure space)
Load output voltage	19V DC minimum, 30V DC maximum
Load output current	5.25A maximum or 10.25A maximum
Ripple Voltage	1V maximum
I _{max a}	Rated maximum output current which can be supplied continuously for the 5.25 Amp and 10.25 A Power Supply.
5.25A	3.3A
10.25A	7.3A
I _{max b}	Rated maximum output current which can be supplied while battery charging is not required on the 5.25A and 10.25A Power Supply.
5.25A	4.5 A
10.25A	9.5 A
I _{min}	10mA, minimum output current for correct operation
RI Max.	Maximum series resistance in battery charging circuit before a fault is indicated
5.25A	1 Ohm
10.25A	0.4 Ohm

Earth Fault Indication

An earth fault indication occurs on the FACP when a minimum of 30K Ohms exists between earth-ground and either DC RTN or +24 VDC of the power-supply.

System Power

Standby and alarm conditions of the FACP are expressed in volt-amperes VA at the primary of the power supply. Secondary standby and alarm currents of the power supply are determined under no load conditions and occur during AC power failure at the primary. The resulting no-load current draw from the 5.25 Amp or 10.25 Amp Power Supply occurs from standby-battery operation on the secondary. All loads of the FACP exclude external loads except End Of Line (EOL) devices. "Primary" loads of the FACP assume a fully charged battery. Alarm currents are dependent on the number of active zones and the number of active Audio / Visual devices.

Standby and Alarm Current

Standby and Alarm Currents are provided below for 115 VAC and 230 VAC models of the 5.25A and 10.25A Power Supply. The data includes current of the fire alarm control panel in 2 and 4 loop conditions.

Two loop operation includes System Board A Module, System Board B Module and the Dual Loop Module.

Four loop operation includes the System Board A Module, System Board B Module and two Dual Loop Modules.

Two loop operation represents the minimum board configuration of the FACP.

5.25 A, 115 VAC Power Supply

Loops	Standby (mA)	Alarm (mA)	Description
2	244mA @ 115 VAC	272mA @ 115 VAC	Line current for standby and alarm when battery current is less than 30mA.
	560mA @ 24 VDC	650mA @ 24 VDC	Battery current for standby and alarm when power failure condition occurs on the AC line.
4	274mA @ 115 VAC	302mA @ 115 VAC	Line current for standby and alarm when battery current is less than 30mA.
	680mA @ 24 VDC	760mA @ 24 VDC	Battery current for standby and alarm when power failure condition occurs on the AC line.

5.25 A, 230 VAC Power Supply

Loops	Standby (mA)	Alarm (mA)	Description
2	162mA @ 230 VAC	177mA @ 230 VAC	Line current for standby and alarm when battery current is less than 30mA.
	560mA @ 24 VDC	650mA @ 24 VDC	Battery current for standby and alarm when power failure condition occurs on the AC line.
4	174mA @ 230 VAC	190mA @ 230 VAC	Line current for standby and alarm when battery current is less than 30mA.
	680mA @ 24 VDC	760mA @ 24 VDC	Battery current for standby and alarm when power failure condition occurs on the AC line.

10.25 A Power Supply, Universal Input Voltage

Loops	Standby (mA)	Alarm (mA)	Description
2	220mA @ 115 VAC 176mA @ 230 VAC	234mA @ 115 VAC 181mA @ 230 VAC	Line current for standby and alarm when battery current is less than 30mA.
	550mA @ 24 VDC	620mA @ 24 VDC	Battery current for standby and alarm when power failure condition occurs on the AC line.
4	228mA @ 115 VAC 180mA @ 230 VAC	242mA @ 115 VAC 185mA @ 230 VAC	Line current for standby and alarm when battery current is less than 30mA
	660mA @ 24 VDC	750mA @ 24 VDC	Battery current for standby and alarm when power failure condition occurs on the AC line.

The data provided above for standby and alarm current includes loads of the FACP alone and excludes current loads from external devices or equipment.

The universal input voltage of the 10.25 A Power Supply is described with inputs of 115 VAC and 230 VAC.

Rechargeable Standby-Battery Circuit

Parameter	Description
Standby-Battery Type	Two 12 VDC, rechargeable, valve-regulated, lead-acid. Specify standby-battery manufacturers from Yuasa NP or Powersonic.
Standby-Battery Capacity	<i>Reference Appendix to determine the Amp-hour rating of the standby-batteries.</i>
Charge Current	Maximum charge current of Standby-Batteries when operating 5.25 Amp or 10.25 Amp Power Supplies.
5.25 Amp Power Supply	1.25A maximum
10.25 Amp Power Supply	2.25A maximum
Battery Quiescent Current	80mA in mains failure
Standby-Battery Charging	Two standby batteries wired in series
Battery Charging Voltage	26.4 V DC at 40 ⁰ C to 28.9 V DC at -5 ⁰ C
Battery Disconnect	Low battery shutoff voltage, 19 +/- 1V DC
Standby-Battery Charge Voltage	27.6 V nominal, temperature compensated and current limited
Current Draw of Standby-Battery In mains Fail, Standby, Not in Alarm	Greater than 200mA with buzzer sounding
Maximum Current Draw of the FACP In Alarm	Greater than 200mA, the current does not include loads from sounders, solenoid, status units, ancillary boards or auxiliary equipment
Current Draw of Standby-Batteries When main is Disconnected While Operating the Internal Power Supply	
5.25 Amp Power Supply	5.5A maximum
10.25 Amp Power Supply	11A maximum

Standby-Battery Loads

Standby-battery loads are generated by measuring the series battery current of the power supply following a mains fail condition.

Standby and alarm current of the FACP can include all or part of the following loads:

:

Loads	Standby Current	Alarm Current
the FACP, 5.25 A Power Supply	78mA	78mA
the FACP, 10.25 A Power Supply	50mA	50mA
System Board A Module	20mA	20mA
System Board B Module	25mA	25mA
Dual Loop Module	80mA	80mA
Sounder Outputs	0mA (per sounder output)	2.5A (per sounder output)
LCD main Processor Board *	195mA	270mA
Zone LED Board	5mA	3mA per LED
Network, Ethernet & IFAM Interface Module	59mA	59mA
Printer	25mA	25mA

* The display of the LCD main Processor Board is dimmed.

Loop Cabling

Cable maximum parameters:

Parameter	Description
Resistance	100 ohms total for both cores
Core to Core Capacitance	300nF
Core to Screen Capacitance	450nF
Inductance Per Core	600uH

Approved Cable

Standard 30 Minute Fire Rated Cables	Available Core Sizes		
Firecel SR/114H	1.0mm ²	1.5mm ²	
Draka Firetuf FT30	1.0mm ²	1.5mm ²	
IDH Kilflam 2000	1.0mm ²	1.5mm ²	2.5mm ²
Pirelli/Prysmian FP200 Gold	1.0mm ²	1.5mm ²	2.5mm ²
Tyco thermal Control Pyro-S	1.0mm ²	1.5mm ²	2.5mm ²
Enhanced 120 Minute Fire Rated Cables	Available Core Sizes		
Firecel SR/114E	1.0mm ²	1.5mm ²	2.5mm ²
Draka Firetuf PLUS	1.0mm ²	1.5mm ²	2.5mm ²
IDH Kilflam 3000	1.0mm ²	1.5mm ²	2.5mm ²
Pirelli/Prysmian FP PLUS	1.0mm ²	1.5mm ²	2.5mm ²
Wrexham Mineral Insulated Cables	1.0mm ²	1.5mm ²	2.5mm ²

Serial Data and Terminal Capacity

Parameter	Description
Serial Data Connection	2 core RS485 (Up to 1150 metres total cable length)
Maximum Terminal Capacity	2.5mm ²

Detection Loop Ratings

Parameter	Rating
LOOP 1 (- OUT), (+ OUT) LOOP 1 (- IN), (+ IN)	36 VDC @500mA
LOOP 2 (- OUT), (+ OUT) LOOP 2 (- IN), (+ IN)	36 VDC @500mA

Sounder Output

Individual and combined sounder outputs are load dependent and are limited to a maximum current load of 2.5A:

Terminal	Connection	Rating
(+), (-)	S1, S2, S3, S4	24 VDC @ 2.5A, programmable for continuous power, synchronisation and power-drop on reset. Fused: Electronic, programmable fuse current level Supervision: Voltage reversing DC Short Circuit Threshold: 130 Ohms +/- 20% Maximum line-voltage-drop: 2V DC
		End Of Line Diodes (EOLD)

AUX 24V (1) and (2)

Terminal	Rating
(+), (-)	24 VDC @ 1A

The 24 V (1) and 24 V (2) connection is a common output and provides a 24 VDC output.

Relay Ratings

Terminals	Connection	Ratings
(NO), (C) and (NC)	FAULT RELAY FIRE RELAY ALARM RELAY PROG 1 PROG 2	Power Factor: 1.0 Relay Function: Common, Programmable, Not monitored 30 VDC @ 1A maximum, Volt free change over contact

Network RS485 I/O

Terminal	Rating
E , Earth Ground	0 V
(+), (-) IN	(+) Data 3.3 VDC @42mA
(+), (-) OUT	(+) Data 3.3 VDC @42mA
Specification	Data
Number of devices supported on the network	128

The RS485 I/O provides standard RS485 in single-drop mode with 120 Ohm terminations.

Fire Routing Serial I/O

Terminal	Rating
E, Ground Earth	0 V
(+), (-)	Data 3.3 VDC @ 42mA

The Fire Routing I/O is programmable.

Fire Routing O/P

Terminal	Rating
(+), (-)	24V DC @ 100mA
	10K End Of Line Resistor (EOLR)
	Self Resetting Fuse rated 500mA

The monitored output of the Fire Routing O/P is reverse polarity.

Fault Routing O/P

Terminal	Rating
(+), (-)	24V DC @ 100mA
	10K End Of Line Resistor (EOLR)

Prog I/P 1, 2 and 3

Terminals	Rating
1, 2, 3, to 0V	Unsupervised Input: <ul style="list-style-type: none"> • Open circuit voltage: 24 VDC. • Short Circuit current: 3.3mA • Threshold Impedance: 2 K Ohms

System Components

Parameter	Description
Software Zones	2000 zone capacity
Software Groups	500 group capacity
Event Log	10,000 event capacity, 1 second resolution. Filterable and printable.
Detection Loops	Up to 16 loops (defendant on model) added 2 at a time (K758 Dual Loop Modules)
Relays	Fault, Fire, Alarm, programmable 1 and programmable 2 are programmable, Volt free changeover relay contacts rated at 30 Volts DC at 1 Amp are provided for ancillary switching function
Inputs and Outputs	
Programmable Inputs	3 inputs activated by volt free contacts
Auxiliary Serial Port A	RS232 programmable
Auxiliary Serial Port B	RS232 programmable
Ancillary I/O board Serial Port	RS232 programmable
Fire Routing (IFAM) Serial Port	RS232 programmable
Parameter	Description
USB Host Port	USB Type A
USB Device Port	USB type B

Fire Routing Output	Monitored
Fire Routing Input	Monitored
Fault Routing Output	Monitored
Fault Routing Input	Monitored
Parameter	Description
Extinguisher Output	Monitored
Extinguisher Input	Monitored
Extinguisher Fault Input	Monitored

Mechanical

Cabinet Components

Components	Description
Display	Full colour 800 x 480 LCD with resistive touch screen and automatic backlight dimming
Printer	40 column, front loading thermal (optional)
Zone LED Indicators	Up to 3 banks of 48 (144)

Cabinet Housing

Housing	Description
Dimensions	
2 to 8 loop Standard Cabinet	420mm (W) x 590mm (H) x 150mm (D)
2 to 8 loop Deep Cabinet	420mm (W) x 590mm (H) x 194mm (D)
2 to16 loop Standard Cabinet	540mm (W) x 720mm (H) x 150mm (D)
2 to16 loop Deep Cabinet	540mm (W) x 720mm (H) x 205mm (D)

Housing	Description
Construction	
2 to 8 loop Standard and Deep Cabinet Models	<p>These models include:</p> <ul style="list-style-type: none"> • Mild sheet steel enclosure, 1.5 mm • Removable equipment chassis • All epoxy powder coated • Knockouts top and back, one on each side • Hinged lid with single lock • Hinged bridge plates containing fascia indications • Optional printer
Construction	
2 to16 loop Standard and Deep Cabinet Models	<p>These models include:</p> <ul style="list-style-type: none"> • Mild sheet steel enclosure, 1.5 mm • Removable equipment chassis • All epoxy powder coated • Knockouts top and back, two on each side • Hinged lid with single lock • Lid mounted fascia indications • Optional printer

Housing	Description
Finish	Epoxy powder coated
Colour	
Lid & Box	BS 00 A 05 fine texture
Controls Plate	RAL7016
Cable Entry	
2 to 8 loop Standard and Deep Cabinet Models	20 mm knockouts, 28 on top, 18 on back, 1 on each side
2 to16 loop Standard and Deep Cabinet Models	20mm knockouts, 35 on top, 12 on back, 2 on each side 28mm knockouts, 3 on top, 3 on back
Mounting fixings	5mm thread diameter, minimum 40mm length
IP Rating	IP30
Weight	
2 to 8 loop Models	14-16Kg
2 to16 loop Models	20-22Kg

Operating Environment

Parameter	Temperature	Description
Low Temperature	-5°C	Dry indoor use only
High Temperature	40°C	Dry indoor use only

Required Circuit Boards

System Board A Module

System Board A Module provides essential functions on the FACP.

These functions include:

Parameter	Description
Sounders 1 to 4	An EOL diode is required per sounder. Default, Spur circuit, 2.5A trip after 50 ms and fixed constant current limit of 3.3A.
Sounder 1 and 2	Loop or 2x Spur
Sounder 3 and 4	Loop or 2x Spur
J18 PSU monitor	Battery disconnected, mains fail, battery low, PSU earth fault, charger fault.
Power fail input	A connection of less than 2K to 0V will indicate a power fail
Earth fault	A connection of 100K or less between a back board terminal (except volt free terminals) and earth will be indicated by an earth fault.

System Board B ModuleFACP

System Board B Module monitors and controls essential input and output functions on the FACP.

The System Board B Module includes the following functions::

Parameter	Description
AUX 24 Output 1	24VDC supply rated at 1 Amp
AUX 24 Output 2	24VDC supply rated at 1 Amp
Fire Routing Output	0V output switches to 24V, fused at 100mA, requires End Of Line (EOL) diode
Fault Routing Output	24V output switches to 0V, fused at 100mA, requires 3K3 EOL resistor.
Fire Routing Input	Monitored input, requires 3K3 EOL resistor
Fault Routing Input	Monitored input, requires 3K3 EOL resistor
Parameter	Description
Extinguishing Output (EXT O/P)	Passive output, 3K3 resistor, 680R resistor when active
Extinguishing Input Activated (EXT ACTV)	Monitored input, 3K3 end of line resistor
Extinguishing Fault Input (EXT FAULT)	Monitored input, 3K3 end of line resistor
Fire Relay	Volt free contact rated at 30V, 1A

Fault Relay	Volt free contact rated at 30V, 1A
Alarm Relay	Volt free contact rated at 30V, 1A
Programmable Relay 1 (PROG	Volt free contact rated at 30V, 1A
Programmable Relay 2	Volt free contact rated at 30V, 1A

Abbreviated function descriptions of the Back Board and the System Board B Module are provided in parentheses in the table above.

Supplementary Devices

Vision Unit

Electrical

Parameter	Description
Mains supply (Mains powered models only)	230V AC +10% - 15% (20 Watts maximum)
Mains supply fuse (Mains powered models only)	2 A, 20mm, glass HRC
Power supply rating (Mains powered models only)	0.75A total including battery charge 28V +/- 2V
Maximum ripple current (Mains powered models only)	200mV
Battery type (Yuasa NP) (Mains powered models only)	Two 12 Volt 1.9 Ah sealed lead acid in series
Battery charge voltage (Mains powered models only)	27.6 VDC nominal
Battery charge current (Mains powered models only)	0.2A maximum
Battery fuse (Mains powered models only)	200mA, 20mm, glass
Maximum current draw from batteries (Mains powered models only)	0.095A
24V supply (24V DC models only)	21 to 30 VDC
Quiescent current of panel in mains fail	0.03A
Maximum number of units to be powered from the Aux 24V output	Maximum limited by Aux 24V capacity

Communication

Parameter	Description
Max number of units on the RS485 network	127 repeaters

Mechanical

Parameter	Description
Size	235 mm x 170 mm x 55 mm
Display	Full colour 800 x 480 LCD with resistive touch screen and automatic back-light dimming
Construction	18 SWG, 1.2 mm mild sheet steel, IP30 rated
Cable Entry	2 x 20 mm knockouts on top & bottom 3 x 20 mm and 2 x 28 mm knockouts in back
Finish	Epoxy powder coated
Colour	Lid & Box, BS 00 A 05 fine texture
Weight	2 Kg maximum
IP Rating	IP30

Appendix B

Calculations

This section describes current-loading determining the total load current and selecting standby batteries.

Current-Loading

Current-loading of the FACP (Fire Alarm Control Panel) FACP is limited to the capacity of the 5.25 Amp or 10.25 Amp power supplies. the FACP installers must determine the loading placed on these power supplies by adding the sum of device-loads to the no-load-alarm current of the FACP. The result obtained from this calculation must be below the operating current of the 5.25 Amp and 10.25 Amp Power Supply.

The 5.25 Amp power supply operates the FACP and external loads with 4 Amps and reserves 1.25 Amps for charging the standby-batteries. The 10.25 Amp power supply operates the FACP and external loads with 8 Amps and reserves 2.25 Amps for charging the standby-batteries.

The calculation of total-current-loading must include the sum of device-loads on the circuit outputs of the FACP. Circuits to be included in this calculation for total-current-loading are:

- Panel standby and alarm currents
- Detection loops
- Sounder outputs
- 24V OUT
- AUX 24V
- Peripheral interface cards
- Network cards
- Remote 10.25A power supply (where applicable)
- External third party (where applicable)

The current limits provided in the Appendix "Specifications" are maximums for each of the circuit-connections on the FACP. These levels are not intended to be summed together to determine the total-current available from the FACP. Refer to these levels only when determining the limit of device-loading on each circuit.

Determining the Total Load Current

The following *example* demonstrates the process for determining the total load-current of the FACP with the 5.25A or 10.25A Power Supply:

- 1 Identify the current consumption of each device on the circuit-connection.
- 2 Add the device-currents together in each circuit-connection.
- 3 Compare the sum of the device-currents with the current-limit of each circuit-connection to verify that the summed level is below the current-limit value.
- 4 Add the device-load-currents together that were obtained for each of the circuit-connections:

Circuit-Connection	Maximum Current Limit	Example Load Current
Detection Loop 1	500mA	150mA
Detection Loop 2	500mA	50mA
AUX 24V	1A	0
Sounder 1	2.5A	750mA continuous DC
Sounder 2	2.5A	925mA continuous DC
Total Device Load		1.875A

- 5 Add the Total Device Load to the no-load-alarm current of the FACP to obtain the FACP Total-Load-Current.

Total Device Load + FACP (No-Load) = Total-Load-Current

$$1.875 \quad + \quad 200\text{mA} \quad = \quad 2.075\text{A}$$

Total Load Current: **2.075A**

- 6 Verify that the current level is below 5.25 Amps: **2.075A < 5.25A**

This example demonstrates that device-loading *does not exceed* the 5.25A capacity of the power supply.

Reference "Specifications" for the maximum current limits provided in the example calculation above.

Selecting Standby Batteries

The following tables provide information for selecting standby batteries, power supply and enclosure(s) type depending on system configuration, number of loops and standby period required. When selecting batteries the values shown are minimum and the nearest capacity batteries, shown the Appendix “Compatible Standby Batteries” section should be used.

All batteries are to be paired, wired in series (for 24V) using the battery jumper leads supplied.

These are for guidance only and the required capacity should be calculated from the measured figures during commissioning.

PANEL ONLY - Stand alone panel (no loop load, no network card)			
24 Hours Standby			
Loops	Min. Battery Capacity (Ah)	Power Supply (table 1)	Enclosure (table 2)
2	12.1	5.25A	Standard/Deep
4	14.5	5.25A	Standard/Deep
6	16.7	5.25A	Standard/Deep
8	19.5	5.25A	Standard/Deep
10	21.1	5.25A	Standard/Deep
12	23.0	5.25A	Standard/Deep
14	25.5	5.25A	Standard/Deep
16	28.2	10.25A	Deep

PANEL ONLY - Stand alone panel (no loop load, no network card)			
30 Hours Standby			
Loops	Min. Battery Capacity (Ah)	Power Supply (table 1)	Enclosure (table 2)
2	14.9	5.25A	Standard/Deep
4	18	5.25A	Standard/Deep
6	20.7	5.25A	Standard/Deep
8	24.1	5.25A	Standard/Deep
10	26.1	10.25A	Deep
12	28.5	10.25A	Deep
14	31.5	10.25A	Deep
16	35	10.25A	Deep

PANEL ONLY - Stand alone panel (no loop load, no network card)			
48 Hours Standby			
Loops	Min. Battery Capacity (Ah)	Power Supply (table 1)	Enclosure (table 2)
2	23.5	5.25A	Standard/Deep
4	28.3	10.25A	Deep
6	32.6	10.25A	Deep
8	38.1	10.25A	Deep
10	41.2	10.25A	Deep
12	44.9	10.25A	Deep
14	49.8	Dual 10.25A	Deep + Remote
16	55.2	Dual 10.25A	Deep + Remote

PANEL ONLY - Stand alone panel (no loop load, no network card)			
72 Hours Standby			
Loops	Min. Battery Capacity (Ah)	Power Supply (table 1)	Enclosure (table 2)
2	34.9	10.25A	Deep
4	42.1	10.25A	Deep
6	48.5	Dual 10.25A	Deep + Remote
8	56.7	Dual 10.25A	Deep + Remote
10	61.3	Dual 10.25A	Deep + Remote
12	66.8	Dual 10.25A	Deep + Remote
14	74.1	Dual 10.25A	Deep + Remote
16	82.2	Dual 10.25A	Deep + Remote

PANEL ONLY - Networked panel (no loop load, network card fitted)			
24 Hours Standby			
Loops	Min. Battery Capacity (Ah)	Power Supply (table 1)	Enclosure (table 2)
2	13.9	5.25A	Standard/Deep
4	16.4	5.25A	Standard/Deep
6	18.5	5.25A	Standard/Deep
8	21.3	5.25A	Standard/Deep
10	22.9	5.25A	Standard/Deep
12	24.8	5.25A	Standard/Deep
14	27.3	10.25A	Deep
16	30.1	10.25A	Deep

PANEL ONLY - Networked panel (no loop load, network card fitted)			
30 Hours Standby			
Loops	Min. Battery Capacity (Ah)	Power Supply (table 1)	Enclosure (table 2)
2	17.2	5.25A	Standard/Deep
4	20.2	5.25	Standard/Deep
6	23	5.25	Standard/Deep
8	26.4	10.25	Deep
10	28.4	10.25	Deep
12	30.7	10.25	Deep
14	33.8	10.25	Deep
16	37.3	10.25	Deep

PANEL ONLY - Networked panel (no loop load, network card fitted)			
48 Hours Standby			
Loops	Min. Battery Capacity (Ah)	Power Supply (table 1)	Enclosure (table 2)
2	27.1	10.25A	Deep
4	31.9	10.25A	Deep
6	36.2	10.25A	Deep
8	41.7	10.25A	Deep
10	44.8	10.25A	Deep
12	48.5	Dual 10.25A	Deep + Remote
14	53.4	Dual 10.25A	Deep + Remote
16	58.9	Dual 10.25A	Deep + Remote

PANEL ONLY - Networked panel (no loop load, network card fitted)			
72 Hours Standby			
Loops	Min. Battery Capacity (Ah)	Power Supply (table 1)	Enclosure (table 2)
2	40.2	10.25A	Deep
4	47.5	Dual 10.25A	Deep + Remote
6	53.9	Dual 10.25A	Deep + Remote
8	62.1	Dual 10.25A	Deep + Remote
10	66.7	Dual 10.25A	Deep + Remote
12	72.2	Dual 10.25A	Deep + Remote
14	79.4	Dual 10.25A	Deep + Remote
16	87.6	Dual 10.25A	Deep + Remote

TYPICAL LOOP LOADING (table 3) - Stand alone panel (no network card fitted)			
24 Hours Standby			
Loops	Min. Battery Capacity (Ah)	Power Supply (table 1)	Enclosure (table 2)
2	14.5	5.25A	Standard/Deep
4	19.4	5.25A	Standard/Deep
6	24.7	5.25A	Standard/Deep
8	29.8	10.25A	Deep
10	33.3	10.25A	Deep
12	37.6	10.25A	Deep
14	42.5	10.25A	Deep
16	47.8	Dual 10.25A	Deep + Remote

TYPICAL LOOP LOADING (table 3) - Stand alone panel (no network card fitted)			
30 Hours Standby			
Loops	Min. Battery Capacity (Ah)	Power Supply (table 1)	Enclosure (table 2)
2	17.9	5.25A	Standard/Deep
4	23.9	5.25A	Standard/Deep
6	29.6	10.25A	Deep
8	36.0	10.25A	Deep
10	40.9	10.25A	Deep
12	46.2	Dual 10.25A	Deep + Remote
14	52.3	Dual 10.25A	Deep + Remote
16	58.7	Dual 10.25A	Deep + Remote

TYPICAL LOOP LOADING (table 3) - Stand alone panel (no network card fitted)			
48 Hours Standby			
Loops	Min. Battery Capacity (Ah)	Power Supply (table 1)	Enclosure (table 2)
2	28	10.25A	Deep
4	37.4	10.25A	Deep
6	47.4	Dual 10.25A	Deep + Remote
8	57.1	Dual 10.25A	Deep + Remote
10	63.8	Dual 10.25A	Deep + Remote
12	72	Dual 10.25A	Deep + Remote
14	81.5	Dual 10.25A	Deep + Remote
16	91.5	Dual 10.25A	Deep + Remote

TYPICAL LOOP LOADING (table 3) - Stand alone panel (no network card fitted)			
72 Hours Standby			
Loops	Min. Battery Capacity (Ah)	Power Supply (table 1)	Enclosure (table 2)
2	41.5	10.25A	Deep
4	55.3	Dual 10.25A	Deep + Remote
6	70.1	Dual 10.25A	Deep + Remote
8	84.3	Dual 10.25A	Deep + Remote
10	94.4	10.25A + External	Deep + External
12	106.5	10.25A + External	Deep + External
14	120.4	10.25A + External	Deep + External
16	135.2	10.25A + External	Deep + External

TYPICAL LOOP LOADING (table 3) - Networked panel (network card fitted)			
24 Hours Standby			
Loops	Min. Battery Capacity (Ah)	Power Supply (table 1)	Enclosure (table 2)
2	16.3	5.25A	Standard/Deep
4	21.2	5.25A	Standard/Deep
6	26.5	10.25A	Deep
8	31.6	10.25A	Deep
10	35.1	10.25A	Deep
12	39.4	10.25A	Deep
14	44.4	10.25A	Deep
16	49.6	Dual 10.25A	Deep + Remote

TYPICAL LOOP LOADING (table 3) - Networked panel (network card fitted)			
30 Hours Standby			
Loops	Min. Battery Capacity (Ah)	Power Supply (table 1)	Enclosure (table 2)
2	20.1	5.25A	Standard/Deep
4	26.2	10.25A	Deep
6	31.8	10.25A	Deep
8	38.2	10.25A	Deep
10	43.2	10.25A	Deep
12	48.5	Dual 10.25A	Deep + Remote
14	54.5	Dual 10.25A	Deep + Remote
16	61.0	Dual 10.25A	Deep + Remote

TYPICAL LOOP LOADING (table 3) - Networked panel (network card fitted)			
48 Hours Standby			
Loops	Min. Battery Capacity (Ah)	Power Supply (table 1)	Enclosure (table 2)
2	31.6	10.25A	Deep
4	41	10.25A	Deep
6	51	Dual 10.25A	Deep + Remote
8	60.7	Dual 10.25A	Deep + Remote
10	67.4	Dual 10.25A	Deep + Remote
12	75.6	Dual 10.25A	Deep + Remote
14	85.1	Dual 10.25A	Deep + Remote
16	95.1	10.25A + External	Deep + Ext

TYPICAL LOOP LOADING (table 3) - Networked panel (network card fitted)			
72 Hours Standby			
Loops	Min. Battery Capacity (Ah)	Power Supply (table 1)	Enclosure (table 2)
2	46.8	Dual 10.25A	Deep + Remote
4	60.7	Dual 10.25A	Deep + Remote
6	75.4	Dual 10.25A	Deep + Remote
8	89.7	Dual 10.25A	Deep + Remote
10	99.7	10.25A + External	Deep + External
12	111.8	10.25A + External	Deep + External
14	125.7	10.25A + External	Deep + External
16	140.5	10.25A + External	Deep + External

Table 1	
Power Supply	Description
5.25A	5.25A Power Supply (supplied with panel).
10.25A	10.25A Power Supply (supplied with panel).
Dual 10.25A	10.25A Power Supply (supplied with panel) plus additional boxed 10.25A power supply - with space for up-to 45Ah batteries.
10.25A + External	10.25A Power Supply (supplied with panel) plus additional boxed third party power supply - with space for greater than 45Ah batteries.

Table 2	
Qty	Description
Standard/Deep	Standard or Deep enclosure.
Deep	Deep enclosure.
Deep + Remote	Deep Enclosure and additional 10.25A Power Supply.
Deep + External	Deep Enclosure and external third party power supply.

Table 3		
Average Loading calculation uses Per 2 loop card (110 addresses per loop)		
Qty	Description	Typical Model (Hochiki)
100	Photoelectric Detectors	ALN-EN
40	Multisensors	ACC-EN
10	Heat Detectors	ATJ-EN
10	Call Points	HCP-E
60	Base Sounder Beacons	YBO-BSB2

Appendix C

Compatible Standby Batteries

This section describes approved standby-batteries from Power-Sonic and Yuasa that fit in standard and deep cabinets of the FACP (Fire Alarm Control Panel).

Power supplies of the FACP including the 10.25 Amp and 5.25 Amp are compatible with all standby-batteries approved for operation in standard and deep cabinets.

All batteries are to be paired, wired in series (for 24V) using the battery jumper leads supplied.

2 to 8 Loop FACP - Standard size cabinet							
12Ah		17Ah	18Ah	24Ah	26Ah	38Ah	45Ah
Yuasa NP12-12	Power-Sonic PS-12120	Yuasa NP17-12	Power-Sonic PS-12180	Yuasa NP24-12	Power-Sonic PS-12260	Yuasa NP38-12	Power-Sonic PS-12450
Yes	Yes	Yes	Yes	Yes	Yes	No	No

2 to 8 Loop FACP - Deep size cabinet							
12Ah		17Ah	18Ah	24Ah	26Ah	38Ah	45Ah
Yuasa NP12-12	Power-Sonic PS-12120	Yuasa NP17-12	Power-Sonic PS-12180	Yuasa NP24-12	Power-Sonic PS-12260	Yuasa NP38-12	Power-Sonic PS-12450
Yes	Yes	Yes	Yes	Yes	Yes	Yes	Yes

2 to 16 Loop FACP - Standard size cabinet							
12Ah		17Ah	18Ah	24Ah	26Ah	38Ah	45Ah
Yuasa NP12-12	Power-Sonic PS-12120	Yuasa NP17-12	Power-Sonic PS-12180	Yuasa NP24-12	Power-Sonic PS-12260	Yuasa NP38-12	Power-Sonic PS-12450
Yes	Yes	Yes	Yes	Yes	Yes	No	No

2 to 16 Loop FACP - Deep size cabinet							
12Ah		17Ah	18Ah	24Ah	26Ah	38Ah	45Ah
Yuasa NP12-12	Power-Sonic PS-12120	Yuasa NP17-12	Power-Sonic PS-12180	Yuasa NP24-12	Power-Sonic PS-12260	Yuasa NP38-12	Power-Sonic PS-12450
Yes	Yes	Yes	Yes	Yes	Yes	Yes	Yes