

SmartCell

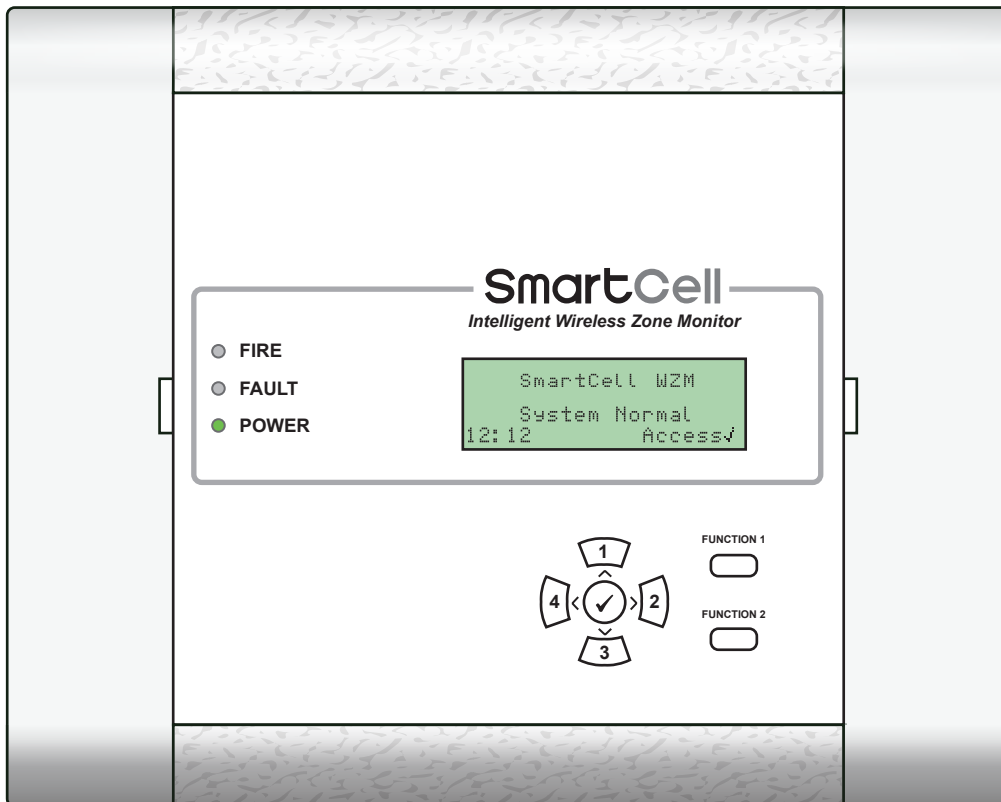

Intelligent Wireless Zone Monitor Programming Guide



Welcome to SmartCell



Table of contents

Introduction

5

General warnings	6	WZM fascia	16
Handling precautions	6	WZM status LEDs	17
Packaging	6	WZM buttons	17
PIN numbers	6	WZM display	18
Equipment familiarisation	7	Access level 1 entry	18
System overview	8	Access level 3 entry	19
System design	9	Example menu display	19
Device log on methods	12	Fault event display	20
Device log on points	13	Fire event display	20
WZM connections	15	How to view more information	20

System setup

21

System setup introduction	22	Set time & date	30
Important system setup notes	22	Install devices	31
Side cover removal	22	Add devices to the system	32
Open WZM	23	Device attributes	33
Optional door removal	23	Device location text	35
Cable entry	24	Text entry	36
Fix WZM to wall	24	Set the panel type	37
Addressable fire system wiring	25	Sounder tones	38
Conventional fire system wiring	26	Sounder duration	39
Re-fit door	28	Sounder activation method	40
Connect backup battery	28	Pulsed output	41
Remove 3V battery tab	29	Device indicator operation	43
Apply power	29		

System testing 45

Test devices	46	Device battery levels	48
Device signal levels	47		

Diagnostics 49

Fault rectification	50	How to improve device signal levels	52
Signal level requirements	51		

WZM menus 55

Access level 3 tree view	54	WZM information	68
Access level 3 menu options	57	Language	71
Maintenance/test	59	Reports	71
Device options	61	Access level 4	72
WZM settings	66	Logout	72

Product conformance 73

Device listing	74
----------------	----

Introduction

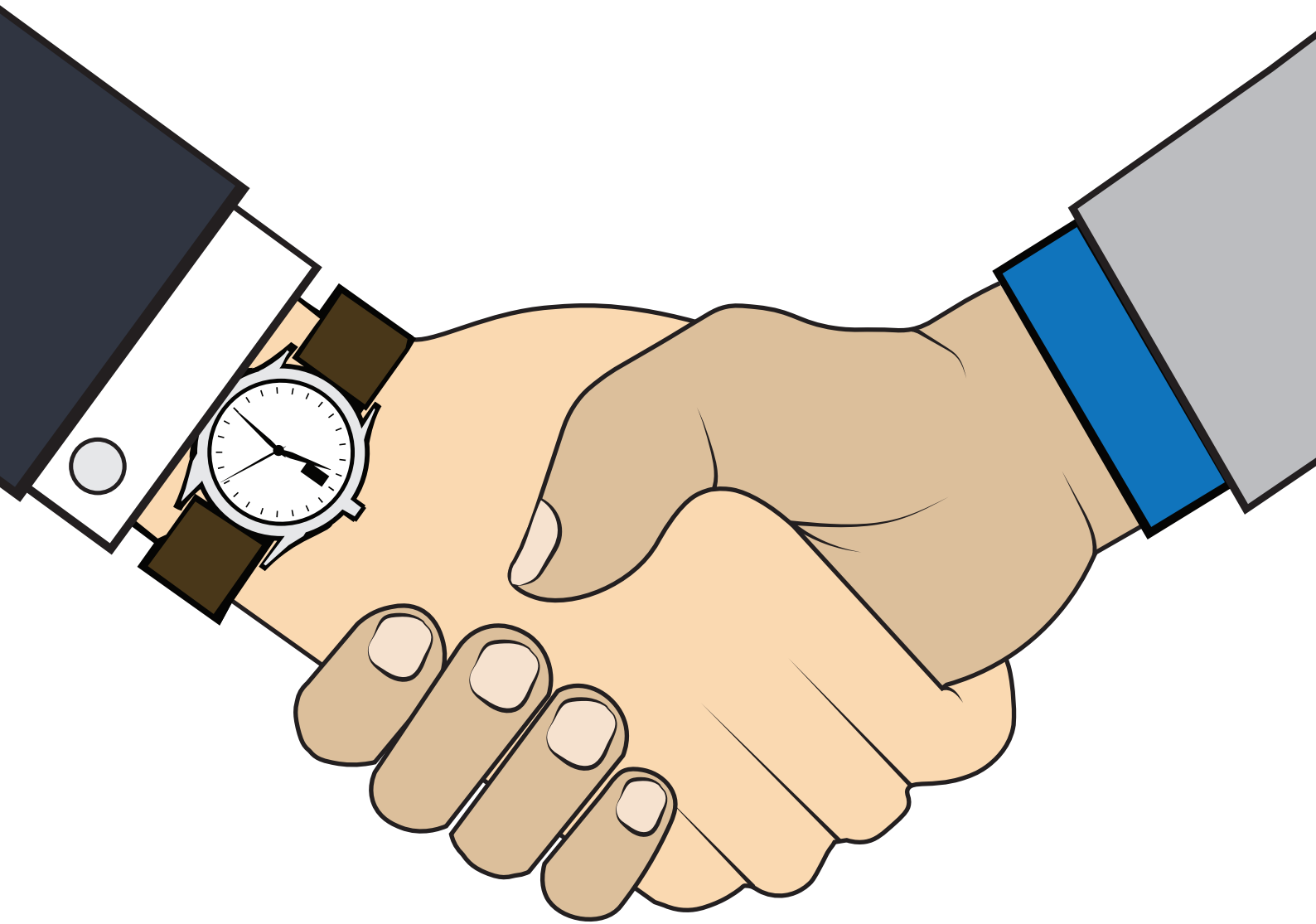



General warnings

The system should only be installed and programmed by a fully trained competent person.

The procedures outlined in this programming guide and associated instructions must be carefully followed.

All of the options detailed within this programming manual are available via the SmartCell configuration tool. See the configuration tool's inbuilt engineer manual for operational details.



Handling precautions

General: care should be taken when handling this wireless fire system. Avoid dropping any of the parts on to hard surfaces, as damage may occur to the case and internal circuitry.

ESD precautions: This wireless fire system includes components that are susceptible to damage from Electrostatic Discharge (ESD). Permanent damage may be caused to these components through routine handling if precautions are not observed. To reduce the risk of damage from ESD, the following precautions should be observed.

Minimise the handling of PCBs which contain static sensitive components.

Where handling is unavoidable, always ensure that you have taken adequate earthing precautions. An earthed wrist strap is recommended.

When storing or transporting a “loose” PCB, always use a container, which has been designed and manufactured with ESD protective properties.

Avoid placing static sensitive devices on any surfaces, which may increase the risk of a static discharge

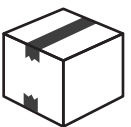

Packaging

Products should be kept in their packaging until they are due to be installed, to minimise the risk of damage. Retain all packaging until the installation activities have been completed. Should any product be found to be surplus to requirements, or require returning to your supplier, the original packaging should be used.



PIN numbers

It is advised that you change the default PIN immediately on first installation and consider changing frequently to prevent unauthorised access.

Equipment familiarisation

It is important to establish which devices have been supplied for the installation. Examples of each of the systems products are shown below:

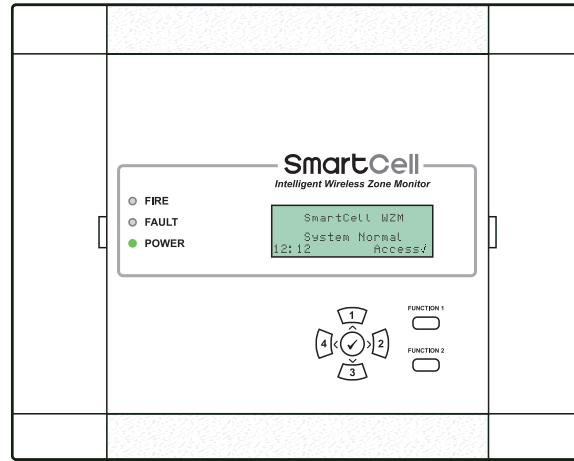

Wireless zone monitor

Wireless fire devices

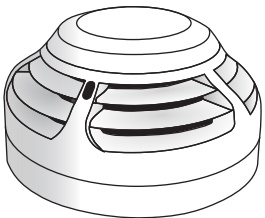

Wireless dual smoke / heat detector

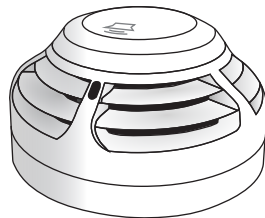

Wireless dual smoke / heat detector & combined sounder

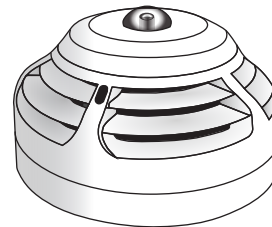

Wireless dual smoke / heat detector & combined sounder beacon

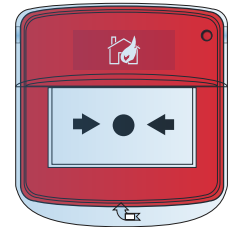

Wireless manual fire call point

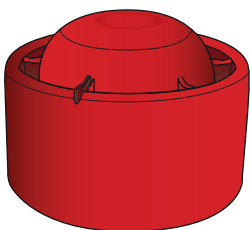

Wireless sounder

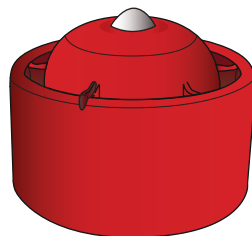

Wireless sounder & ceiling beacon

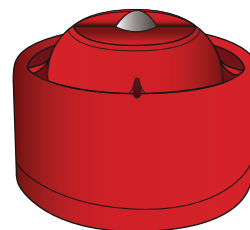

Wireless sounder & wall beacon

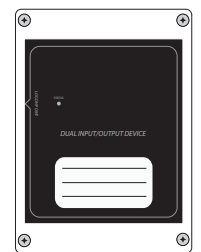

Wireless input / output device

System overview

The Intelligent Wireless Zone Monitor (WZM) allows for 16 SmartCell wireless devices to be added to conventional or addressable fire system.

Typical addressable fire system connection

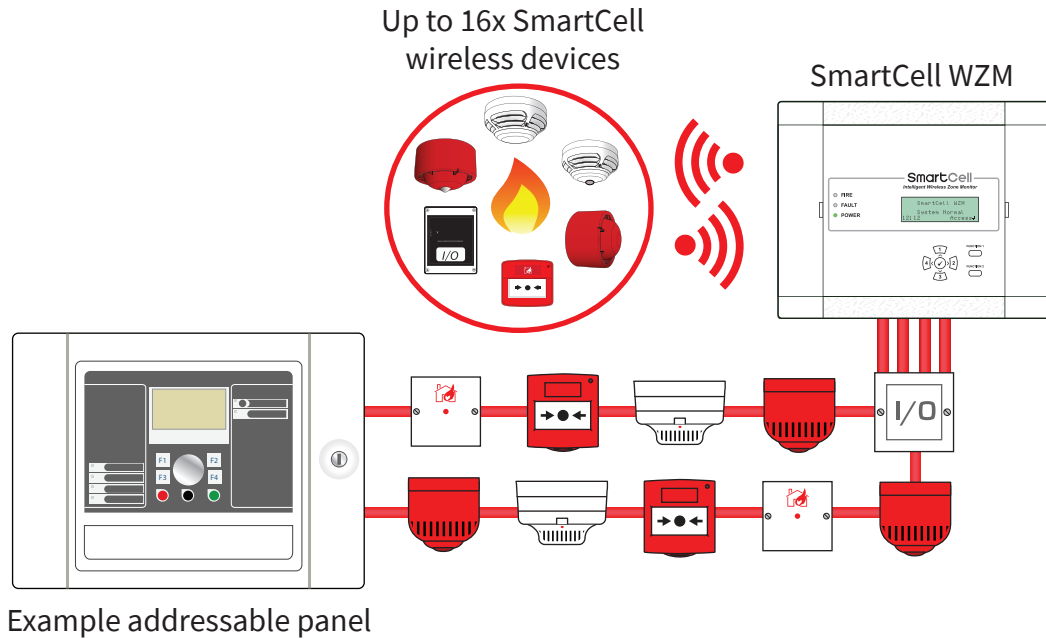

Typical conventional fire system connection

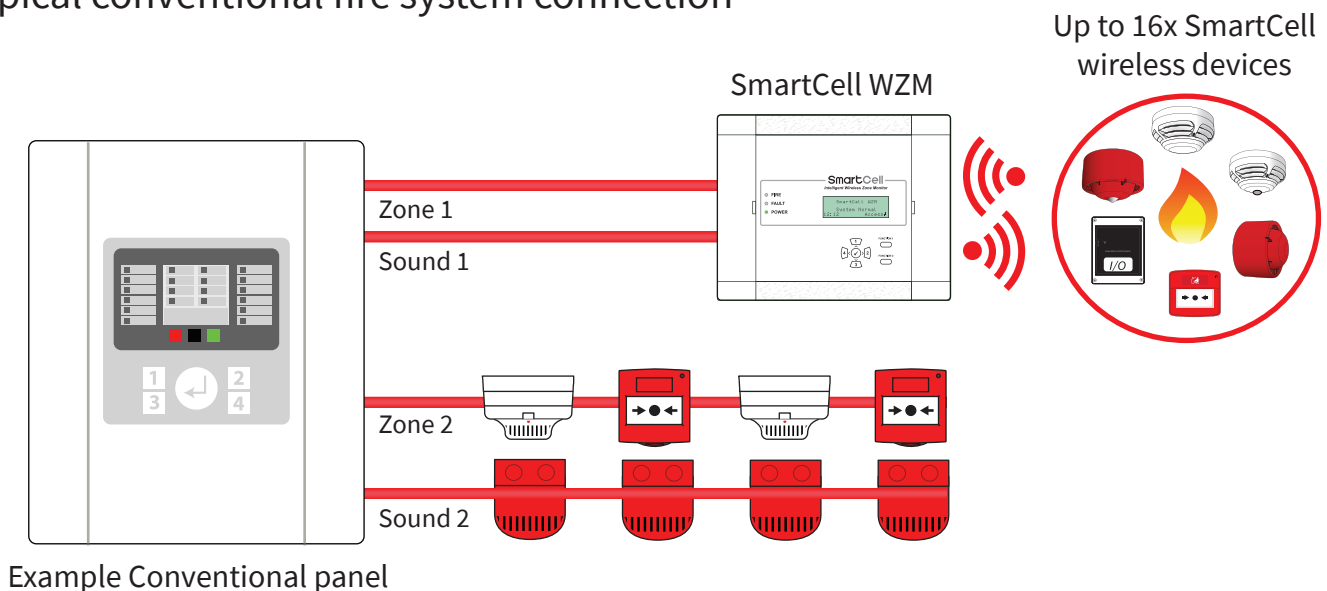

The WZM is programmed for operation with Conventional or Addressable fire control panels in the 'WZM Settings' menu. The default setting is 'Conventional'. See page 35 for more information.

System design

All installation work should be carried out in accordance with the system design.

Wireless zone monitor

230 VAC and 24 VDC powered wireless control panels are available.

Communication between devices and the WZM is bidirectional and operates in the European harmonised 868 MHz frequency band. The WZM's features are detailed in the 'Controls and Displays' section.

The WZM can be connected to conventional and addressable fire systems. See pages 25 to 26 for wiring configurations.

Wireless dual smoke and heat detectors

Detectors are available as standalone devices and alternatively with integrated sounders or integrated sounder and beacons. Their fire detection can be configured for smoke, heat or dual smoke and heat.

Available sensitivities are listed below. When configuring as dual detectors, one smoke and one heat sensitivity is selected. If either of these settings is reached, the detector will send an alarm condition to the WZM. The detectors are programmable via the WZM.

Smoke sensitivities	Heat sensitivities
Normal	58 ° c static (A2S)
Normal + AVF *	58 ° c rate of rise (A2R)
	72 ° c static (BS)
	72 ° c rate of rise (BR)

































* Alarm Verification Feature (AVF). Upon receipt of a fire alarm condition, the WZM waits to check that the device remains alarm, before acting on the event.

Wireless fire sounders and beacons

Sounders can be set to high or low volume, whilst sounder or beacons can also be independently enabled or disabled. The default fire sounder tone is tone 5.

Sounders have 31 tones available, that can be played on the configuration tool for verification.

Available tones are shown overleaf:

TONE	TONE TYPE	TONE DESCRIPTION / APPLICATION
1.		970Hz
2.		800Hz/970Hz at 2Hz
3.		800Hz - 970Hz at 1Hz
4.		970Hz 1s OFF / 1s ON
5.		970Hz, 0.5s / 630Hz at 1 Hz **Default fire tone**
6.		554Hz, 0.1s / 440Hz, 0.4s (AFNOR NF S 32 001)
7.		500 - 1200Hz, 3.5s / 0.5s OFF (NEN 2575:2000 Dutch slow whoop)
8.		420Hz 0.6s ON / 0.6s OFF (Australia AS1670 Alert tone)
9.		1000 - 2500Hz, 0.5s/ 0.5s OFF x 3/1.5s OFF (AS1670 Evacuation)
10.		550Hz / 440Hz at 0.5Hz
11.		970Hz, 0.5s ON / 0.5s OFF x 3 / 1.5s OFF (ISO 8201)
12.		2850Hz, 0.5s ON / 0.5s OFF x 3 / 1.5s OFF (ISO 8201)
13.		1200Hz - 500Hz at 1Hz (DIN 33 404)
14.		400Hz
15.		550Hz, 0.7s / 1000Hz, 0.33s
16.		1500Hz - 2700Hz at 3Hz
17.		750Hz
18.		2400Hz
19.		660Hz
20.		660Hz 1.8s ON / 1.8s OFF
21.		660Hz 0.15s ON / 0.15s OFF
22.		510Hz, 0.2s / 610Hz, 0.2s
23.		800 / 1000Hz 0.5s each (1Hz)
24.		250Hz - 1200Hz at 12Hz
25.		500Hz - 1200Hz at 0.33Hz
26.		2400Hz - 2900Hz at 9Hz **Default information tone**
27.		2400Hz - 2900Hz at 3Hz
28.		500 - 1200Hz, 0.5s/ 0.5s OFF x 3/1.5s OFF (AS1670 Evacuation)
29.		800Hz - 970Hz at 9Hz
30.		800Hz - 970Hz at 3Hz
31.		800Hz, 0.25s ON / 1s OFF
32.		500Hz - 1200Hz, 3.75s / 0.25s OFF (AS2220)

Note: Tones 1, 4, 5 and 7 are EN54-3 approved tones.

Note: Default sounder operation is global. Alternative operation, such as zonal and two stage, plus sounder and output delays are also available, via the SmartCell configuration tool.

Input / output devices

Input / output devices have two resistor monitored fire inputs and two fire relay outputs. Both fire relay outputs are rated 1 A at 30 VDC.

The device's two relay outputs are programmable. Upon a fire condition, both outputs will automatically change state. The outputs can be independently programmed to return to their normal state upon either, when the control panel's 'Silence' button is pressed, or when the control panel's 'Reset' button is pressed.

Device log on methods

Wireless devices can be programmed to the wireless control panel in two ways, for maximum flexibility. They are as follows:

Method 1 ‘at WZM’

This method is accessed at the WZM and involves powering the device at the WZM, by inserting the device’s batteries. Devices can therefore be added to the system, prior to installing them into location.

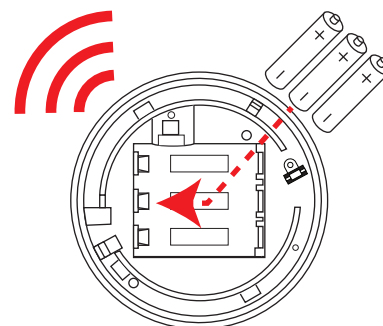

Method 2 ‘at device location’

This method is accessed at the control panel and involves applying the supplied magnet to the device. Devices can therefore be added to the system, with device batteries already fitted. E.g. when fitted in its final device location.

The magnet must be held in place (on the device log on point) for 4 seconds. The device’s LED will flash by way of confirmation.

Refer to the ‘Device log on points’ section for details on each device’s log on point.

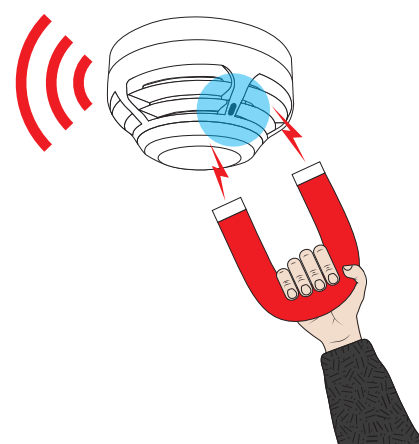

Device log on points

Detector (incl. sounder and beacon variants)

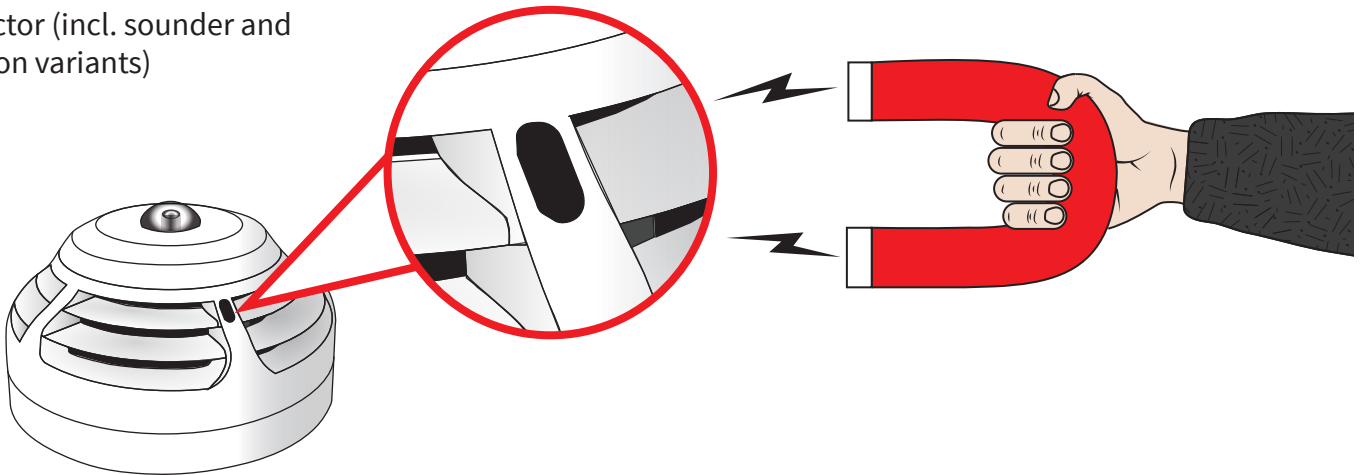

Sounder (incl. beacon variants)

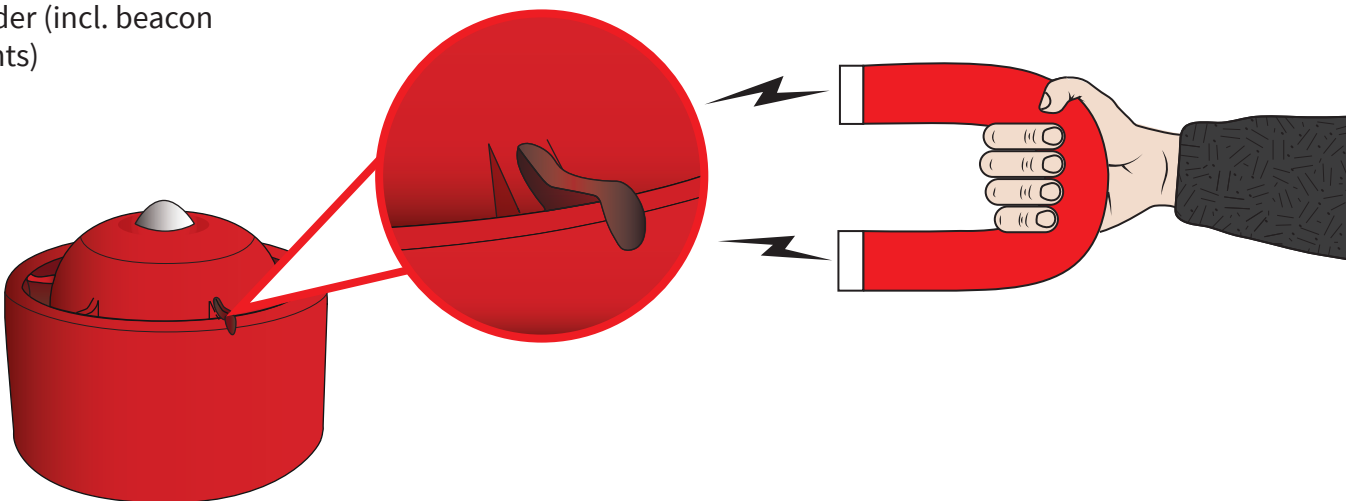

Call Point

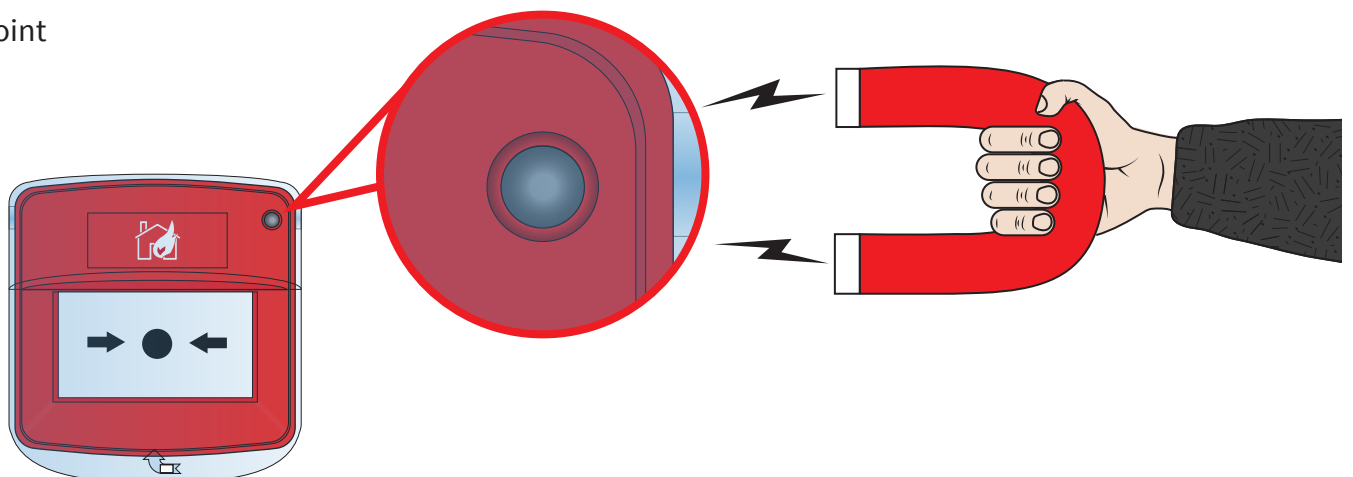

Dual input dual output device

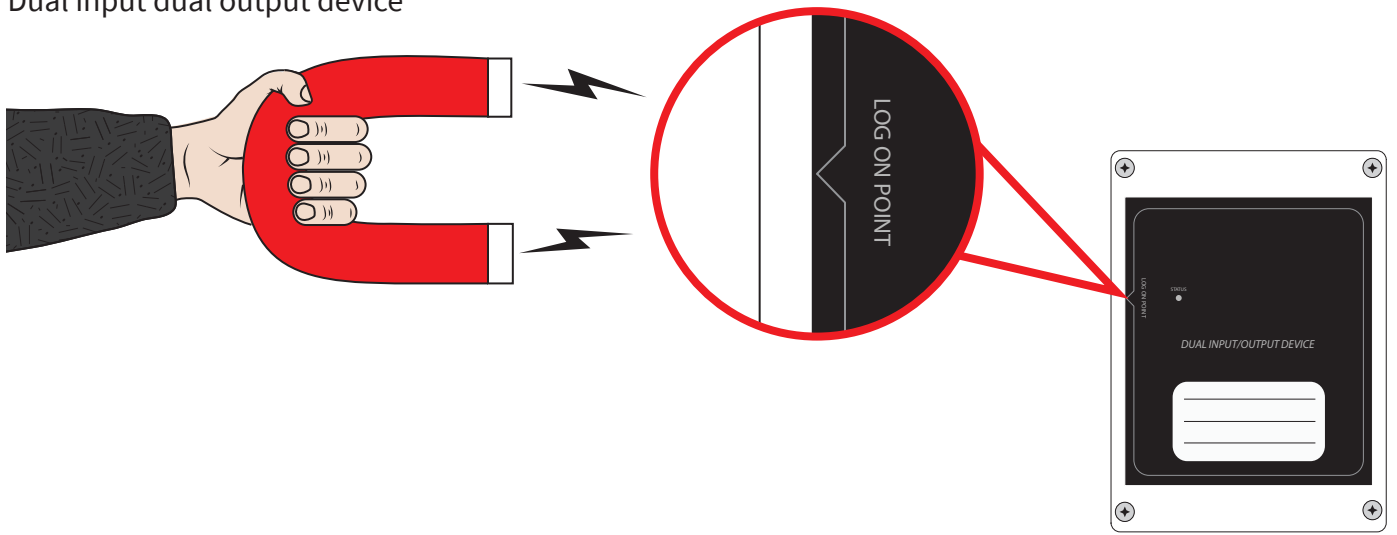

WZM connections

The WZM has a number of connections and features, as detailed below:

Conventional control panel connections

80 character LCD display

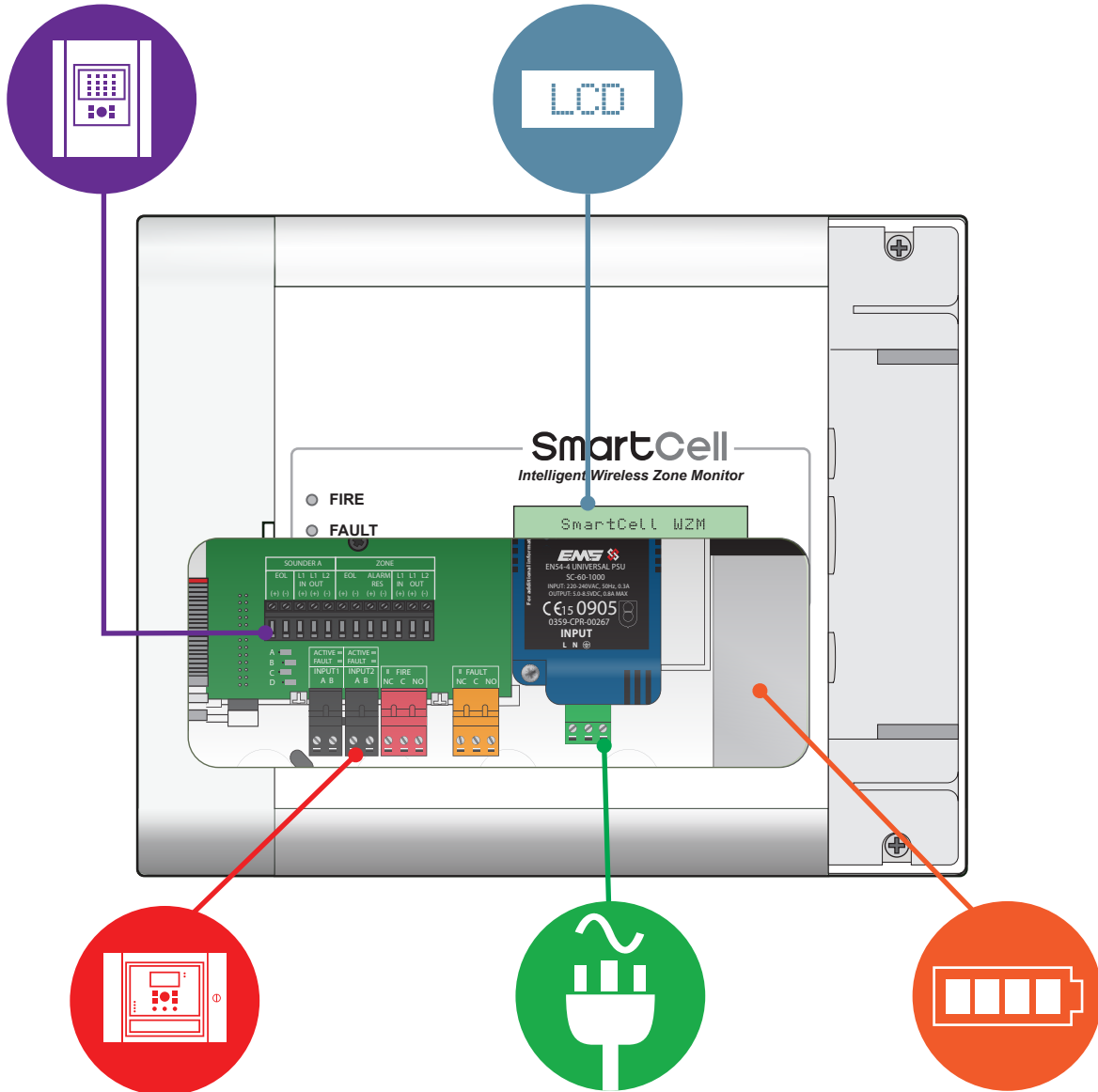

Addressable control panel connections

230 VAC powered*

48 hr battery back up

* An alternative 24 VDC version WZM is also available for use with a separate power supply for extended battery standby time.

WZM fascia

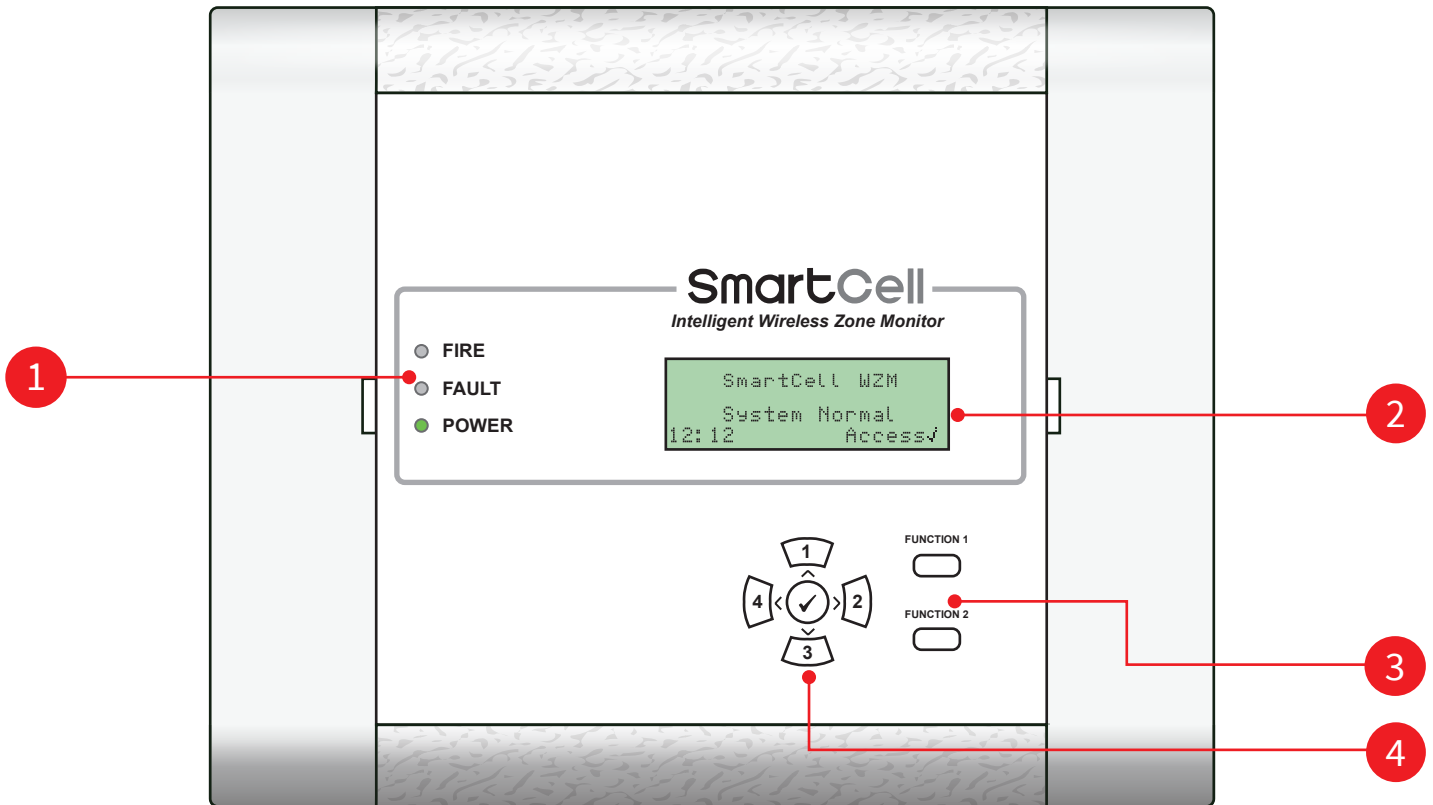

The WZM provides status information via the display and status lamps. The WZM's functions are achieved via the entry of a user access code.

The WZM's features are shown below.









- 1 Status LEDs
- 2 80 character display
- 3 Function buttons
- 4 Navigation & confirmation buttons

WZM Status LEDs

LED Indicator	LED Colour	Function
FIRE		Illuminates when any device is in fire alarm condition.
FAULT		Illuminates when any fault condition is present at the WZM itself or if an associated device is in fault.
POWER		Indicates a good power supply.

WZM buttons

Button	Function
	This button is always active and is used for number entry (number 1) and for upwards menu navigation.
	This button is always active and is used for number entry (number 2) and for forwards menu navigation.
	This button is always active and is used for number entry (number 3) and for downwards menu navigation.
	This button is always active and is used for number entry (number 4) and for backwards menu navigation.
	This button is always active and is used as a menu entry button.
FUNCTION 1 	When a valid User PIN has been entered, pressing the Function 1 button will switch between the first and second language selected for the system. Note: This feature is not currently supported in this version of software.
FUNCTION 2 	When a valid User PIN has been entered, pressing the Function 2 button for 2-3 seconds will send a resynchronisation signal to the WZM's wireless devices.

WZM display

Once the WZM has been fully installed and powered up, the WZM will show the following alternating default 'System Normal' displays.

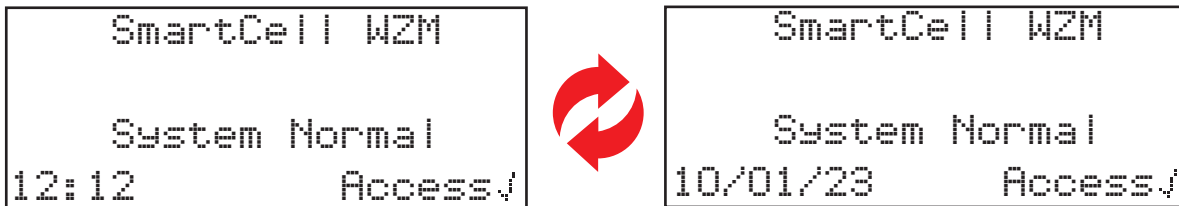

This is described in full below.

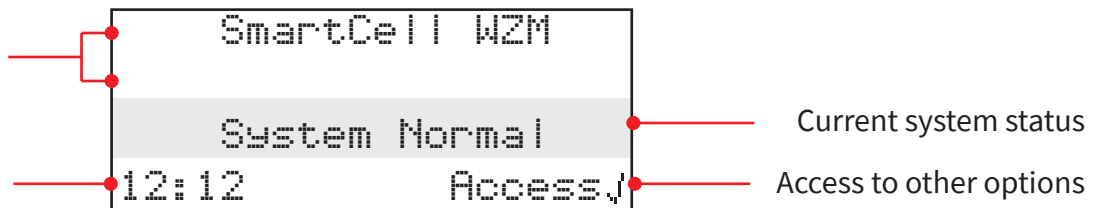

Programmable text that can be changed as required, e.g. site name

The set time and date are alternatively shown here



Entry to the menu and then into the required menu options can be achieved by entering a valid access code and using the WZM's navigation buttons. Exiting from a menu option is achieved automatically via a time-out period, by pressing the  button or by selecting the logout menu option.

Access level 1 entry

No valid access code is required for access level 1. To view events on the WZM, the  button can be pressed to select the type of event to be viewed i.e. faults, disablements etc. The  and  buttons can be used to scroll through these events.





Access level 3 entry

A valid user access code is required for access level 3. One entered the full service menu access structure is available at this level. This is shown and detailed fully in this programming manual.

To enter access level 3 press the  button. The display will change to show:

```
For Access
Enter Code:

Press ✓ To Complete
```

Press the relevant numbered arrows to enter the access level 3 access code required (1=, 2=, 3=, 4=). Access level 3 default access code is 333333. On completion of the last number entered, press the  button. The display will change to briefly show the display below, then the relevant menu options will be available. During this display all buttons are immediately active.

```
* Welcome Service *
  Access Level 3
  Now Available
  All Buttons Active
```

By selecting the access level 3 option and entering the correct access 3 entry code additional menus will be available.

Example menu display

An example display is shown below:

```
→View System Status
  Maintenance/Test
  Device Options
  WZM Settings ◊
```

The menus can be navigated by pressing the  and  buttons until the desired option to be entered has the arrow (→) adjacent to it. Pressing the  button enters this option.

Exiting from a menu option is achieved automatically after two minutes, or by pressing the  button.

Fault event display

An example display is shown below.

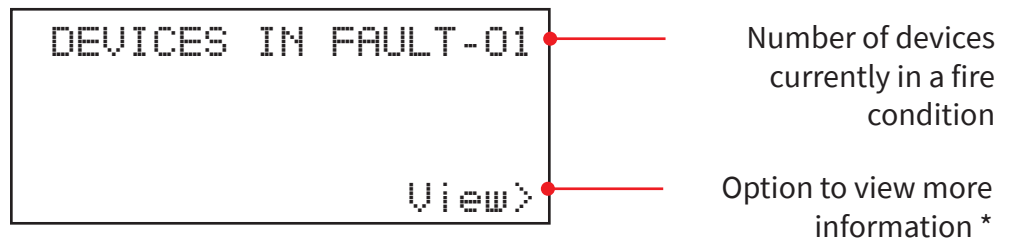

* See the 'How to view more information' section below for further details on this feature.

Fire event display

An example fire event screen is detailed below.

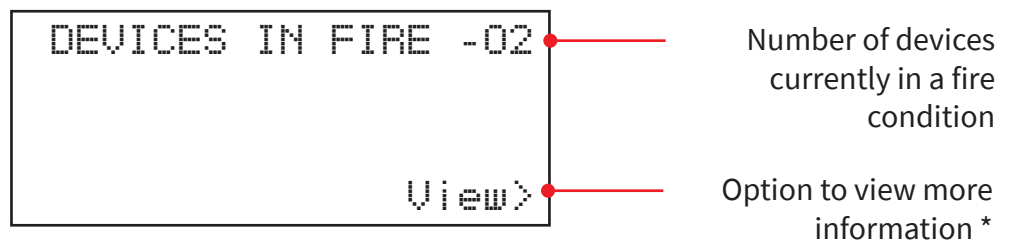



* See the 'How to view more information' section below for further details on this feature.

How to view more information

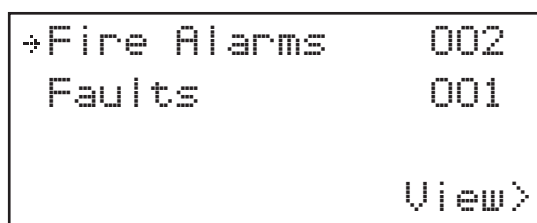
Whilst fire events or fault conditions are present on the system, pressing the  button, will allow the user to view more information:



Press the  and  buttons so that the arrow (→) is highlighting the desired event type, then press the  button. The LCD display will change to show more information as detailed below:

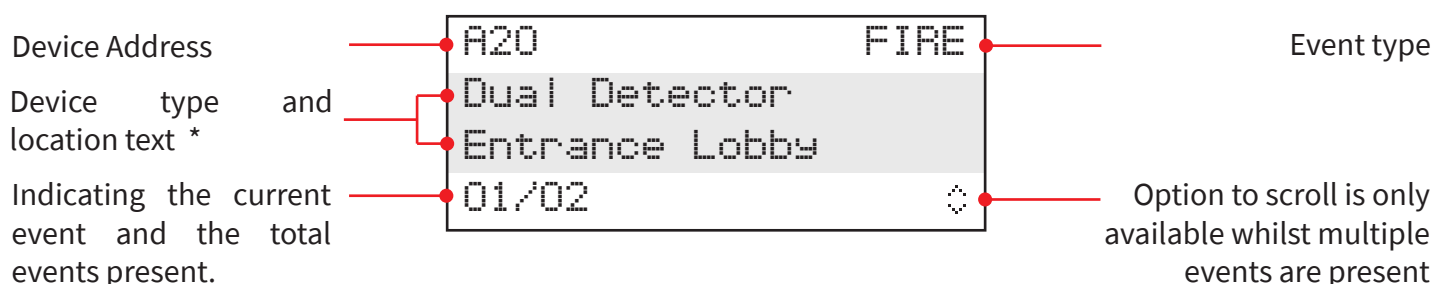

* Note; refer to 'System Setup' section for details on location text programming.

System Setup

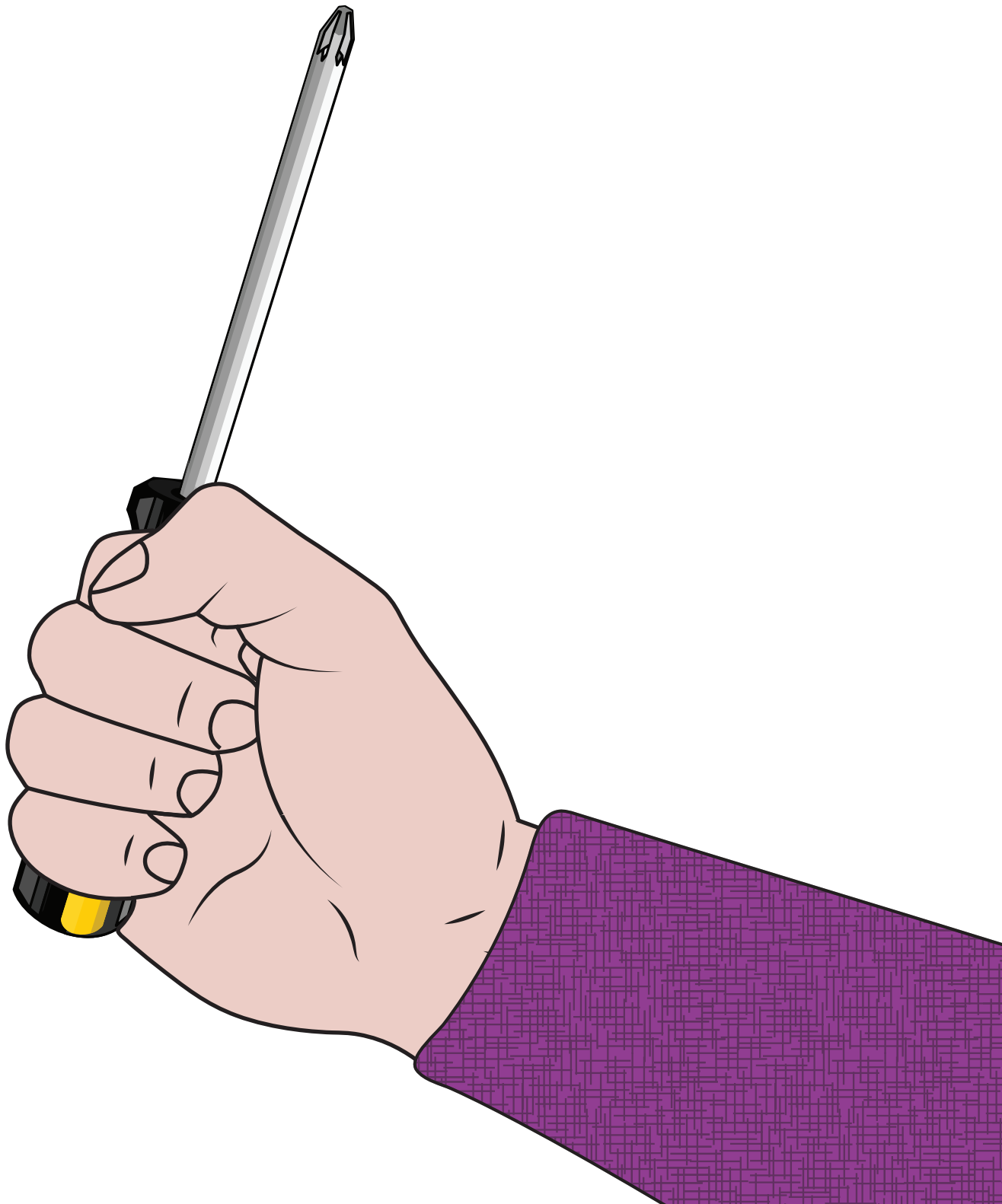

System setup introduction

This system setup section will show you how to configure the WZM and connect it to a fire alarm panel. The 'at WZM' (via power-up) method of adding devices to the WZM will be used. For advanced programming, refer to the 'Panel Menus' section of this document.

Before commencing with the installation, the important notes below must be observed.

Important system setup notes



The installation must conform to applicable local installation codes and should only be installed by a fully trained competent person.



Always select an appropriate device type for the application as per local codes of practice, or as advised by a qualified professional.



The procedures outlined in this installation guide must be carefully followed.



SmartCell devices contain electronics that may be susceptible to damage from Electro Static Discharge (ESD). Take appropriate precautions when handling electronic boards.



To ensure correct operation, products must be used within the specified environmental operating conditions.

Side cover removal

The following steps illustrate how to remove the side covers:

1.

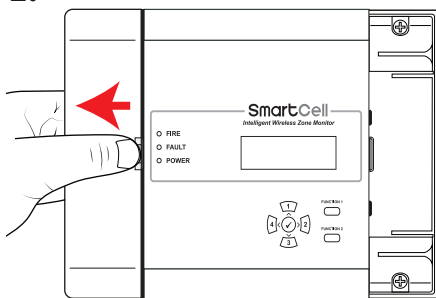

Slide the side cover sideways, creating a gap as shown.

2.

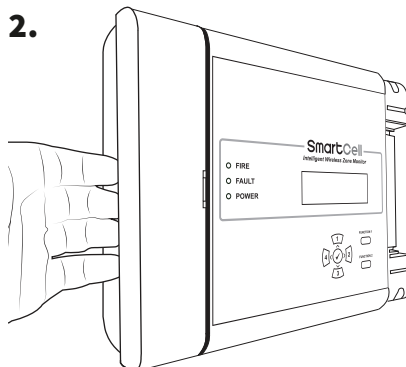

Position your fingers behind the cover's protruding edge.

3.

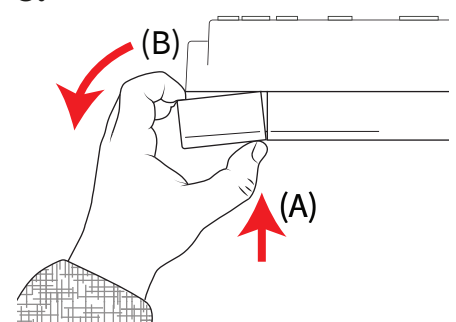

Press the cover's releasing clip with your thumb (A), and simultaneously rotate the side panel anti-clockwise (B), as viewed overhead to remove the cover.

Open WZM

1. Unclip side panel.

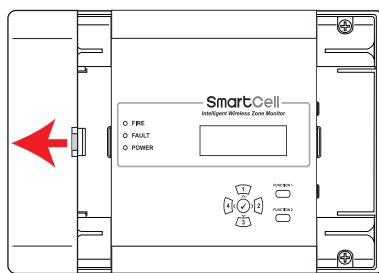

Refer to the 'Side cover removal' section for details.

2. Loosen screws.

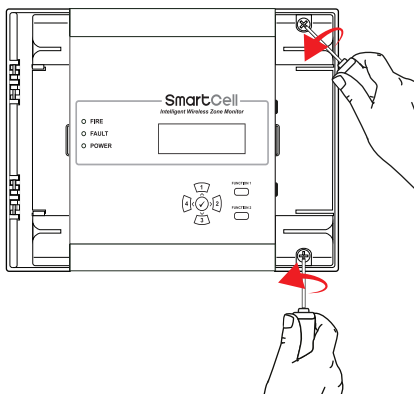

3. Open door.

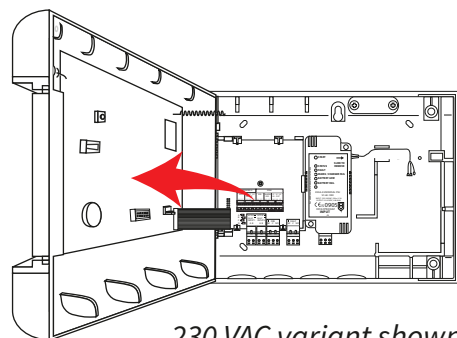

230 VAC variant shown

Optional door removal

Disconnect the ribbon cable, then turn and release the door hinges.

1.

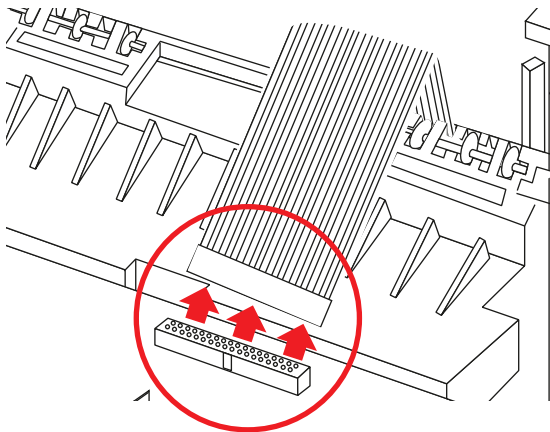

2.

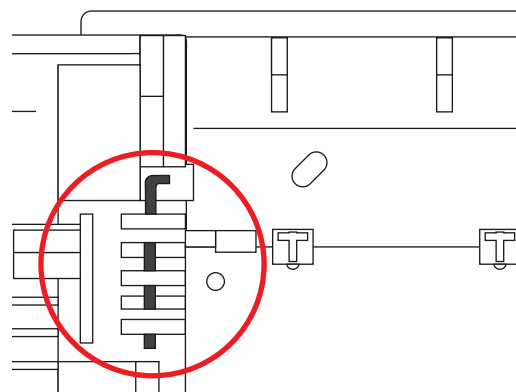

3.

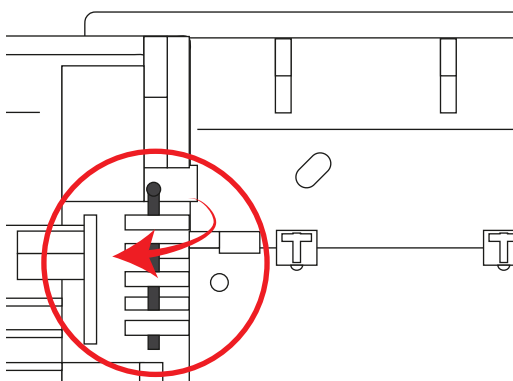

4.

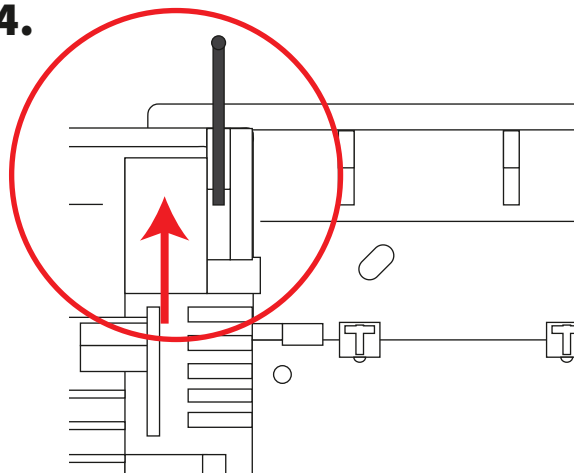

Cable entry

Select cable entry points as required, before fitting to the wall.

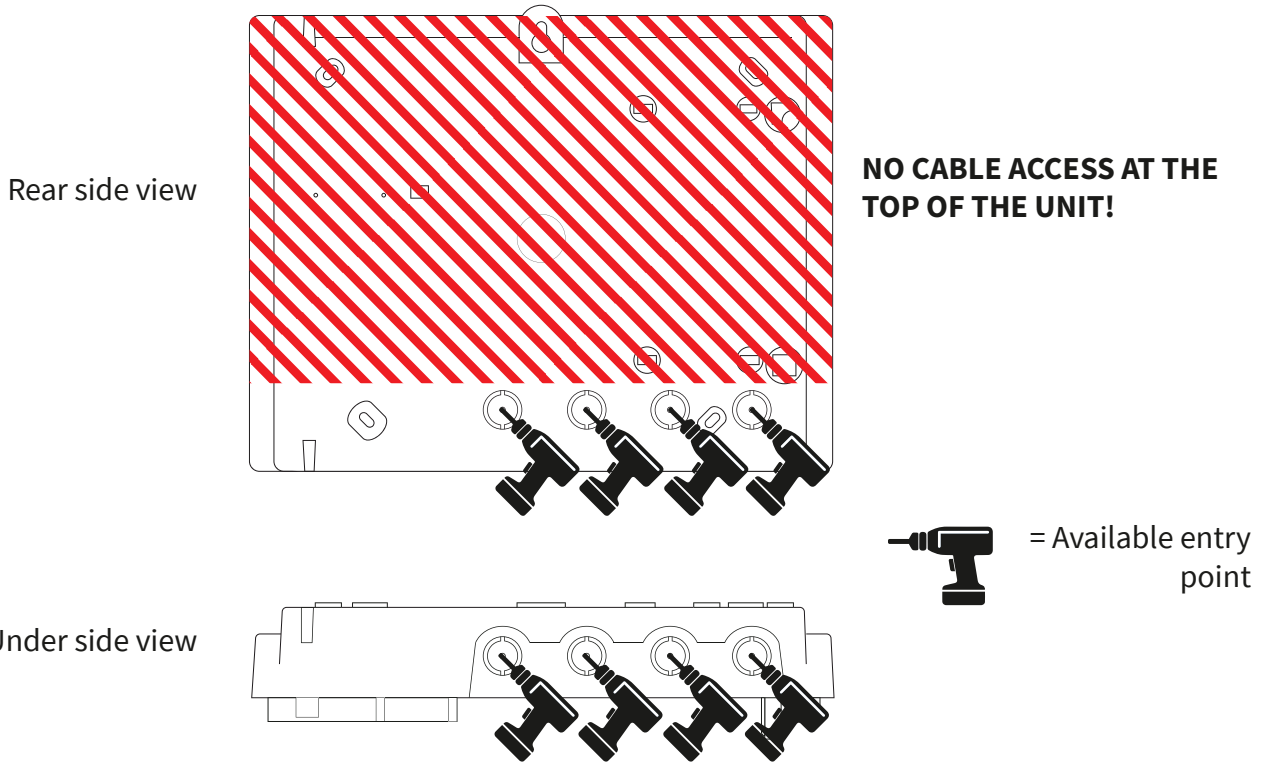

Fix panel to wall

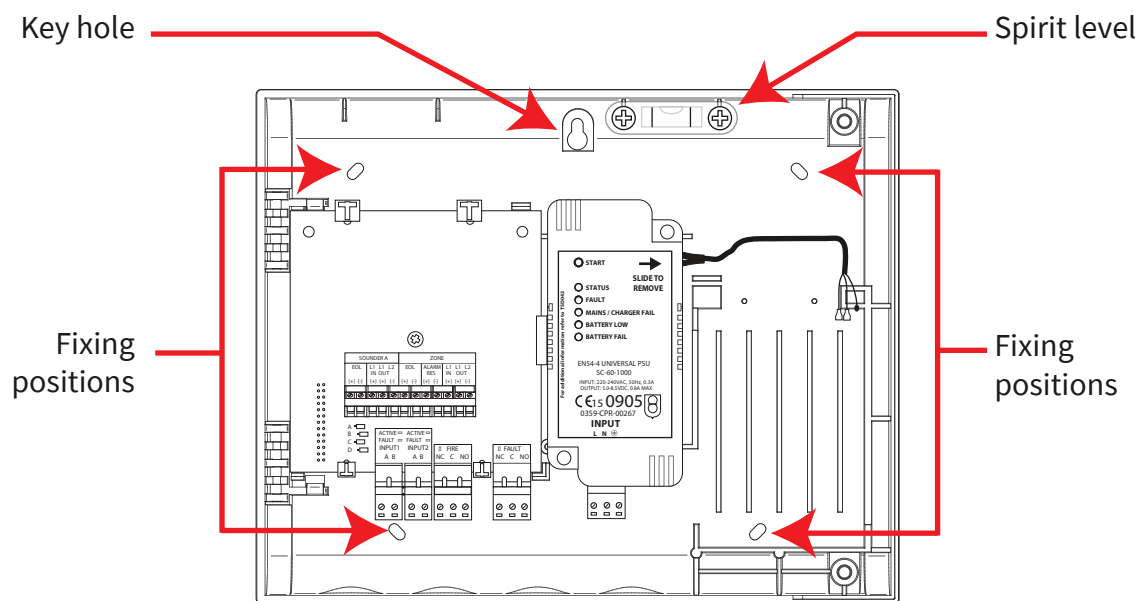

Note: the supplied back box mounting template can be used to drill the fixing positions.

Addressable fire system wiring

- SKIP THIS STEP IF CONNECTING TO A CONVENTIONAL FIRE SYSTEM.
- Wire the inputs as shown below, using the resistor pack provided.
- If an input is not being used, leave the 20 kΩ resistor as factory fitted.
- Both outputs are voltage free and rated 30 V @ 1 A.
- The maximum cable length to connected devices is 10 m.

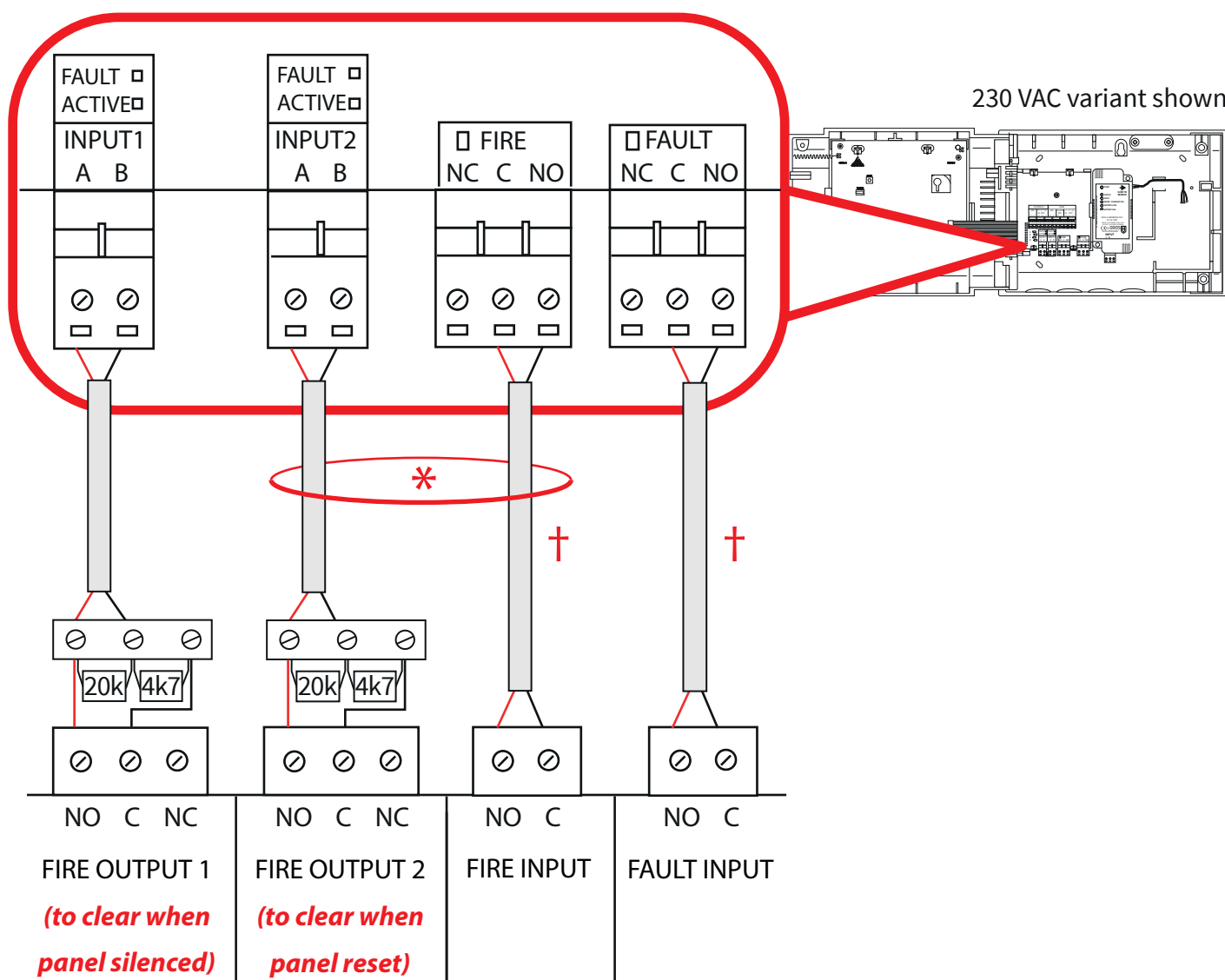

Addressable fire system connections

FOOTNOTES

- * Optional cabling, required only when the following SmartCell devices are added to the WZM; detectors, call points and I/O Units (I/O units when set to 'Off When Reset') - see page 30 for details on this feature.
- † Wiring can be normally open or normally closed operation as required.

Conventional fire system wiring

- SKIP THIS STEP IF CONNECTING TO AN ADDRESSABLE FIRE SYSTEM.
- The WZM must be connected to a dedicated zone and sounder output.
- The maximum cable length to connected devices is 10 m.

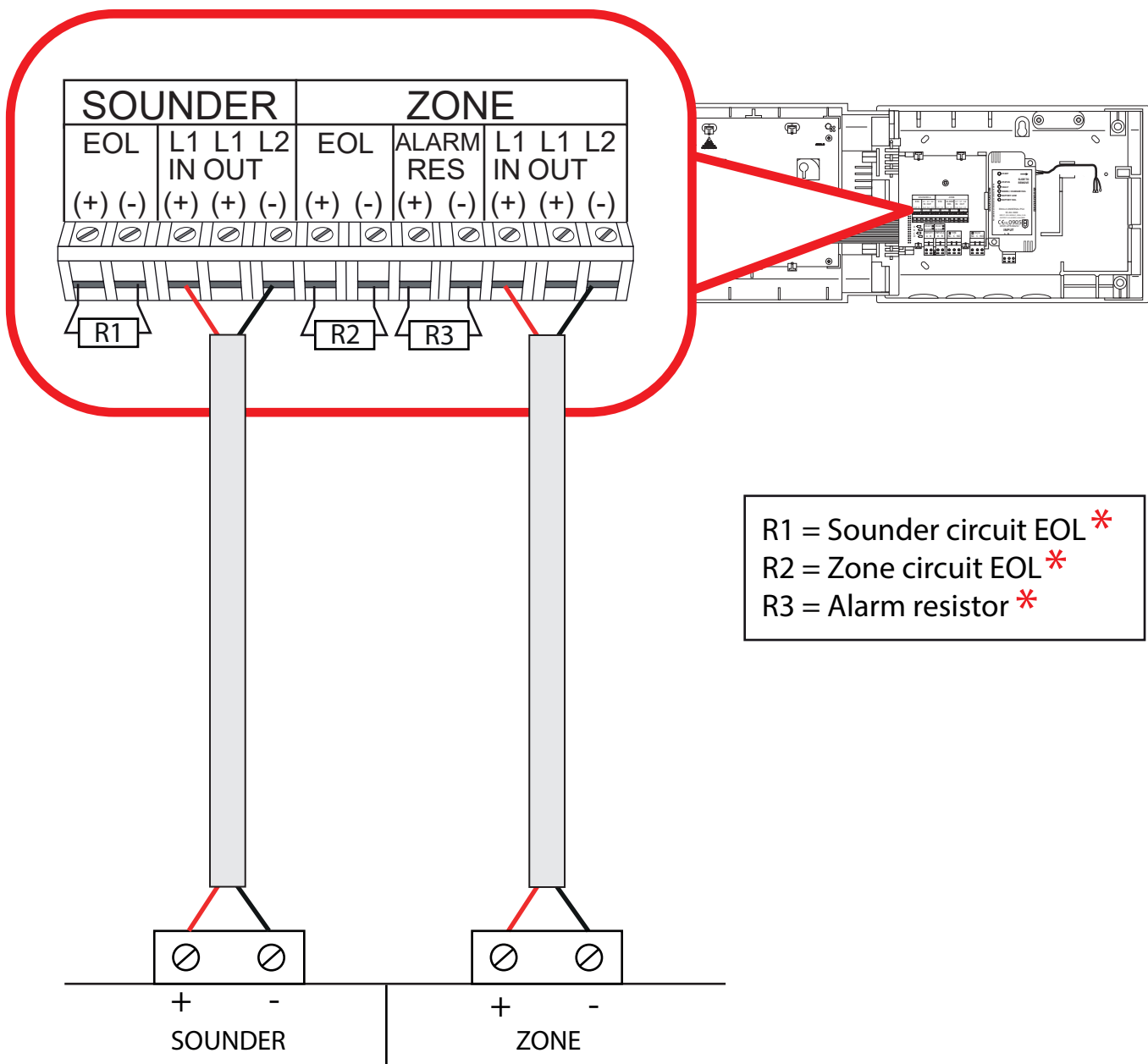

Conventional fire system connections

FOOTNOTES

- * Ensure that the manufacturer's specified end of line components and triggering resistors are fitted. See the control panel's instructions for more information.

Make mains power connections:

230 VAC WZMs only.

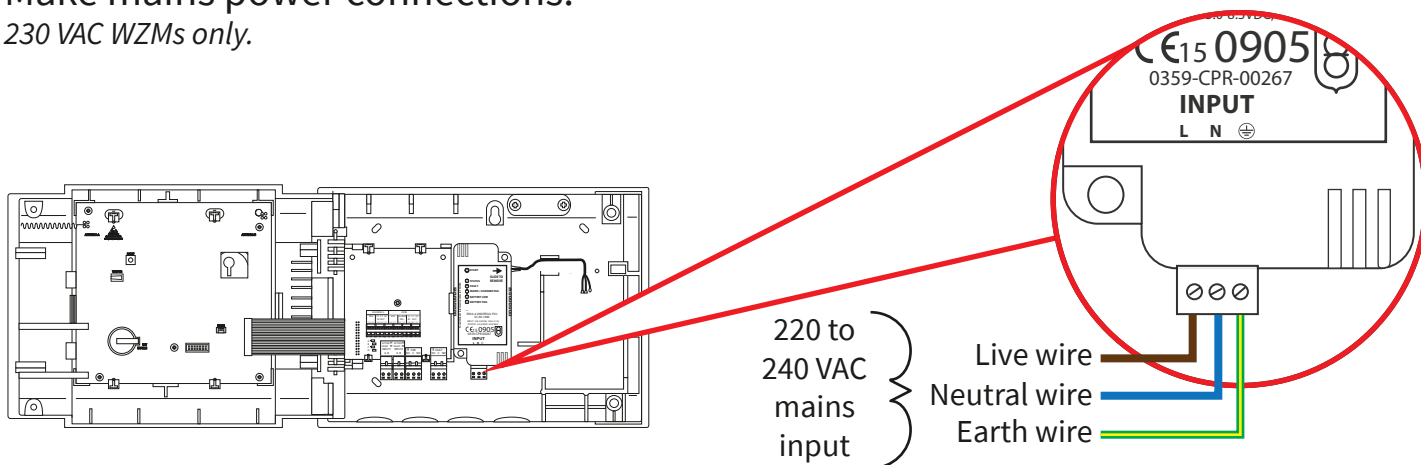

Make 24 VDC power connections:

24 VDC WZMs only.

The 24 VDC SmartCell WZM is designed to be powered from 2x 24 VDC power sources, to meet country specific requirements.

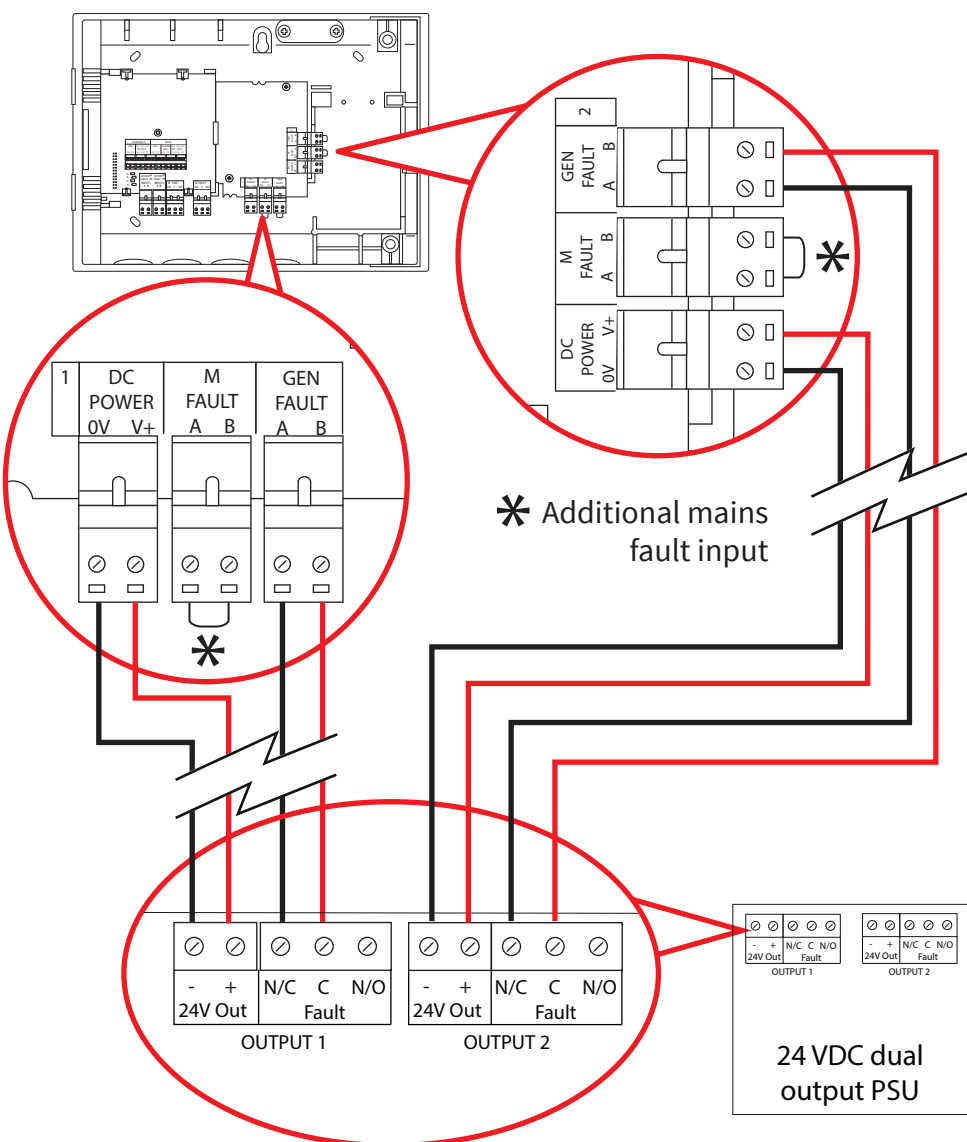

- Connect both power inputs.
- There are also general fault inputs (GEN FAULT) and mains fault (M FAULT) available.
- The fault inputs are voltage free.
- If a fault input (GEN FAULT or M FAULT) is not being used, leave the link as factory fitted.

Re-fit door

Re-connect the ribbon cable and re-fit the door hinges.

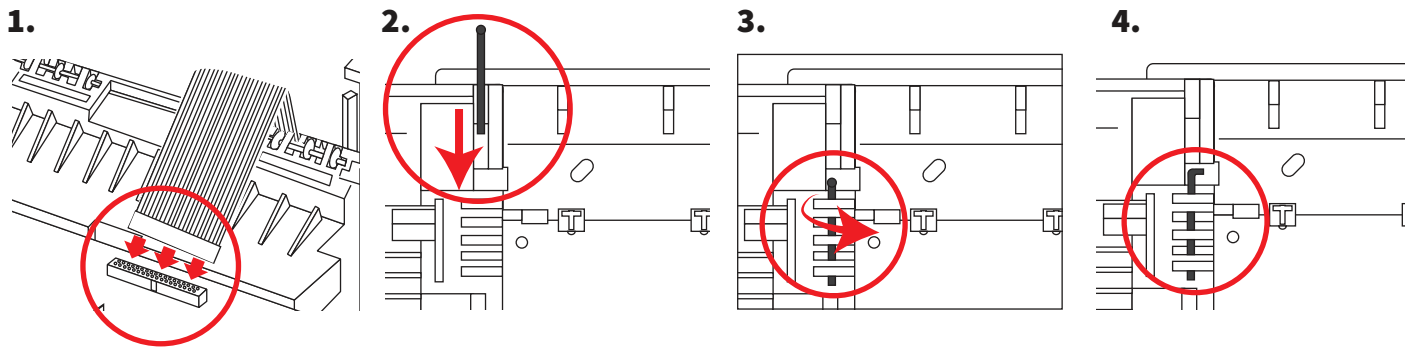

Connect backup battery

230 VAC WZMs only.



Warning
Observe battery polarity!

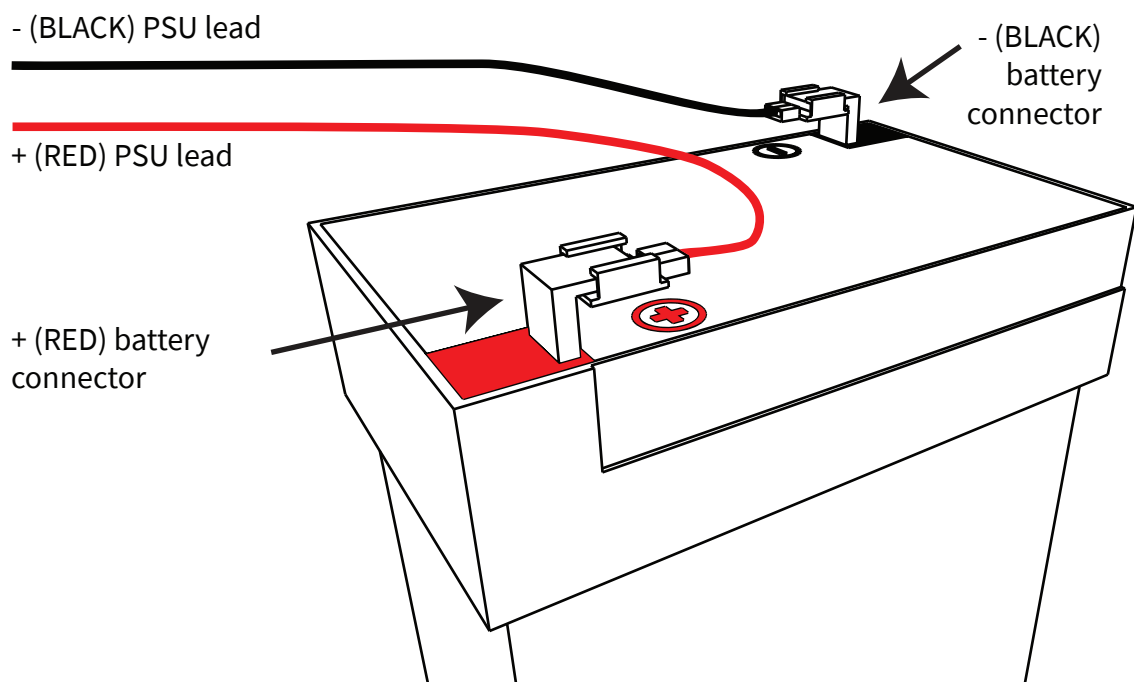

Remove 3 V battery tab.

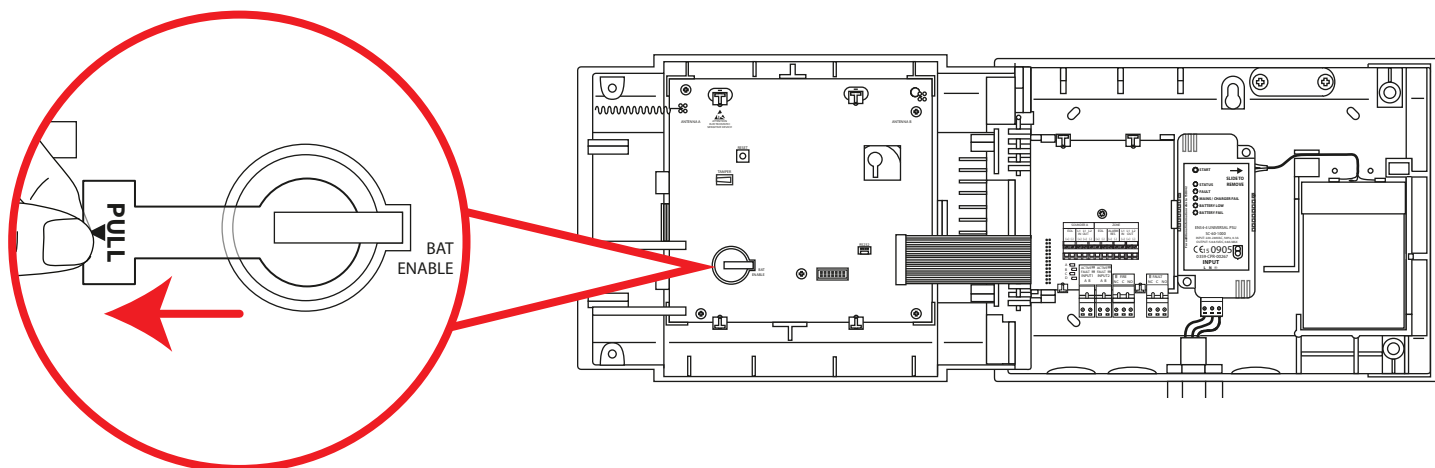

Apply power

The power supply to the WZM can now be switched on.

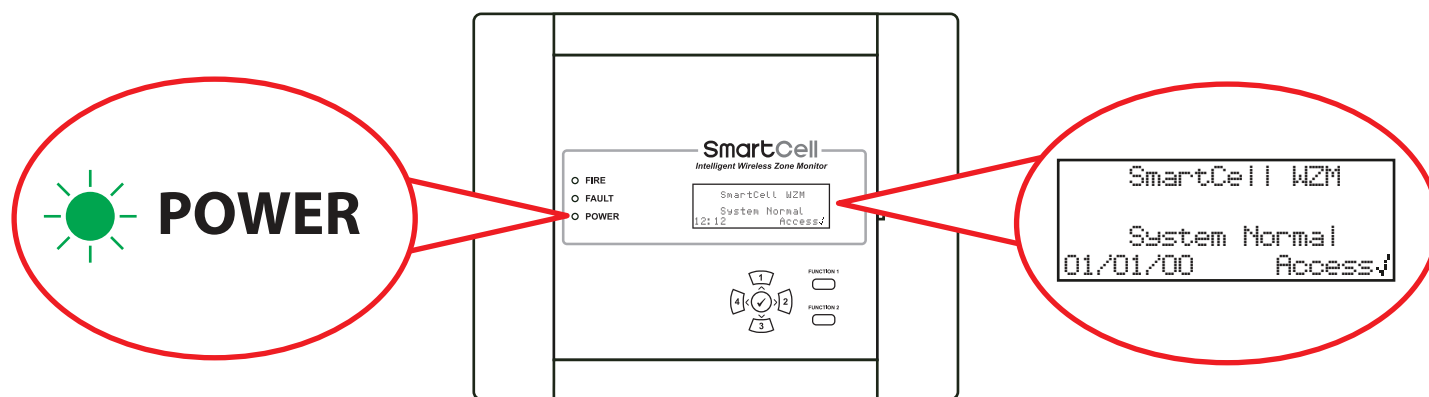

Note: If mains supply is unavailable at this point, the WZM can be temporarily powered by the back-up battery.

To achieve this, simply press the PSU's 'START' button.

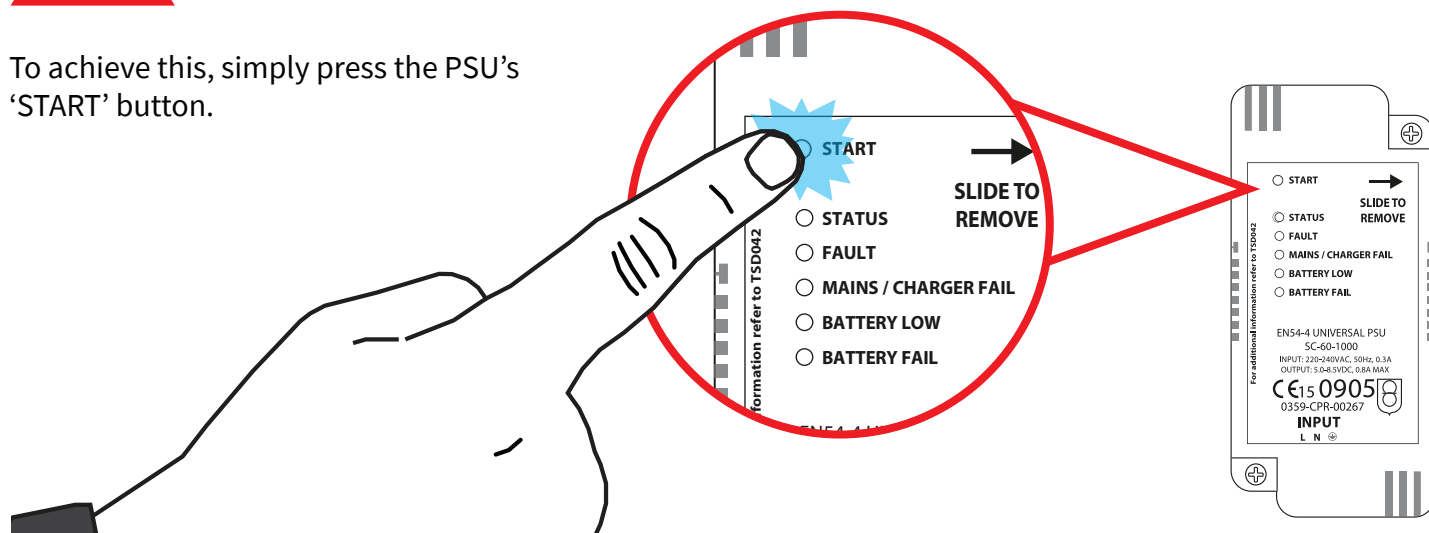

Set time & date

From access level 3 (refer to the 'Access Level 3' section for details), press the  button until the screen displays:

```

→WZM Information
  Language
  Factory Access
  Reports
  
```

Press the  button and the screen will display:

```

→Edit Users
  WZM Options
  System Options
  Communications
  
```

Press the  button once. The screen will display:

```

  Edit Users
→WZM Options
  System Options
  Communication
  
```

Press the  button and the screen will display:

```

→Set Time & Date
  Lamp Test
  Front Screen Text
  WZM LED Disable
  
```

Press the  button and the screen will display:

```

→??:??          TIME
  ??/??/??      DATE
  DD/MM/YY      FORMAT
  Press √ To Select
  
```





To change the time, press the  button and the screen will display:

```

→ ??:??          TIME

  Edit ∘    √ To Select
  
```

The following buttons are required to set the time:

Button(s)	Action
 	Increases and decreases the selected value.
 	Moves the cursor between the hour and minute selections.
	Saves the changes and returns to the previous screen.



Note: the same process is used for changing the date.

Install devices

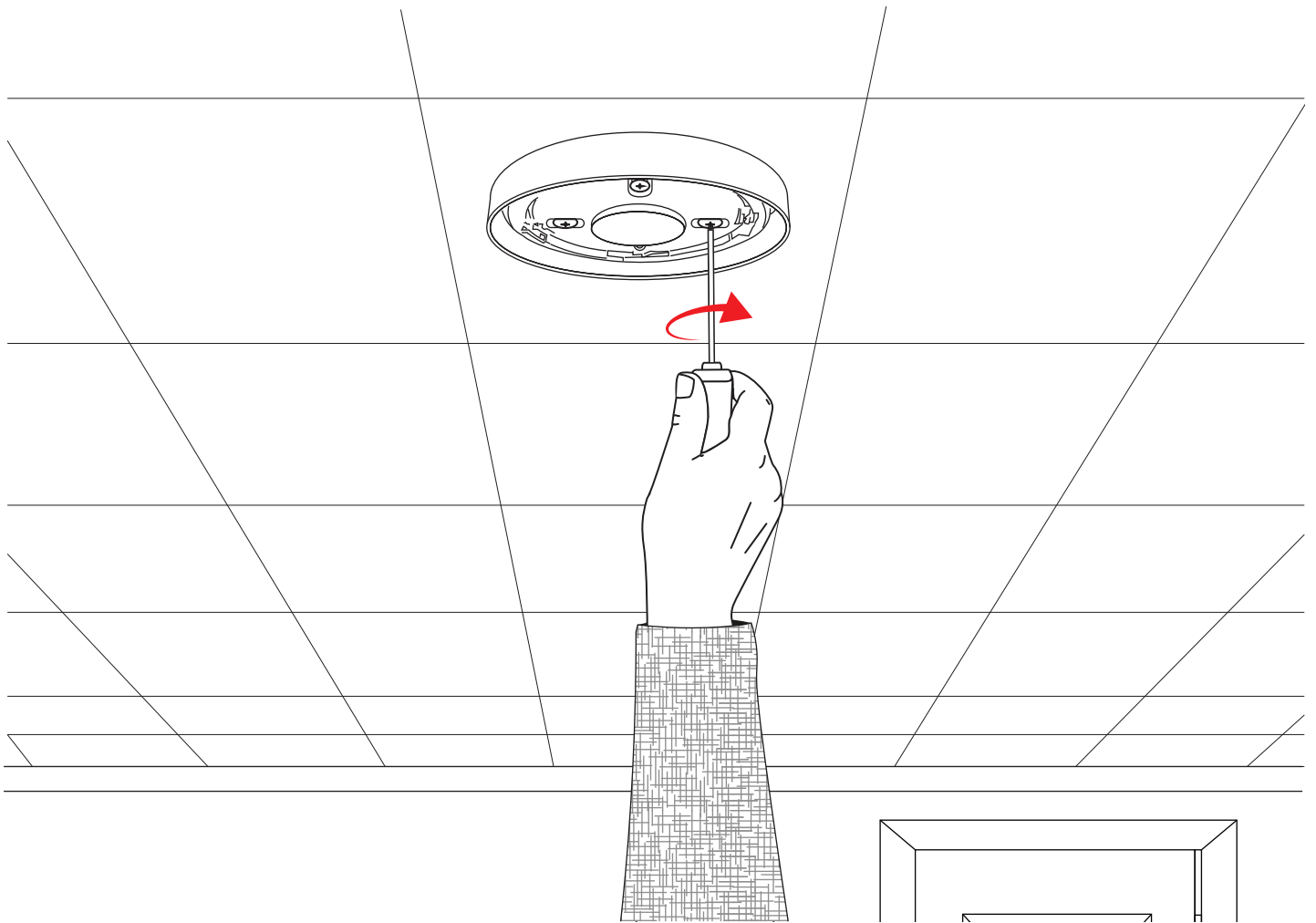

Note: Refer to the associated device installation guide for full details.

Add devices to system

From access level 3 (refer to the 'Access Level 3' section for details), press the **3** button until the screen displays:

```
View System Status
Maintenance/Test
→Device Options
WZM Settings ↕
```

Press the **✓** button and the screen will display:

```
→Add New Device
Remove Device
Edit Settings
Signal Level Text ↕
```

Press the **✓** button and the screen will display*:

```
→At WZM
At Device Location
Configure Devices ↕
```

Press the **✓** button and the screen will display:

```
Insert Batteries
Into Device
NOW
```

Insert the device's batteries and the screen will change to show:

```
FIRE Type ?
Sounder Detector
ID:001234
√Add <Exit
```

Check that the device ident on-screen matches the device ident shown on the barcode label. Press **✓** to confirm, or **4** to cancel. If accepted, the screen will display:

```
New FIRE
Device Added
ID:001234
Zone 00 Address 01
```

Followed by:
*Either continue adding new devices (by inserting batteries, or press **4** until the front screen is displayed.*

```
Add Another
Device ?

√Continue <Exit
```

* Refer to the 'WZM menus' section for alternative programming methods.

Device attributes

From access level 3 (refer to the 'Access Level 3' section for details), press the  button until the screen displays:

```
View System Status
Maintenance/Test
→Device Options
WZM Settinas ◊
```

Press the  button and the screen will display:



```
→Add New Device
Remove Device
Edit Settinas
Signal Level Text ◊
```

Press the  button until the screen displays:

```
Add New Device
Remove Device
→Edit Settinas
Signal Level Text ◊
```

Press the  button and the screen will display:

```
A01 ID:001234
Sonder Detector
ID:001234
Devices◊ Change>
```

Press the  button until the device to configure is shown. Press the  button and the screen will display:

```
A03 ID:001236
Sonder Detector
Beacon ID:001236
Devices◊ Change>
```

Press the  button and the screen will display:

```
→Text Description
Detection- Dual
Smoke Sen- Normal
Heat Sen- 58C 30
```

Available options for each device type are shown overleaf.

Menu Selection	Available options
Text Description	Refer to the 'Device location text' section overleaf for details.
Detection	Detection selection of 'Dual' (smoke & heat), 'Smoke Only' or 'Heat Only'.
Smoke Sen	Smoke sensitivity selection of; 'Normal*†' and 'Normal + AVF'. (The AVF option allows additional verification of the alarm condition before reporting).
Heat Sen	Heat sensitivity selection of; '58 °C Static*†', '58 °C Rate Of Rise*', '72 °C Static*', '72 °C Rate Of Rise*'.
Sound Volume	Allows device sounder levels of; 'High' or 'Low'.
Self Sound	When enabled, the will device sound upon local alarm detection, whilst wireless communication with the WZM is lost.
Audio/Visual 	Allows device sounder and beacon selection of; sounder & beacon, sounder only and beacon only.
O/P 1 OFF	Choose to switch the device's 'Output 1' off, when either the 'silence' or 'reset' button is pressed.
O/P 2 OFF	Choose to switch the device's 'Output 2' off, when either the 'silence' or 'reset' button is pressed.

* EN54 approved sensitivities † Default dual sensitivities

Device location text

From access level 3 (refer to the 'Access Level 3' section for details), press the  button until the screen displays:

```
View System Status
Maintenance/Test
→Device Options
WZM Settins  ◊
```

Press the  button and the screen will display:



```
→Add New Device
Remove Device
Edit Settins
Signal Level Test  ◊
```

Press the  button until the screen displays:

```
Add New Device
Remove Device
→Edit Settins
Signal Level Test  ◊
```

Press the  button and the screen will display the first device logged on to the system:

```
AO1                ID:001234
Sounder Detector
ID:001234
Devices◊          Change>
```

Press the  button to scroll through the devices until the required device is shown. Press the  button:

Press the  button and the screen will display:

```
→Text Description
Detection-        Dual
Smoke Sen-        Normal
Heat Sen-         58C 5◊
```

Press the  button and the screen will display:









```
■Dual Detector
ID:001234

F1 ABC  F2 Delete
```

Refer to the 'Text entry' section overleaf.

Text entry

The following buttons will be required to enter new text descriptions:

Button	Action
	Moves the selected character through the alphabet (forwards), one character at a time.
	Moves the selected character through the alphabet (backwards), one character at a time.
	Moves the cursor (selected character) left, one character at a time.
	Moves the cursor (selected character) right, one character at a time.
FUNCTION 1 	Used to toggle character entry format between; upper case, lower case and number.
FUNCTION 2 	Provides a delete function; press for single character deletion, or press and hold to delete all text.
	Exits from the current screen. The user is asked whether to save the changes ( button for yes and  button for no).

Set the panel type

Default panel type is 'Conventional'. If the WZM is to be connected to a conventional type fire panel, skip this section. Otherwise, to change the panel type to 'Addressable', from access level 3 (refer to the 'Access level 3' section for details), press the  button until the screen displays:

Press the  button and the screen will display:

Press the  button and the screen will display:

Press the  button and the screen will display:

Press the  button and the screen will display:

```
View System Status
Maintenance/Test
Device Options
→WZM Settings
```

```
→Panel Type
Sounder Options
Device Indicator
```

```
→Conventional ✓
Addressable
```

```
Conventional ✓
→Addressable
```

```
→Addressable Panel
Selected
```

Sounder tones

To change the fire tone, from access level 3 (refer to the 'Access level 3' section for details), press the

 button until the screen displays:

```
View System Status
Maintenance/Test
Device Options
+WZM Settings
```

Press the  button and the screen will display:

```
+Panel Type
Sounder Options
Device Indicator
```

Press the  button until the screen displays:

```
Panel Type
+Sounder Options
Device Indicator
```

Press the  button and the screen will display:



```
+Default Tone Select
Sounder Duration
Sounder Activation
Pulsed Output
```

Press the  button and the screen will display:

```
+Fire Tone - 05
```

Press the  button and the screen will display :

```
970Hz - 630Hz, @1Hz
  7 7 7 7 7
05
Tone 0 / To Select
```

Press the  and  buttons to view the available tones and press the  button to select the required tone:

```
800Hz - 970Hz, @1Hz
  1 1 1 1 1
03
Tone 0 / To Select
```

Sounder duration

As default, wireless sounders automatically switch off after 30 minutes, to conserve battery life. Sounders can also be configured for continuous uninterrupted operation, until switched off by the control panel.

If the sounder duration is to be changed to continuous operation, from access level 3 (refer to the 'Access level 3' section for details), press the  button until the screen displays:

Press the  button and the screen will display:

Press the  button until the screen will displays:

Press the  button and the screen will display:

Press the  button until the screen will displays:

Press the  button and the screen will display:

Press the  button until the screen will displays:

Press the  button and the screen will display:

```
View System Status
Maintenance/Test
Device Options
→WZM Settings
```

```
→Panel Type
Sounder Options
Device Indicator
```

```
Panel Type
→Sounder Options
Device Indicator
```

```
→Default Tone Select
Sounder Duration
Sounder Activation
Pulsed Output
```

```
Default Tone Select
→Sounder Duration
Sounder Activation
Pulsed Output
```

```
→30 Mins Auto Off ✓
Continuous
```

```
30 Mins Auto Off ✓
→Continuous
```

```
Sounder Duration
Set To
Continuous
```

Sounder activation method

As default, wireless sounders will only operate upon activation of the WZM's fire input. This however can be changed to 'immediate mode', so that sounders also operate upon the activation of one of the WZM's wireless devices.

If the sounder activation method is to be changed to immediate mode, from access level 3 (refer to the 'Access level 3' section for details), press the  button until the screen displays:

Press the  button and the screen will display:

Press the  button until the screen will displays:

Press the  button and the screen will display:

Press the  button until the screen will displays:

Press the  button and the screen will display:

Press the  button until the screen will displays:

Press the  button and the screen will display:

```
View System Status
Maintenance/Test
Device Options
+WZM Settings
```

```
+Panel Type
Sounder Options
Device Indicator
```

```
Panel Type
+Sounder Options
Device Indicator
```

```
+Default Tone Select
Sounder Duration
Sounder Activation
Pulsed Output
```

```
Default Tone Select
Sounder Duration
+Sounder Activation
Pulsed Output
```

```
+Panel Mode
Immediate Mode
```

```
Panel Mode
+Immediate Mode
```

```
Sounder Activation
Set To
Immediate Mode
```

Pulsed output

As default, the pulsed output, for the fire and the fault relays, is set to latched. Upon an activation, the relay will remain latched in alarm until the WZM is reset. This however can be changed to pulse into alarm for a pre-defined period of time, before automatically clearing. Permitted times range from 5-60 seconds.

If the pulsed out is to be changed, from access level 3 (refer to the 'Access level 3' section for details), press the  button until the screen displays:

Press the  button and the screen will display:

```
View System Status
Maintenance/Test
Device Options
→WZM Settings
```

Press the  button until the screen will displays:

```
→Panel Type
Sounder Options
Device Indicator
```

Press the  button and the screen will display:



```
Panel Type
→Sounder Options
Device Indicator
```

Press the  button until the screen will displays:

```
→Default Tone Select
Sounder Duration
Sounder Activation
Pulsed Output
```

Press the  button and the screen will display:

```
Default Tone Select
Sounder Duration
Sounder Activation
→Pulsed Output
```

Press the  and  buttons, until the screen displays the required relay type:

In this example, the fault relay has been chosen.



```
→Fire Relay- LATCH
Fault Relay- LATCH
```

Press the  button and the screen will display:

```
Fire Relay- LATCH
→Fault Relay- LATCH
```

```
Fault Relay

00 LATCH
Secs 0 / To Select
```

Press the  and  buttons, until the required time is displayed:

In this example, 20 seconds has been chosen.

Press the  button and the screen will display:

Note: the same options are available for the fire and fault relays.

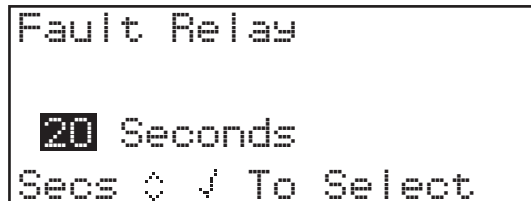

```
Fault Relay
20 Seconds
Secs 0 1 To Select
```

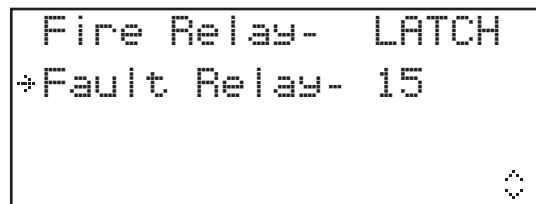

```
Fire Relay- LATCH
>Fault Relay- 15
◇
```

Device indicator operation

This feature is only available when the 'Panel Type' is set to 'Addressable'. As default, the device LED indicators are switched 'Off When Silenced' (upon receipt of a silence command signal from the control panel). Alternatively 'Off When Reset' can be selected (where the device LED indicators switch off upon the receipt of a reset command signal from the control panel).

If the indicators are to be switched 'Off When Reset', from access level 3 (refer to the 'Access level 3' section for details), press the  button until the screen displays:

```
View System Status
Maintenance/Test
Device Options
→WZM Settings
```

Press the  button and the screen will display:

```
→Panel Type
Sounder Options
Device Indicator
```

Press the  button until the screen will displays:

```
Panel Type
Sounder Options
→Device Indicator
```

Press the  button and the screen will display:

```
→Off When Silenced ✓
Off When Reset
```

Press the  button until the screen will displays:

```
Off When Silenced ✓
→Off When Reset
```

Press the  button and the screen will display:

```
Fire Status
Turned Off
When Reset
```

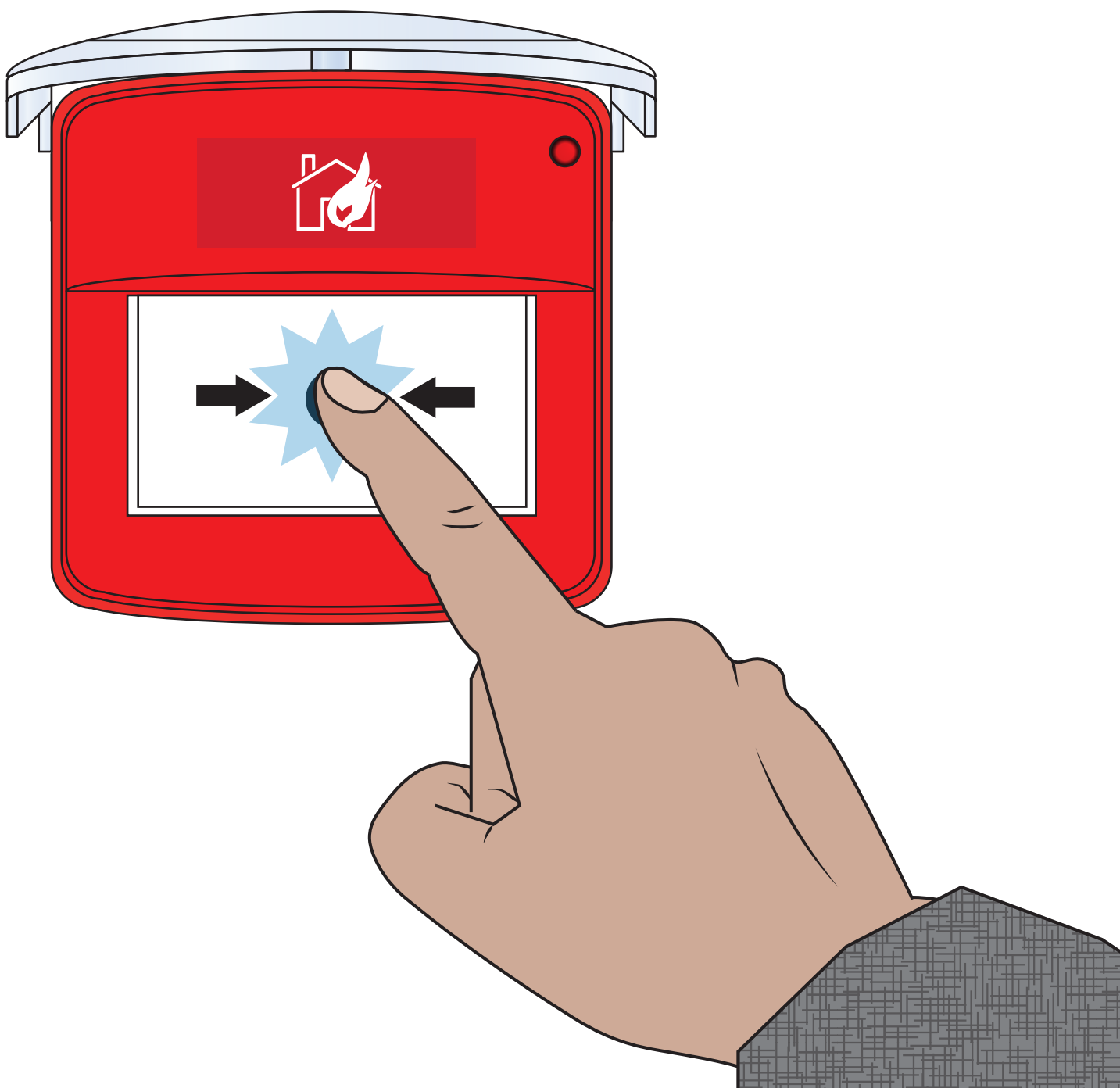

System testing



This section shows how to test the systems devices along with checking device signal and battery levels to ensure they are operating within the correct parameters. This section can be used as a guide. Local fire alarm maintenance procedures should be followed to comply with the relevant standards.

Test devices

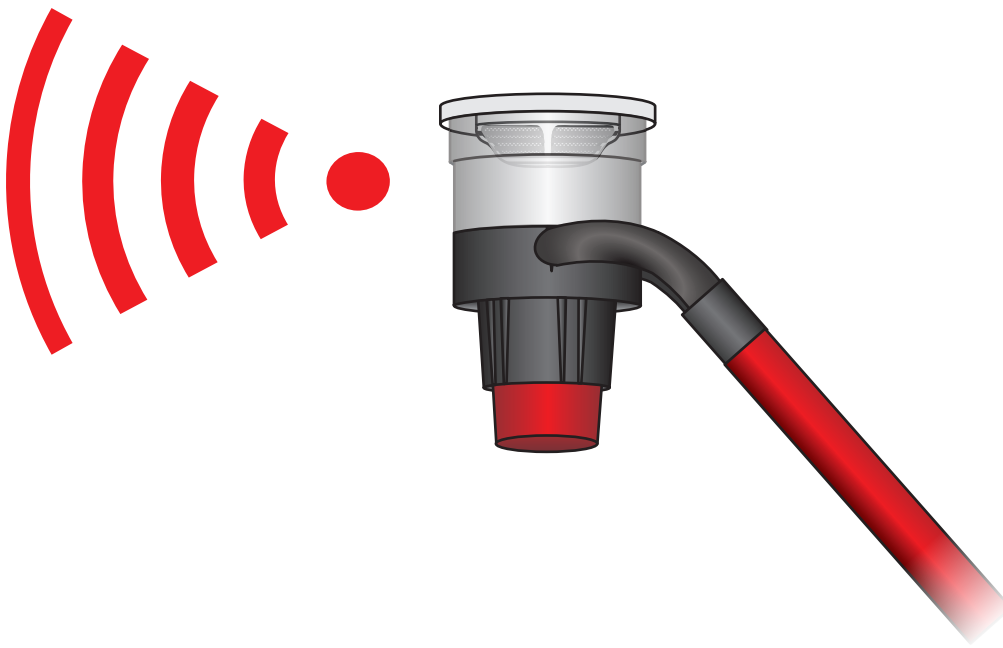
Every device should be function tested, to ensure correct functionality.



Smoke detectors should be tested using a smoke detector tester and in accordance with local codes of practice.

Heat detectors should be tested using a heat detector tester and in accordance with local codes of practice.

Call Points should be tested in accordance with local codes of practice.

Sounder operation should also be tested in accordance with local codes of practice.

Input / Output devices should also be tested in conjunction with associated 3rd party equipment and in accordance with local codes of practice.

Device signal levels

From access level 3 (refer to the 'Access Level 3' section for details), press the  button until the screen displays:

```
View System Status
→Maintenance/Test
Device Options
WZM Settings
```

Press the  button and the screen will display:

```
→Device Alarm Test
Sounder.O/P Test
Device Signal List
Device Battery List
```

Press the  button until the screen displays:

```
Device Alarm Test
Sounder.O/P Test
→Device Signal List
Device Battery List
```

Press the  button and the screen will display:

```
→Good Signal      08
Low Signal        00
No Signal         00
◇
```

Pressing the  button will provide more information on the category highlighted:

```
AD8      80dB
Dual Detector
First Floor Landline
GOOD Signal  ◇
```



Note: It is important that all devices have 'GOOD' signal levels to ensure the maximum robustness of wireless signalling.

If a device does not achieve a good signal level, refer to the 'How to improve device signal levels' section for additional guidance.

Device battery levels

From access level 3 (refer to the 'Access Level 3' section for details), press the  button until the screen displays:

```
View System Status
→Maintenance/Test
Device Options
WZM Settings
```

Press the  button and the screen will display:

```
→Device Alarm Test
Sounder.O/P Test
Device Signal List
Device Battery List
```

Press the  button until the screen displays:

```
Device Alarm Test
Sounder.O/P Test
Device Signal List
→Device Battery List
```

Press the  button and the screen will display:

```
→Battery Ok          10
Battery Low          01
Battery Missing     01
More>
```

To view individual devices within specific battery level categories, press the  button, whilst the arrow (→) is adjacent to the category to be viewed. Example displays for a device in each category are shown:

```
Z01 A20
Dual Detector
First Floor Landings
BATTERY OK  ↕
```

```
Z01 A25
Dual Detector
Basement Area
BATTERY LOW  ↕
```

```
Z01 A22
Dual Detector
Reception
BATT MISSING  ↕
```

Diagnostics

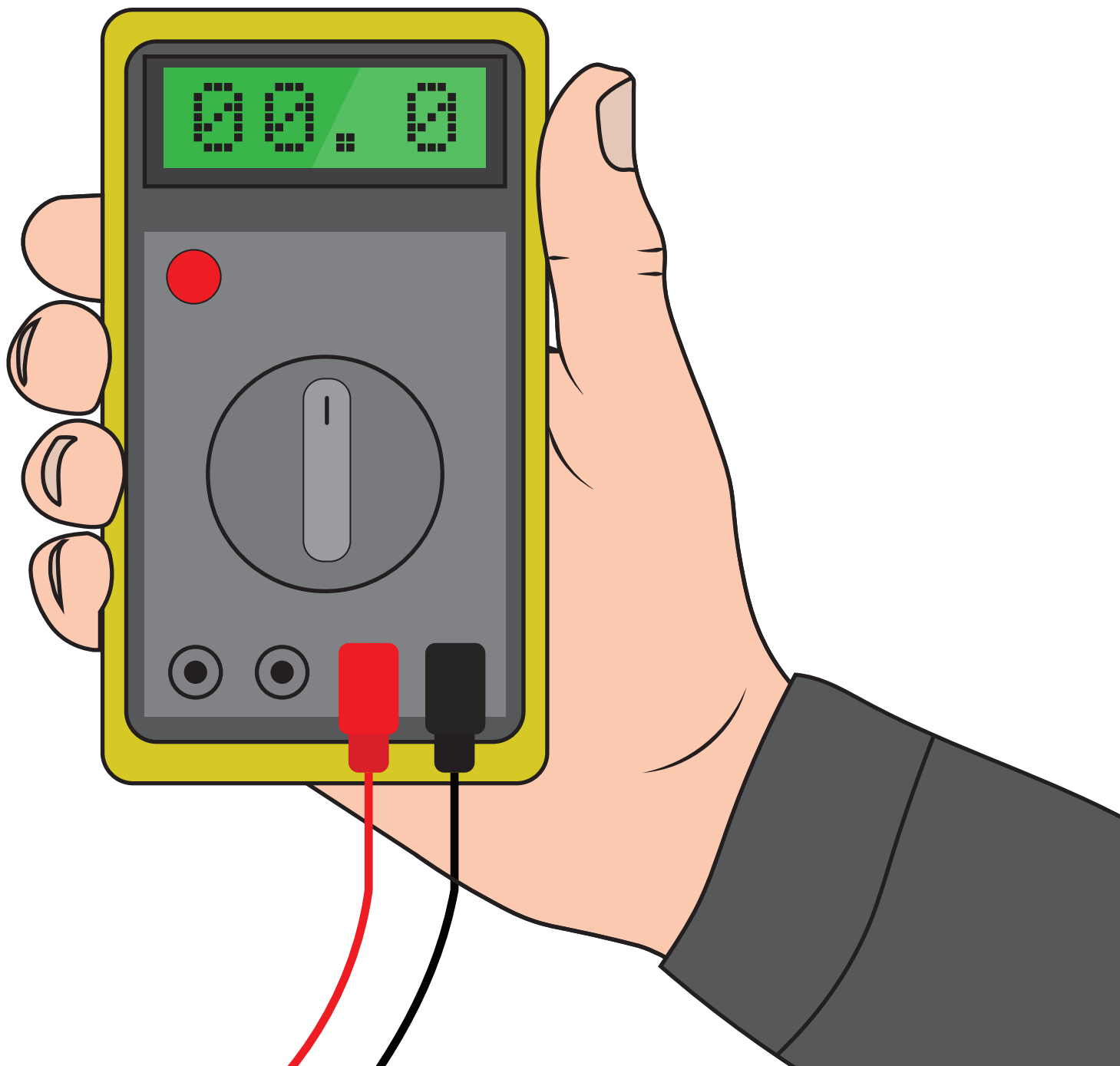













Fault rectification

Device type	Fault displayed	Rectification process
All device types	Battery Missing	Check all batteries are inserted correctly. Check voltage on batteries. Replace batteries if necessary or re-insert correctly.
WZM	Mains Fail	Check the mains supply to the unit.
Detector	Head Fault	It is recommended that the detection device be replaced due to a fault with the head being reported.
Detector	Head Dirty	Clean with compressed air if necessary, as the device is reporting that the chamber is dirty. Check the device is in a clean environment and is free from smoke, dust and dirt.
All device types	Tamper	Check the device is assembled correctly.
Input/output	Open Circuit / Short Circuit	Check the 20 k Ω end of line resistor is in place and that connections are secure.
All device types	Radio signal strength No Signal Fault	Check the devices location to ensure no visible cause can be seen. Check that the device is still powered and has been added to the system. (See the 'How to improve device signal levels' section for more information).
All device types	Battery Low	Replace all device batteries with specified batteries - see the associated device installation guide and replace within 30 days.
WZM	Battery Supply Failure	Check the integrity of the battery and it's connection.
All device types	Low signal	Note: no fault will be indicated as communication is still taking place, albeit at a low signal level. Check the device's location to ensure there is no obvious cause. (See the 'How to improve device signal levels' section for more information).
All device types	Good signal	No action required.
Call point	Fire	Check the device's resettable element is correctly in place and that the yellow area is not being displayed. If shown, reset the device using the reset key.
Detector	Fire	Ensure that the environment in the device's location is free of smoke, residue and dust.













Signal level requirements

To ensure the signal levels for each device are at an acceptable level, the 'Device Signal List' menu should be checked. This menu will display the signal level in two formats. The first format is a system overview that will detail how many devices have a 'GOOD' or 'LOW' signal, or have 'NO SIGNAL'. This can be used as a guide, so if you have a system with ten devices and the overview shows ten 'GOOD' signal levels, then there is no need to view the devices individually. The second format allows you to view each individual device. A pictorial representation coupled with signal level text, is displayed for each device on the system. This is listed in address number order. If any devices are under the signal level requirements, check the 'How to improve device signal levels' section for guidance.

An example system with all devices showing acceptable signal levels is shown below:

Wireless system setup	Device number	Shown on menu display	Acceptable level
Dual detector	Device 01	Z1 A01 GOOD 	✓
Dual detector	Device 02	Z1 A02 GOOD 	✓
Dual detector	Device 03	Z1 A03 GOOD 	✓
Manual call point	Device 04	Z1 A04 GOOD 	✓
Dual detector/ sounder	Device 05	Z2 A05 GOOD 	✓
Dual detector/ sounder	Device 06	Z2 A06 GOOD 	✓
Dual detector/ sounder	Device 07	Z3 A07 GOOD 	✓
Manual call point	Device 08	Z4 A08 GOOD 	✓
Manual call point	Device 09	Z4 A09 GOOD 	✓
Dual detector	Device 10	Z4 A10 GOOD 	✓
Dual detector	Device 11	Z4 A11 GOOD 	✓
Dual detector/ sounder beacon	Device 12	Z4 A12 GOOD 	✓
Sounder	Device 13	Z4 A13 GOOD 	✓

An example system with devices showing both acceptable and unacceptable signal levels is shown below:

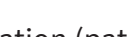
Wireless system setup	Device Number	Shown on Menu Display	Acceptable Level
Dual detector	Device 01	Z1 A01 NO SIGNAL 	✗
Dual detector	Device 02	Z1 A02 LOW 	✗
Dual detector	Device 03	Z1 A03 GOOD 	✓
Manual call point	Device 04	Z1 A04 GOOD 	✓
Dual detector/ sounder	Device 05	Z2 A05 LOW 	✗
Dual detector/ sounder	Device 06	Z2 A06 LOW 	✗
Dual detector/ sounder	Device 07	Z3 A07 GOOD 	✓
Manual call point	Device 08	Z4 A08 NO SIGNAL 	✗
Manual call point	Device 09	Z4 A09 GOOD 	✓
Dual detector	Device 10	Z4 A10 GOOD 	✓
Dual detector	Device 11	Z4 A11 GOOD 	✓
Dual detector/ sounder beacon	Device 12	Z4 A12 GOOD 	✓
Sounder	Device 13	Z4 A13 GOOD 	✓

Meeting the acceptable signal levels shown ensures immunity to site attenuation (path loss) is met, as required in clause 4.2.1 and annexe B of EN54-25.

How to improve device signal levels

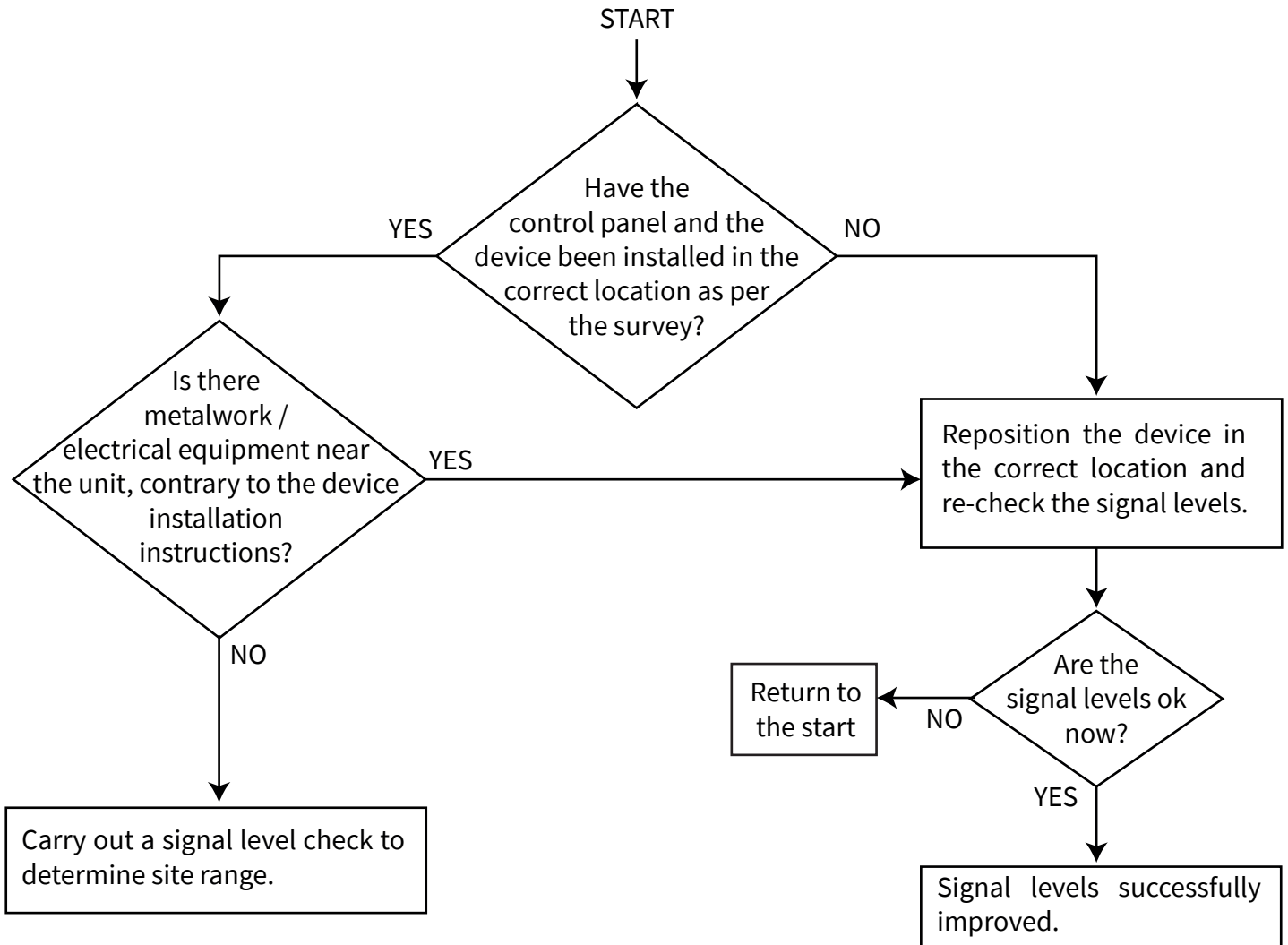

WZM menus

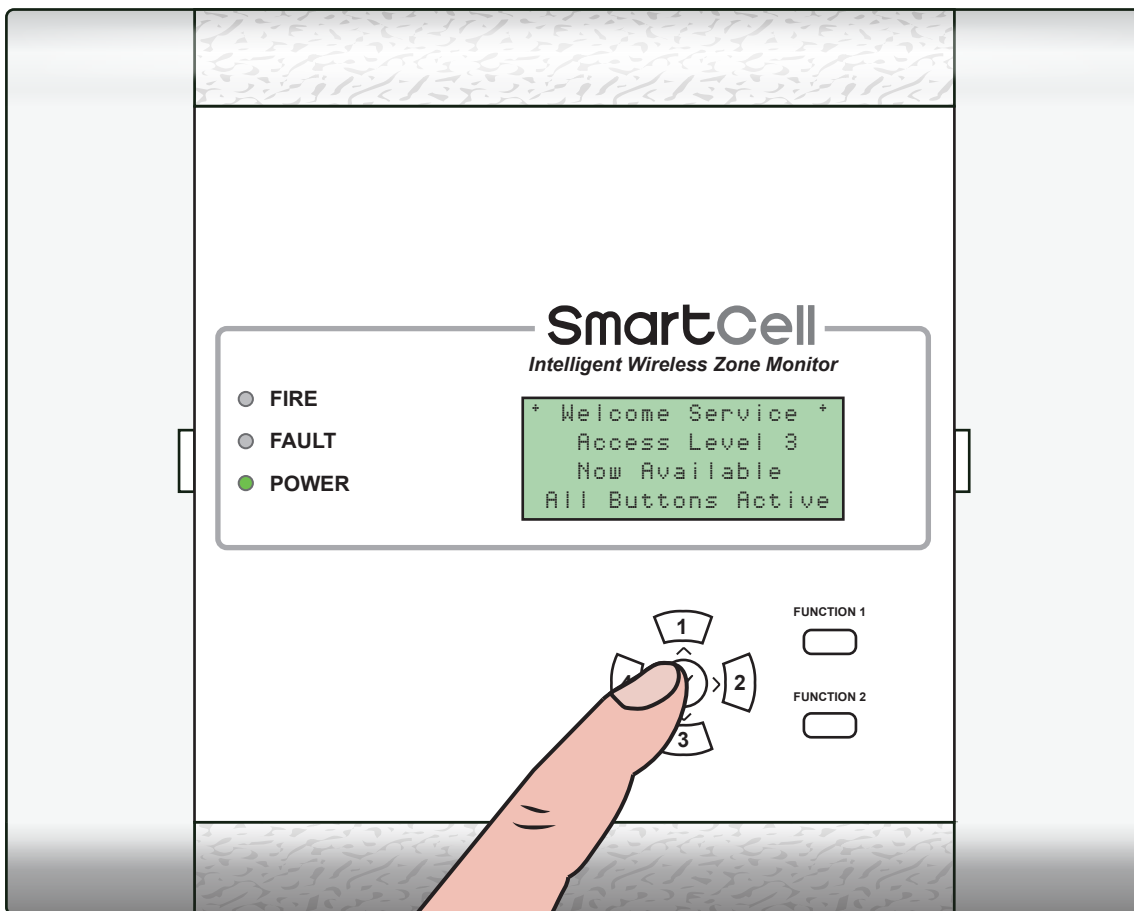

Access level 3 tree view

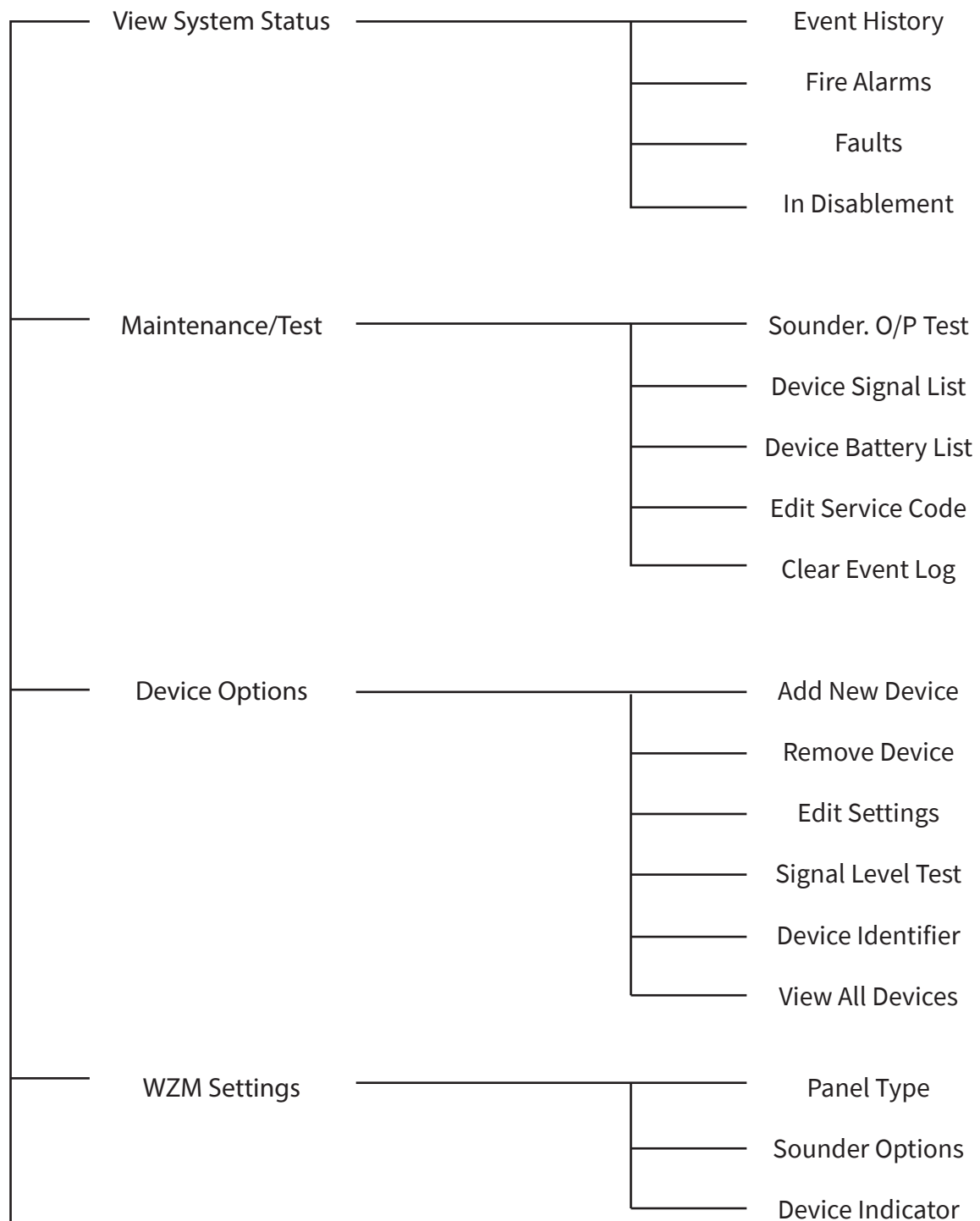

Continued overleaf...

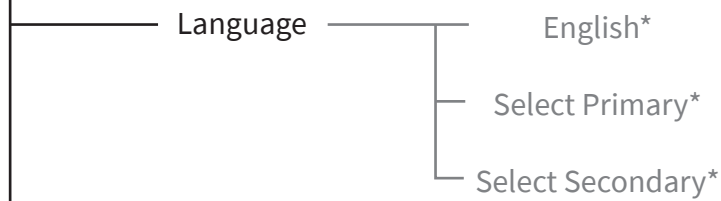
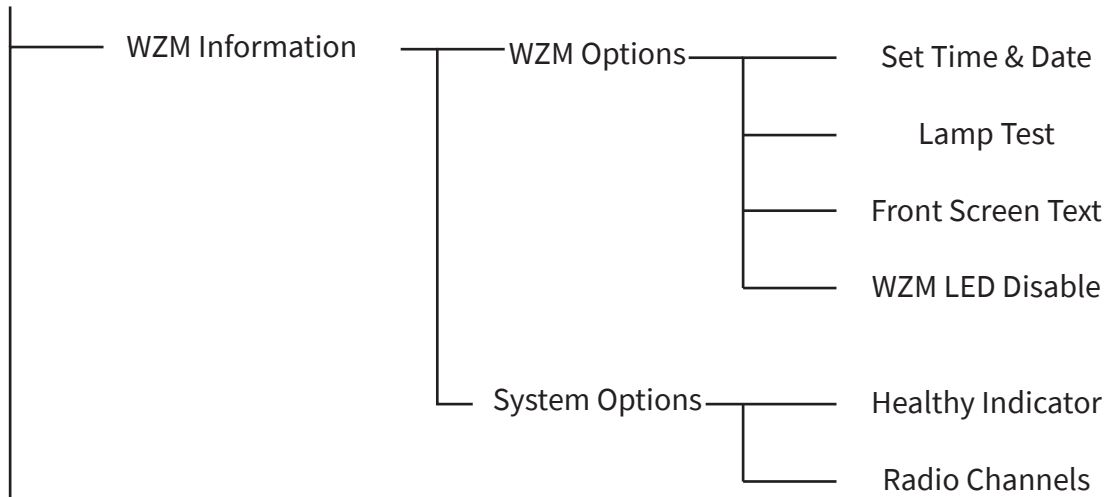

**This feature is not currently supported in this version of software*

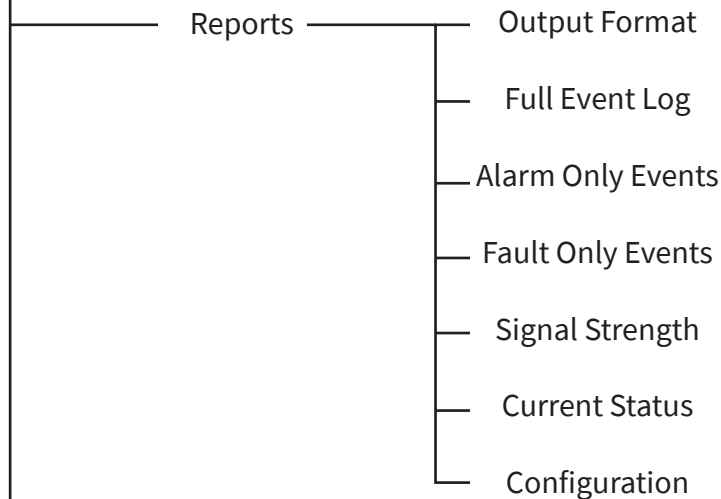
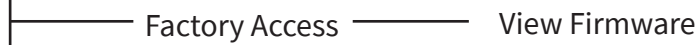

Continued overleaf..

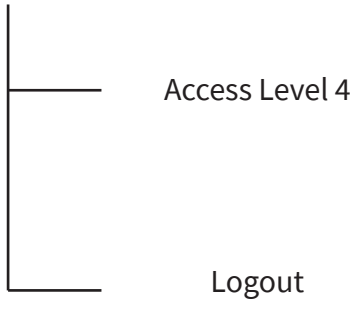



Access level 3 menu options

View system status

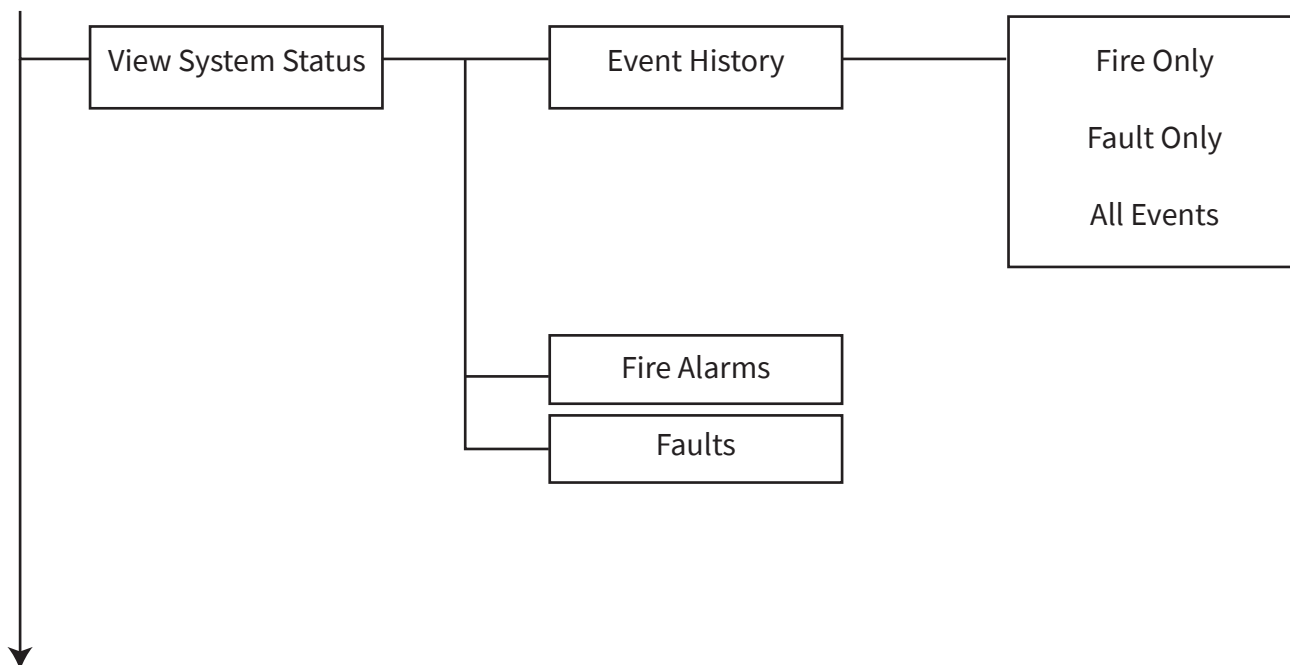
The view system status menu allows the engineer to view the historical event log, along with viewing the status of individual devices on the system and current disablements/test states. This menu option is shown in detail below:





Event history

When entered, options are available to view filtered 'Fire', or 'Information' events only or alternatively, 'All Events' can be viewed. A total number of events for each option is also indicated. When the event option is entered, the display will show the latest event first. The events can then be scrolled through by using the  and  buttons. Each log entry records the event type, the device's zone (at the time of the event), the device address (text description if allocated) and time and date at which the event occurred. The event log is a scrolling log, shown in chronological order and will automatically overwrite the oldest events when the 1000 event capacity is reached. The log can however be cleared using an access level 3 code and entering the relevant menu if required. Note: the default access level 3 code is 333333.



The example below shows a historical event, logged for a 'TAMPER' fault on a device.

Device address	A20	TAMPER	Event type
Device's text description	Dual Detector	First Floor Landings	
Time & date of the event	12:05 10/01/23		



Fire only

This menu displays the total number of fire alarms that are currently on the system. The total number is shown next to the fire alarm text. Pressing the  button details the individual devices in fire alarm. The devices in fire alarm condition can then be scrolled through, using the  and  buttons.

Fault only

This menu displays the total number of faults that are currently on the system. The total number is shown next to the fault text. Pressing the  button will show individual devices in a fault condition. The devices which can be either information or fire devices can be scrolled through, using the  and  buttons. A fault description will be associated with any devices.

All events

This menu displays the total number of devices on the system. When entered, the individual device details along with it's current status are shown. The device list starts at the lowest address fire and these can be scrolled through, using the  and  buttons. When all of the fire devices have been scrolled through, the list will subsequently show all of the information devices, again in address number order.

Maintenance/test

This menu option enables the engineer to test devices and to view their test statuses. Additionally, in this menu, individual sounders can be tested and device signal and battery levels can be viewed.

This menu option is fully shown and detailed below:

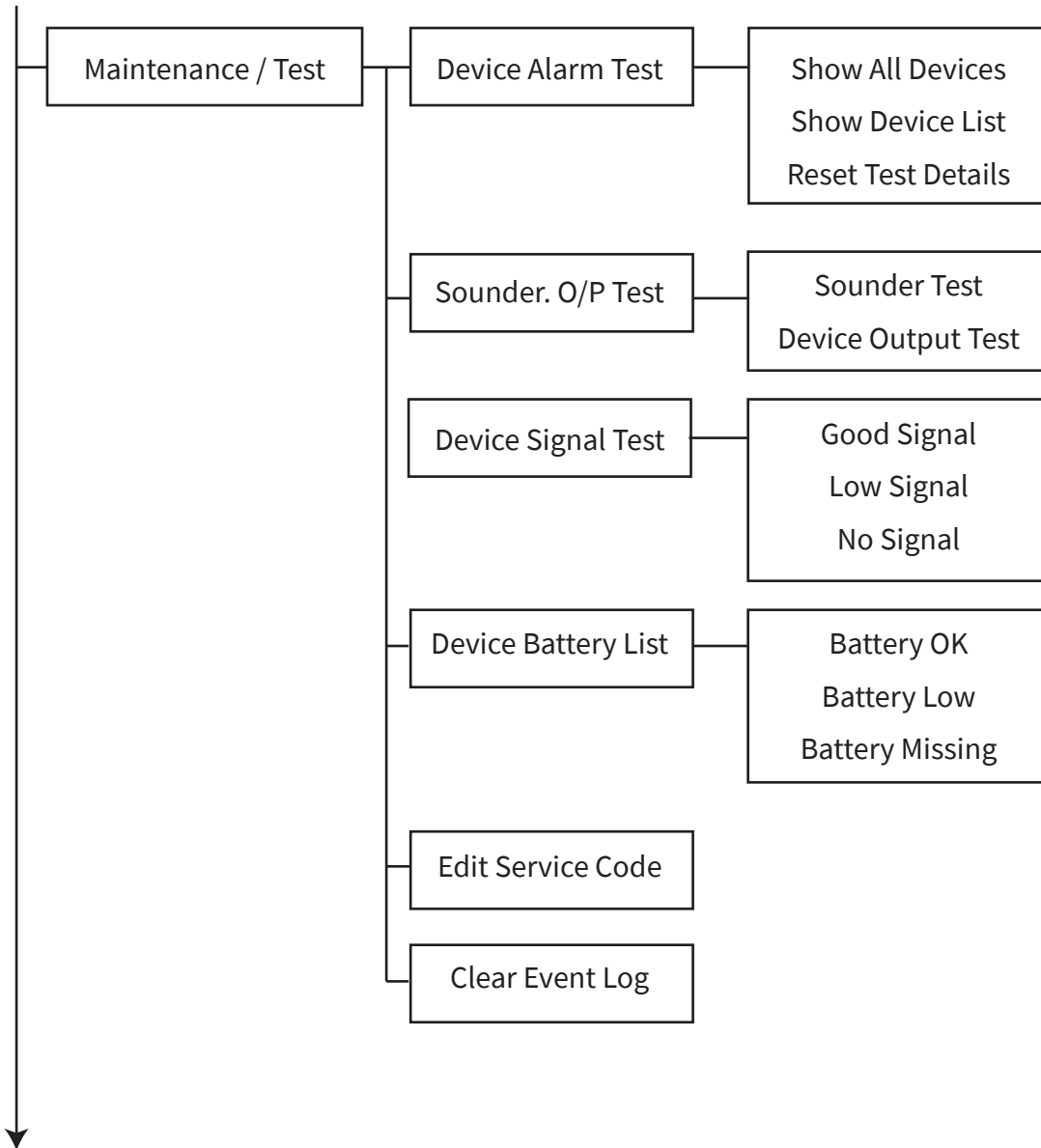



Sounder O/P Test



This menu option allows the engineer to send individual sounder devices a command to switch its sounder elements on and off. Individual output devices can also be selected to turn the units relay outputs on and off.

Note: If the unit is a dual output device, both outputs will operate.

Device Signal List

This menu option allows the engineer to view signal information for all devices on the system. You can scroll through the list using the  and  buttons. The signal levels will be shown as GOOD, LOW and NO SIGNAL.

Device Battery List

This menu option allows the engineer to view battery information for all devices on the system. You can scroll through the list using the  and  buttons. The battery levels will be displayed for each device using BATTERY OK, BATTERY LOW and BATTERY MISSING icons.

Edit Service Code

This menu option allows the engineer to change the four digit service code, that is required for entry to access level 3.

Clear event log

This menu option allows the event log to be cleared.

Device options

This menu allows the engineer to add, remove and replace devices. The user can also edit the devices programming parameters, view device information and identification modes of test operation.

This menu option is fully shown and detailed below:-

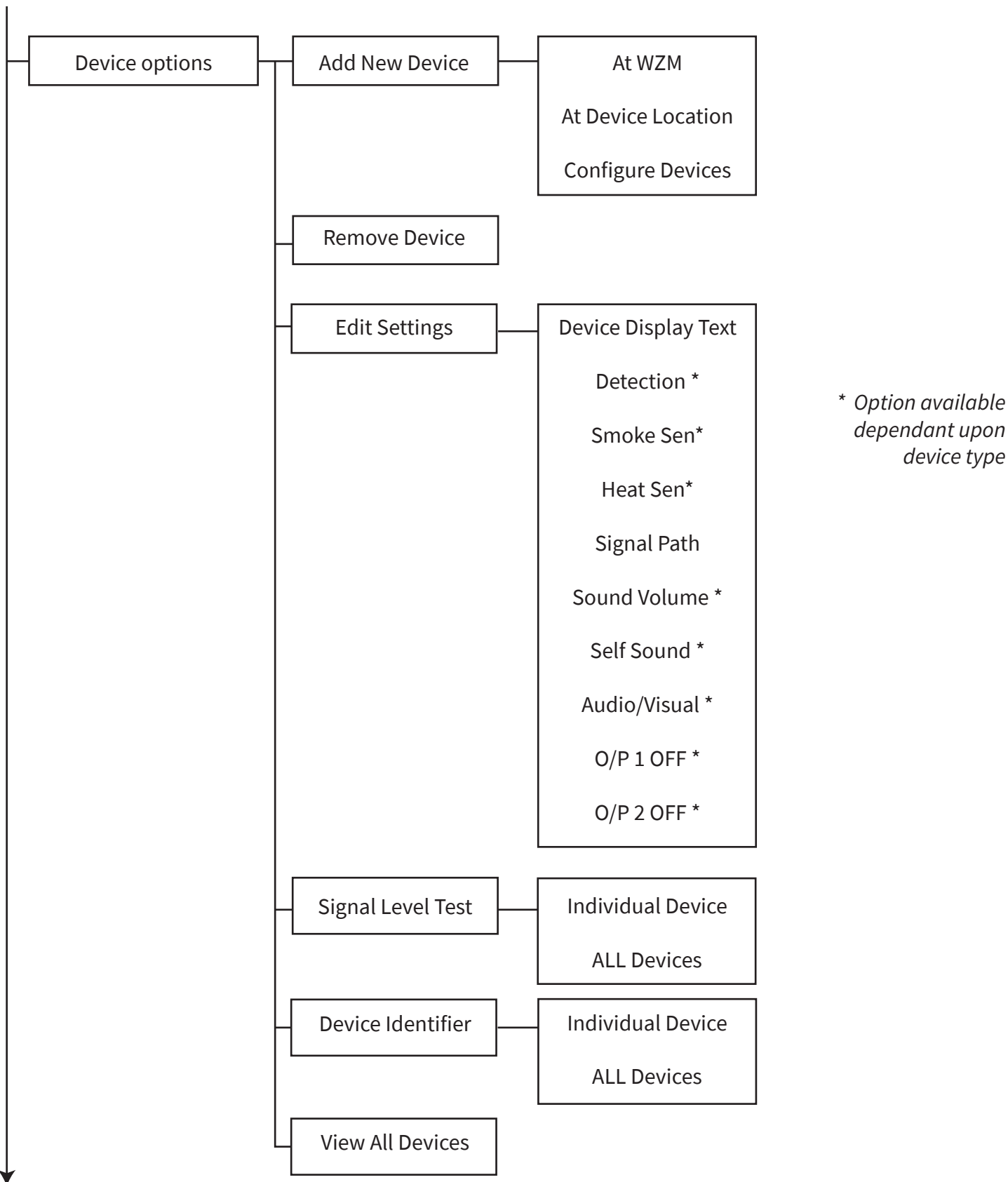

Add new device

This menu allows all wireless device types to be added to the system. The function allows the device to be added in two different ways. Both methods are shown in more detail below:-

At WZM

This option is used when devices are logged onto the system prior to the devices being installed. The step by step process is shown below:



- A) Log on /adding is undertaken whilst standing in front of the WZM with each device.
- B) This involves entering the 'Add WZM' menu, then fit the device's batteries.
- C) The device details are then received and displayed on the WZM.
- D) Check the device ident number shown on screen against the ident shown on the device's barcode label. If correct and details are accepted, the device is added to the control panel.
- E) The device can then be installed in the required location.

Add Device Location

This option is usually used when the devices have already been installed and the user requires them to be added to the system via the devices magnetic log on switch. The step by step process is shown below:

- A) Log on /adding is undertaken by visiting each installed device.
- B) This involves entering the 'Add Device Location' menu and then placing a magnet against the devices magnetic log on switch. *See the 'Magnet log on points' section for device log on points.*
- C) The device's LED will flash to indicate that the device has successfully communicated with the WZM.
- D) The device details are then received and displayed on the WZM.
- E) It is possible to accept the new device, or add another device in the same fashion, therefore creating a list at the WZM.
- F) When these details are accepted, the device is added to the WZM.

Remove device

This section allows wireless devices to be removed from the system. A list of devices already allocated to the system are shown, these can be scrolled through by using the  and  buttons. The required device to be removed can be selected by using the .

Edit settings

This menu allows the user to change device text descriptions, allocate the device to a zone, allocate detection type, select detector sensitivity settings, change sounder volume and I/O operation for inputs and outputs. All of the above will have default settings. The available options and the default settings are shown in the following tables for each device type;

Dual detector

Attribute Type	Default setting
Address number	Next available address number on system
Device Display Text	The device type followed by the devices unique ident number (where xx = represents the ident number of the device)
Detection	Dual
Smoke Sen	Normal
Heat Sen	58°C static

Fire manual call point

Attribute type	Default setting
Address number	Next available address number on system
Device Display Text	The device type followed by the devices unique ident number (where xx = represents the ident number of the device)

Sounder

Attribute type	Default setting
Address number	Next available address number on system
Device Display Text	The device type followed by the devices unique ident number (where xx = represents the ident number of the device)
Sounder volume	High

Sounder beacon

Attribute Type	Default setting
Address number	Next available address number on system
Device Display Text	The device type followed by the devices unique ident number (where xx = represents the ident number of the device)
Sounder volume	High
Audio/Visual	On

Detector sounder

Attribute type	Default setting
Address number	Next available address number on system
Device Display Text	The device type followed by the devices unique ident number (where xx = represents the ident number of the device)
Detection	Dual
Smoke Sen	Normal
Heat Sen	58°C static
Sound volume	High

Detector sounder and beacon

Attribute type	Default setting
Address number	Next available address number on system
Device Display Text	The device type followed by the devices unique ident number (where xx = represents the ident number of the device)
Detection	Dual
Smoke Sen	Normal
Heat Sen	58°C static
Sound volume	High
Audio/Visual	On



Dual input / output device

Attribute type	Default setting
Address number	Next available address number on system
Device Display Text	The device type followed by the devices unique ident number (where xx = represents the ident number of the device)
O/P 1 OFF	Reset
O/P 2 OFF	Reset

Signal level test

This mode of operation allows the signal strength of a single device on the system or all devices globally on the system to be indicated via the devices on board LEDs. The signal strength level is shown by flashing the individual devices LED to ascertain the devices signal strength level. This is split into two colours :- green for 'GOOD' signal and red for 'LOW' signal. The signal strength status LED would update periodically to allow an updated reading to be shown.

View all devices

When entered the screen will show the current settings for the devices on the system. The device listings can be scrolled through by using the   ons.

WZM settings

The 'WZM settings' menu allows an engineer to program various WZM options. The available options are explained in more detail below.

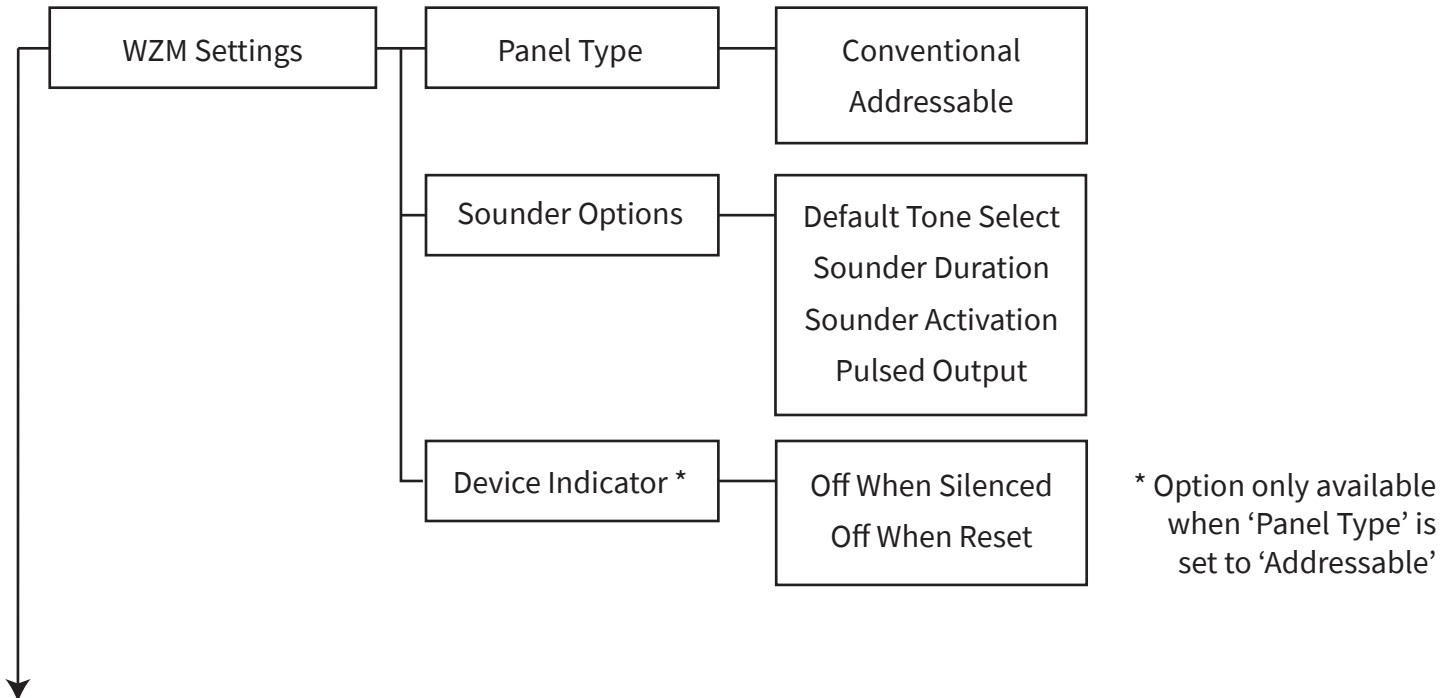

Panel type

This menu option changes the operation of the WZM; to work in conjunction with either a conventional fire control panel, or an addressable fire control panel. The default setting is 'Conventional'.

The LCD front display will state whether conventional mode or addressable mode is selected.

Sounder Options

The operation of the wireless sounders to be programmed in this menu. Available options are as follows:

Default Tone Select

This menu option allows the selection of the default sounder fire alarm tone.

Sounder Duration

This menu option allows has two available options. They are as follows:

- Continuous 'Upon a fire event, wireless sounders will continue to ring, until they are silenced.
- 30 Min Cut Off 'Upon a fire event, wireless sounders will be automatically switch off after 30 minutes, to conserve battery life. Subsequent fire alarm activations will re-activate the sounders.

The default setting is 30 min cut off.

Sounder Activation

As default, the WZM's wireless sounders will only operate upon the WZM's Fire Input being triggered. This however can be changed, so that sounders operate, upon the activation of one of the WZM's wireless devices.

Pulsed Output

This menu option allows has two available options. They are as follows:

- Fire Relay 'Allows the relay output to change state upon a fire event for a preset period of time. Available durations in seconds are 0 (output off), or 5-60 seconds (in 5 second increments).
- Fault Relay 'Allows the relay output to change state upon a fault event for a preset period of time. Available durations in seconds are 0 (output off), or 5-60 seconds (in 5 second increments).

The default setting is 0 seconds (output off).

Device Indicator

This menu allows the programming of the wireless devices alarm indicator led operation. If the devices led operation is required to be controlled by a separate Reset input (Input 2) then this function should be selected (EN requirement). A change of state will be required on Input 2 when the system is reset. This will allow the Wireless Zone Monitor to send a reset signal to the wireless devices to extinguish their alarm indicator LED's if they have been triggered.

Off When Silenced

This menu allows the method of control for the wireless devices individual alarm indicator to be selected. The options are for the devices indicator which has alarmed and is in the on state to turn off on receipt of a SILENCE command signal. This is generated when the fire input clears (Input 1) and will therefore work the same as sounders on the Zone Monitor.

Off When Reset

This menu allows the method of control for the wireless devices individual alarm indicator to be selected. Alternatively the devices indicator can be selected so it extinguishes only after a RESET command (Input 2 clear) has been activated. This requires a reset input wired from the control panel to Input 2 on the Wireless Zone Monitor. When this input is activated and subsequently clears a reset signal can be sent. This can be therefore be wired into a relay which changes state on a reset event or returns to a normal state when the panel is reset. The default operation is to turn off on a Silence command when the fire input clears (Input 1).

WZM information

The 'WZM information' menu allows an engineer to program various WZM options. The available options are explained in more detail below.

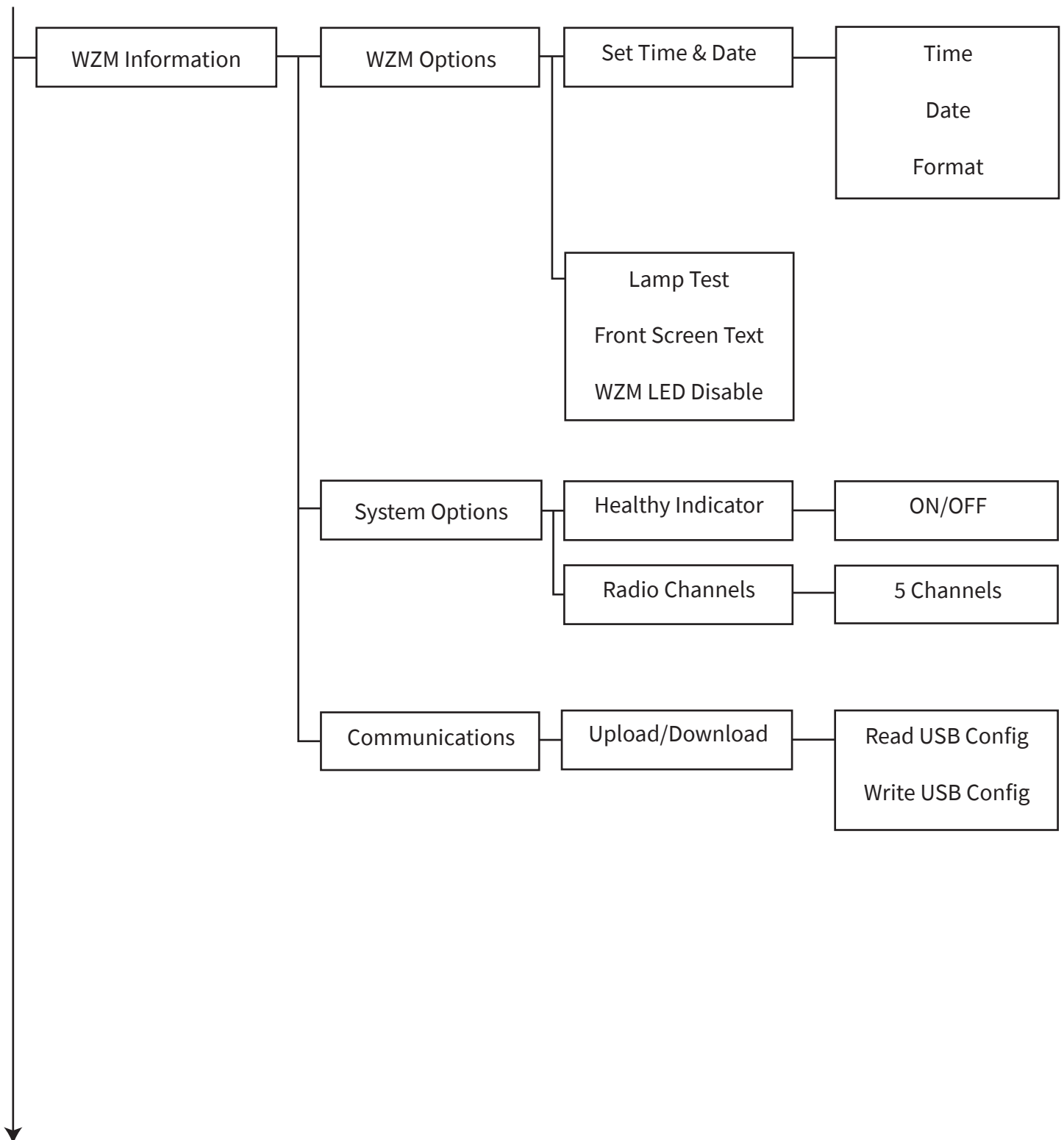

WZM Options

Set time & date

The 'Set Time & Date' menu allows an engineer to program the systems time and date. The time will be displayed on the WZM display and the time and date is also used for time stamping events in the event log. This menu option also allows the date format to be changed.

If the time and date is not set on the WZM the following display will be shown:

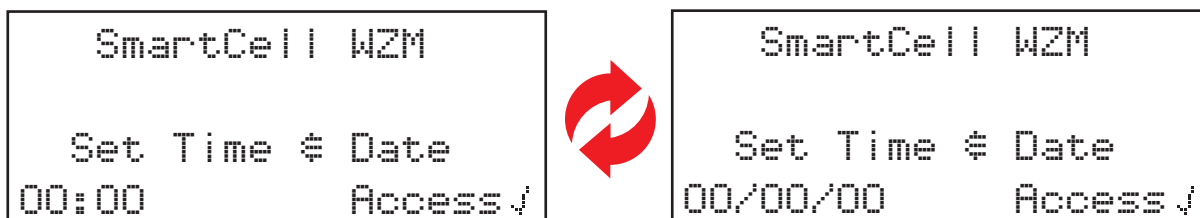

Lamp Test

This option when entered performs a lamp test on the WZM.

Front Screen Text

The front screen text can be edited in this menu.

WZM LED Disable

This menu option allows the engineer to disable the WZM's external status LEDs.

System Options

Healthy Indicator

The system has the capability of showing on each individual device a health indication LED. This menu allows this functionality for the devices to be selected. The default setting is for the LED to flash on a device every poll, which is every 2 minutes. If the device is in a fault free healthy condition this will flash green, if the device is in any fault condition the flash will be a yellow flash. Once the device is fault free the indicator LED will return to green. This indication feature can be turned 'ON' or 'OFF' from this menu.

Radio Channels

This menu allows you to view the frequency channels currently used by the system. The radio channels used for the system are factory set. Any monitoring and channel changes can be undertaken using the configuration tool.

Language

This feature is not currently supported in this version of software.

Reports

A number of reports are available to be written to a USB memory stick, connected to the panel's USB-A connection. These can be saved or printed out accordingly thereafter. The available options are explained in more detail below.

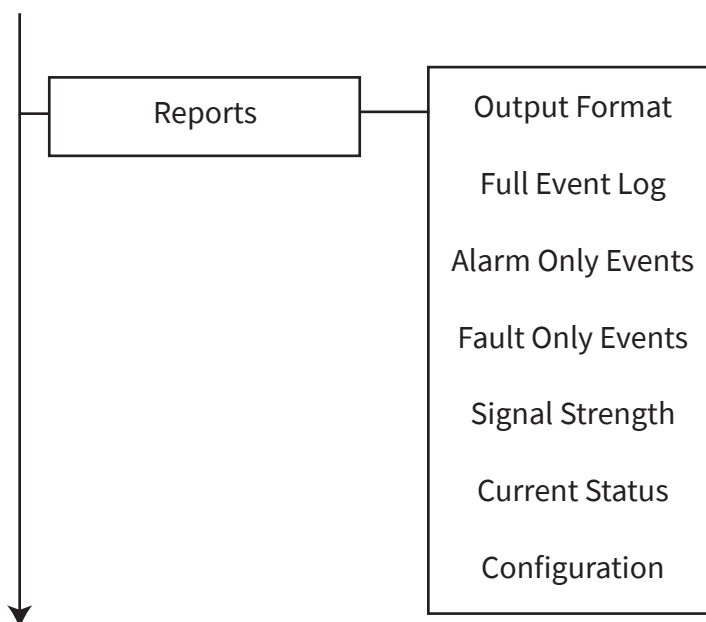

Output format

When selected, exported data can be downloaded in 'CSV', 'JSON' and 'XML' formats.

Full event log

When selected, the full event log will be downloaded.

Alarm Only Events

When selected, an event log containing alarm events only will be downloaded.

Fault Only Events

When selected, an event log containing fault events only will be downloaded.

Signal strength

When selected, all device signal levels including current, minimum and maximum levels will be downloaded. These are displayed as 'GOOD', 'LOW', 'NO SIGNAL', along with their associated level in dB.

Current status

When selected, the current status information from all devices will be downloaded.

Configuration

When selected details of the full system setup including all zone, device details and panel programmed parameters will be downloaded.

Access level 4

This option allows the ability for an access level 4 factory access code to be entered. At access level 4, all the WZM's controls are functional and the WZM's factory menu is fully accessible allowing full software configuration. Access level 4 access is reached by entering the factory access code.



Logout

When selected the logout option will return the user to the front display immediately. Access to the WZM's menus would need to be re-started I.e. access code re-entered.

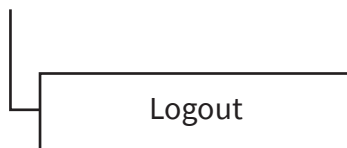

Product conformance

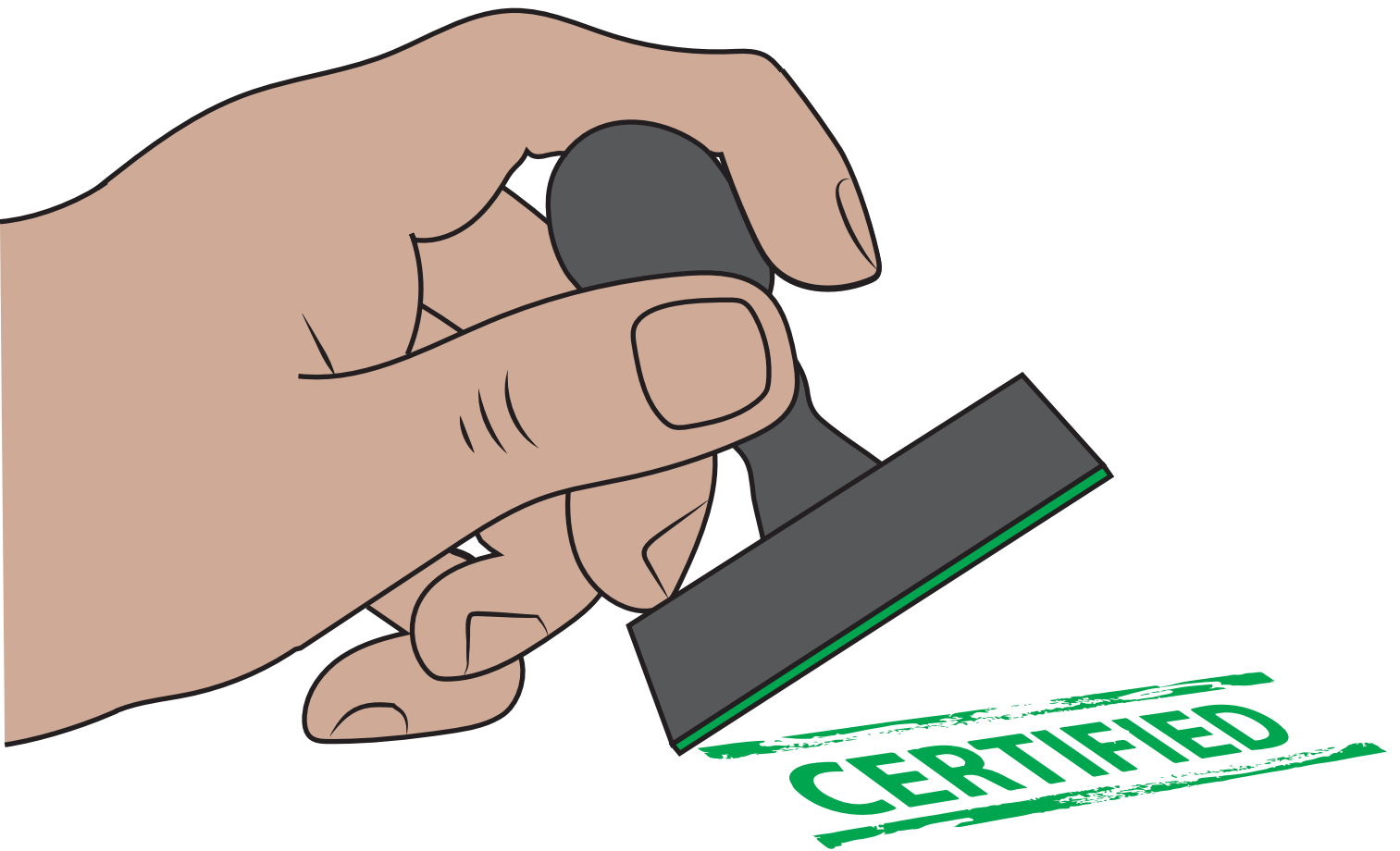

Compatible wireless fire products and details of their conformance and part numbers are listed below:

Wireless Zone Monitor

CPR DoP:

0359-CPR-00427

Approved to:

EN54-13, EN54-18 and EN54-25.

Part numbers:

Variation:

SC-13-1100-0001-99 Intelligent Wireless Zone Monitor (230 VAC version)

SC-13-2100-0001-99 Intelligent Wireless Zone Monitor (24 VDC version)

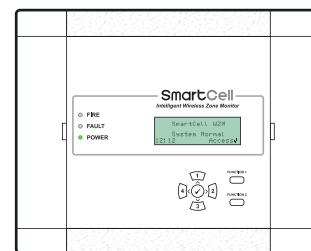

Wireless dual smoke / heat detector

CPR DoP:

0359-CPR-00265

Approved to:

EN54-5, EN54-7, EN54-13 and EN54-25.

Part number:

Variation:

SC-21-0200-0001-99 Dual smoke / heat detector

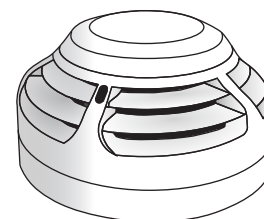

Wireless dual smoke / heat detector and combined sounder

CPR DoP:

0359-CPR-00268

Approved to:

EN54-3, EN54-5, EN54-7, EN54-13 and EN54-25.

Part number:

Variation:

SC-22-0200-0001-99 Dual smoke / heat detector and combined sounder

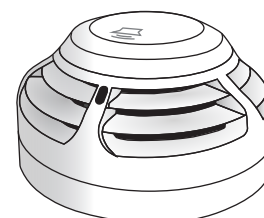

Wireless dual smoke / heat detector & combined sounder beacon

CPR DoP:

0359-CPR-00268

Approved to:

EN54-3, EN54-5, EN54-7, EN54-13, EN54-23 and EN54-25.

Part Numbers:

Variation:

SC-23-0220-0001-99 Dual smoke / heat detector and combined sounder-beacon (VAD white flash)

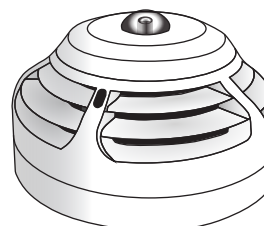

Wireless fire manual call point

CPR DoP:

0359-CPR-00266

Approved to:

EN54-11, EN54-13 and EN54-25.

Part number:

SC-51-0100-0001-99

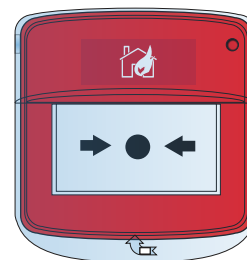

Wireless sounder

CPR DoP:

0359-CPR-00428

Approved to:

EN54-3, EN54-13 and EN54-25.

Part numbers:

SC-31-0100-0001-99 RED sounder

SC-31-0200-0001-99 WHITE sounder

Variation:

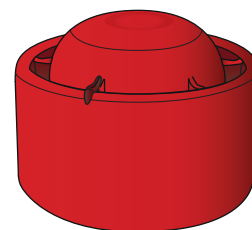

Wireless sounder and ceiling beacon

CPR DoP:

0359-CPR-00428

Approved to:

EN54-3, EN54-13, EN54-23 and EN54-25.

Part numbers:

SC-33-0120-0001-99 RED sounder and ceiling beacon (VAD white flash)

SC-33-0220-0001-99 WHITE sounder and ceiling beacon (VAD white flash)

Variation:

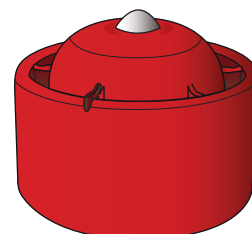

Wireless sounder and wall beacon

CPR DoP:

0359-CPR-00428

Approved to:

EN54-3, EN54-13, EN54-23 and EN54-25.

Part numbers:

SC-32-0120-0001-99 RED sounder and wall beacon (VAD white flash)

SC-32-0220-0001-99 WHITE sounder and wall beacon (VAD white flash)

Variation:

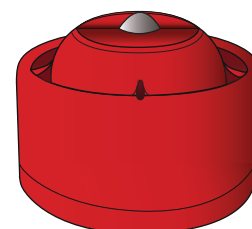

Wireless dual input dual output device

CPR DoP:

0359-CPR-00269

Approved to:

EN54-13, EN54-18 and EN54-25.

Part number:

SC-41-0200-0001-99

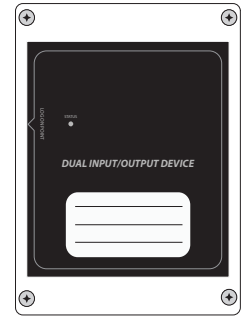

SmartCell

www.mysmartcell.com

The information contained within this literature is correct at time of publishing. EMS reserves the right to change any information regarding products as part of its continual development enhancing new technology and reliability. EMS advises that any product literature issue numbers are checked with its head office prior to any formal specification being written.