



Universal PSU (FireCell variant) Installation Guide

General

The universal PSU (FireCell variant) is available under the following part number:

Part no	Variant type
FC-60-1000	Universal PSU (FireCell variant)

The universal PSU has been designed to be fitted within the FireCell Radio Cluster Communicator (RCC). Please see FireCell installation & programming instructions for information on back box mounting, mains supply cable entry points and programming information. Please note: The universal PSU has no serviceable parts, so no attempt should be made to access the inside of the power supply unit (PSU).

Overview of the PSU

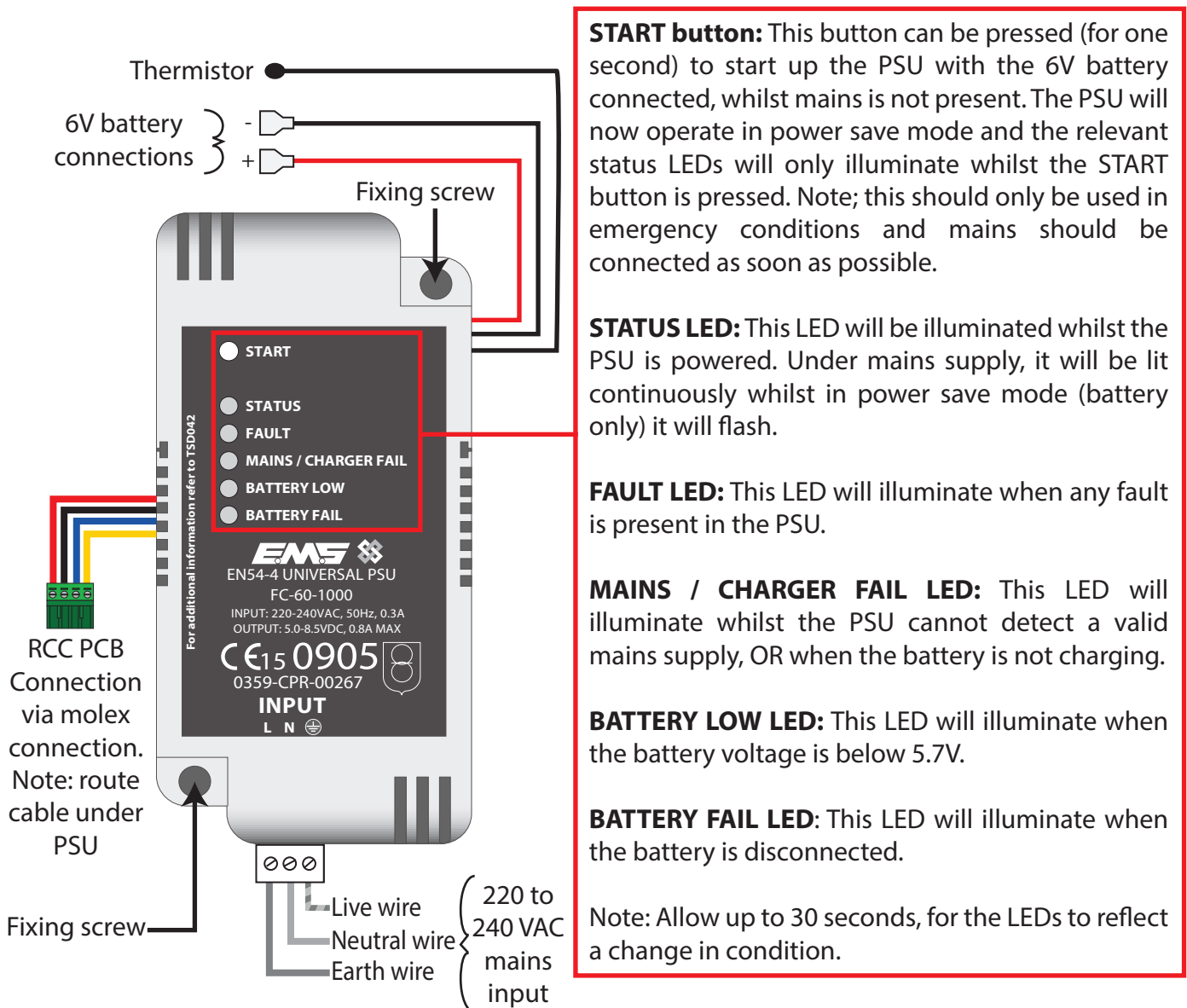

Figure1

Installation of the PSU

The following steps should be followed in order to install the PSU into the FireCell RCC.

Step 1 * Disconnect mains supply

The mains supply must be disconnected before any further work commences.

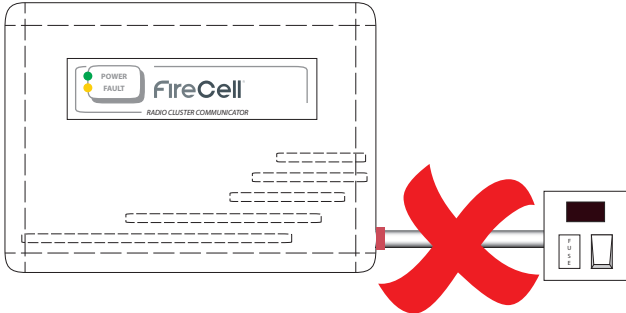

Note: This will result in temporary fault conditions which will clear once this process is complete.

Step 2 * Remove lid

To remove the RCC lid, all four corner pieces and screws must be removed.

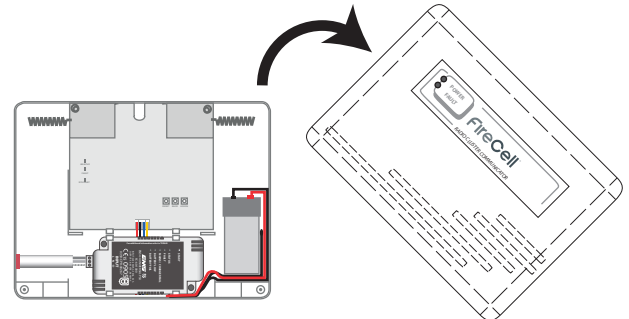

Step 3 * Remove battery

Carefully disconnect and remove the RCC battery. The battery should be kept in a safe place and protected against short circuit.

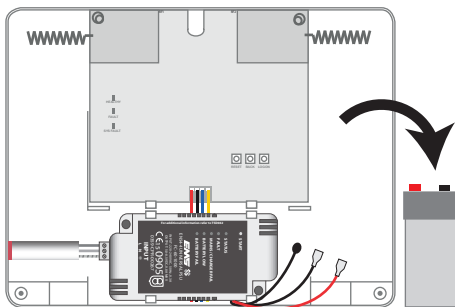

Note: ensure excessive strain is not placed on the wires or terminals when removing the connections.

Step 4 Remove mains connections

Remove the mains wiring connections.

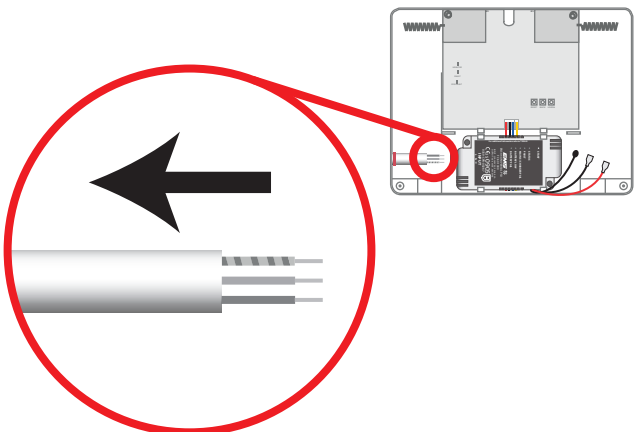

Step 5 Remove fixing screws

Unscrew the two PSU fixing screws.

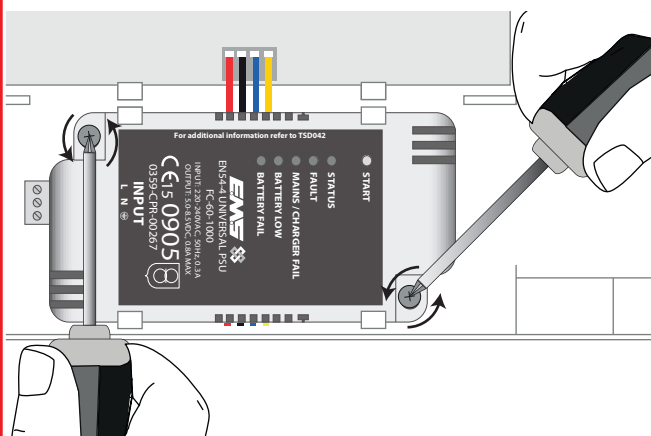

Step 6 Unplug ribbon cable

Unplug the PSU ribbon cable connector from the RCC PCB.

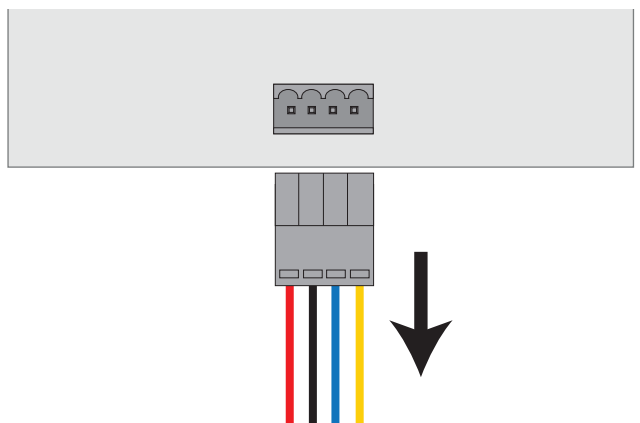

Step 7 Remove PSU

Remove the PSU from the RCC housing.

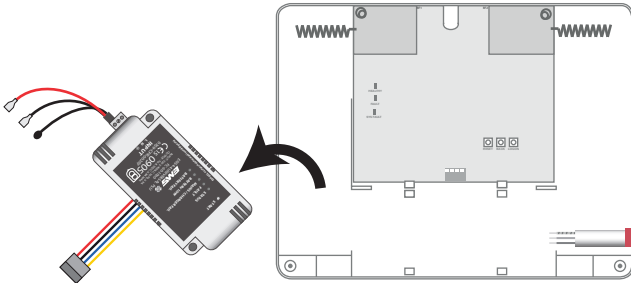

Step 8 RCC housing modification

If upgrading from a previous version of power supply, a small modification to the RCC housing will be required. This includes removing the retaining clips, as they are no longer needed. This is detailed below.

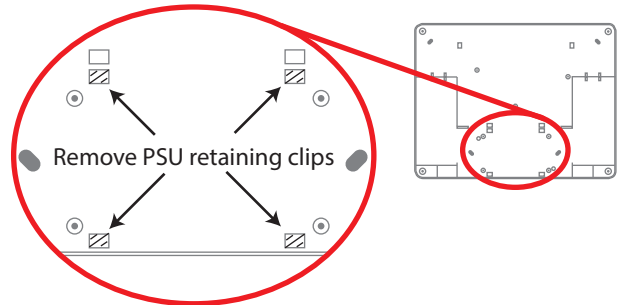

(Remove shaded clips only)

Step 9 PSU orientation

The PSU is designed so that it can be fitted in two different orientations, allowing mains entry to the left or right hand side of the RCC housing. Therefore it is important that the PSU is fitted in the correct orientation.

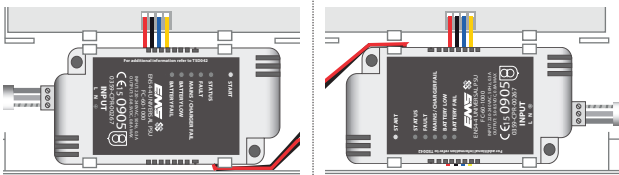

Mains supply from the left hand side.

Mains supply from the right hand side.

Step 10 Insert PSU

The new PSU can now be fitted. If Step 8 was **NOT** followed, the PSU must now be clipped back in to place. Note; the PSU's ribbon cable should run underneath the PSU, when mains connections are made to the right hand side. The ribbon cable connector should also be reconnected to the PSU.

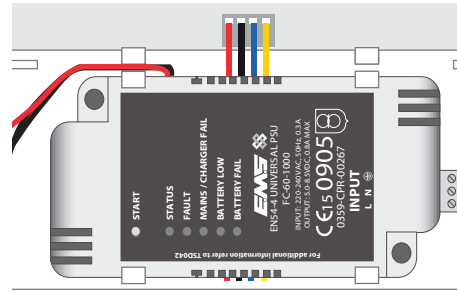

Step 11 Secure PSU

Secure the PSU into place, fitting the new PSU retaining screws, supplied with the replacement PSU.

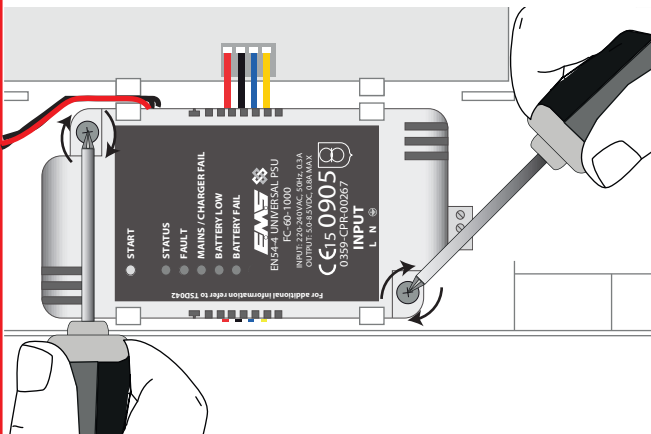

Step 12 Remake mains connections

Remake the mains connections, as shown below.

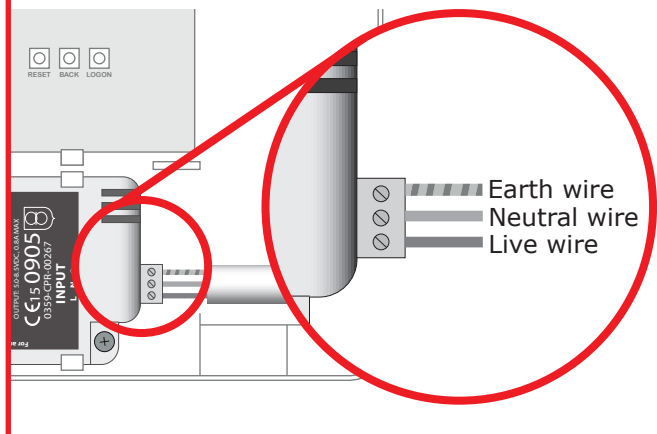

Step 13 * Replace battery

Fit the battery into the battery compartment. House the thermistor and fit the connectors as shown, ensuring correct polarity is observed.

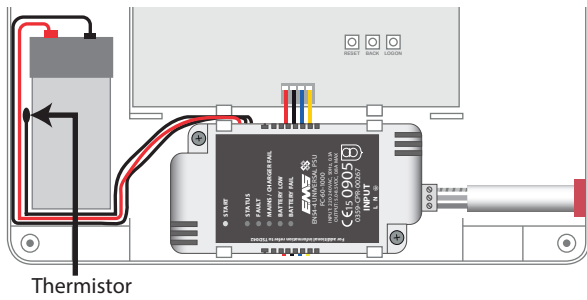

Step 14 * Refit lid

Refit the lid ensuring all four screws and corner pieces are fitted.

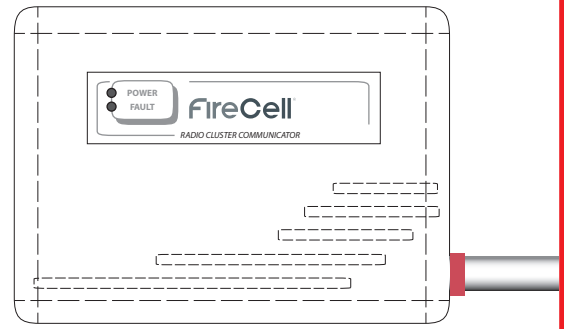

Step 15 * Reinstall mains supply

Reapply the mains supply to the RCC.

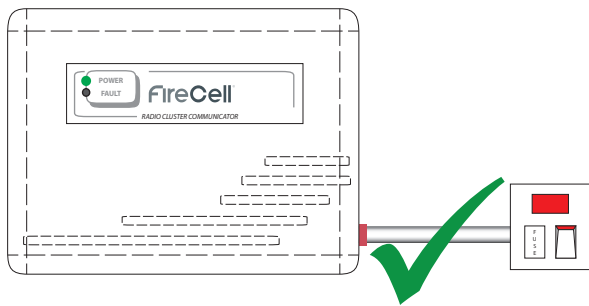

Step 16 * Check Radio Hub

Check that after 5 minutes the RCC fault has cleared at the Radio Hub, along with the faults from associated devices. Once clear, the installation process is complete.

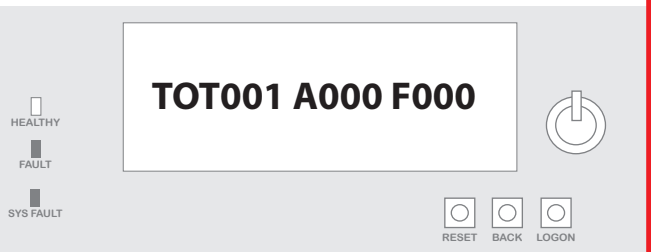

* When carrying out a routine battery change (within 5 years and as required), steps 1, 2, 3, 13, 14, 15 and 16 can be followed. Ensure that a correct battery type is used. See the Specification section for more information.

Specification

Operating temperature	- 10 to + 55 °C
Power requirements	Mains powered 220 to 240 VAC
Current consumption*	44 mA (normal operation) 55.5 mA (with mains disconnected)
*When connected to the RCC	
Min/max electrical ratings	Input: 220 to 240 VAC, 50 Hz, 0.3 A Output current: Imin 0.0 Amps, Imaxa 0.8 Amps, Imaxb 0.8 Amps
Input / output fuse ratings	Input: T3.15 A (non replaceable) Output: 300 mA and 750 mA max (resettable)
Battery backup	1 x 6V 4Ah Yuasa NP4-6
Battery standby time	72 hours*
*Typical 5 year battery life based on normal usage. Note; if 72 hours battery standby is required, it is recommended that the battery is replaced every 3 years.	
Maximum battery internal resistance	0.7 Ohms
Dimensions (W x H x D)	53 x 110 x 9 mm
Weight	150 g

Regulatory information

Manufacturer	Carrier Manufacturing Polska Sp. Z o.o. Ul. Kolejowa 24. 39-100 Ropczyce, Poland
Certification	CE 15
Certification body	0905
CPR DoP	0359-CPR-00267
Approved to	EN54-4:1998 Incorporating amendments Nos. 1 and 2. Fire detection and fire alarm systems. Part 4: power supply equipment.
Application	Intended for use in fire detection and fire alarm systems in and around buildings. Indoor use only.
European Union	EMS hereby declares that this device is in compliance with Directive 2014/53/EU. The full text of the EU declaration of conformity is available at the following internet address: www.emsgroup.co.uk



2012/19/EU (WEEE directive): Products marked with this symbol cannot be disposed of as unsorted municipal waste in the European Union. For proper recycling, return this product to your local supplier upon purchase of equivalent new equipment, or dispose of it at designated collection points. For more information see www.recyclethis.info
Dispose of your batteries in an environmentally friendly manner according to your local regulations.