



# FireCell

## FC-868-SE2 Survey Kit User Guide



# Contents

<b>Start</b>	<b>3</b>
Introduction	4
<b>About The Survey Kit</b>	<b>5</b>
Survey Kit Overview	6
Signal Surveyor Features	7
Using the Signal Surveyor	7
Signal Surveyor Battery Replacement	8
Device Survey Tool Features	8
Device Survey Tool Battery Replacement	8
Using the Device Survey Tool	9
Survey Results Explained	9
<b>Fusion RLM Survey</b>	<b>10</b>
Fusion RLM Survey Objectives	11
Typical Fusion RLM System Overview	11
Fusion RLM Survey Guidelines	11-13
Step By Step Guide - Fusion System Survey	14
Fusion RLM Survey Form	15
<b>FireCell Survey</b>	<b>16</b>
FireCell Survey Objectives	17
Typical FireCell System Overview	17
FireCell System Survey Guidelines	17-18
Step By Step Guide - FireCell Hub/RCC to RCC Surveying	19
FireCell Hub/RCC to RCC Survey Form	20-21
Step By Step Guide - FireCell Device to RCC Surveying	22
FireCell Device to RCC Survey Form	23

# Start



## Introduction

This manual provides a guide to using the FireCell 868MHz wireless survey kit.

The wireless survey kit should be used to determine the FireCell equipment requirements for the site, to ensure that full wireless site coverage for the areas concerned is achieved, with the required signal strengths for reliable communication.

Each site will have a level of background noise, that may affect the signals on site. Under EN54-25 (Fire detection and fire alarm systems components using radio links). The minimum signal headroom must be checked, to ensure reliable communication. This is essential to ensure immunity against site attenuation, caused by environmental changes and other electrical equipment.

The survey will create the foot print for the installed system, specifying the final positions for the devices and wireless infrastructure.

The FireCell wireless survey kit has been designed so that it can survey both FireCell and Fusion Radio Loop Module (RLM) systems.

All wireless communication is bi-directional and utilises the 868MHz frequency.

It is recommended that the survey results are recorded for future reference. The survey kit automatically calculates the required headroom (signal level above background interference), then displays the results. The results are displayed together with Pass or Fail confirmation.

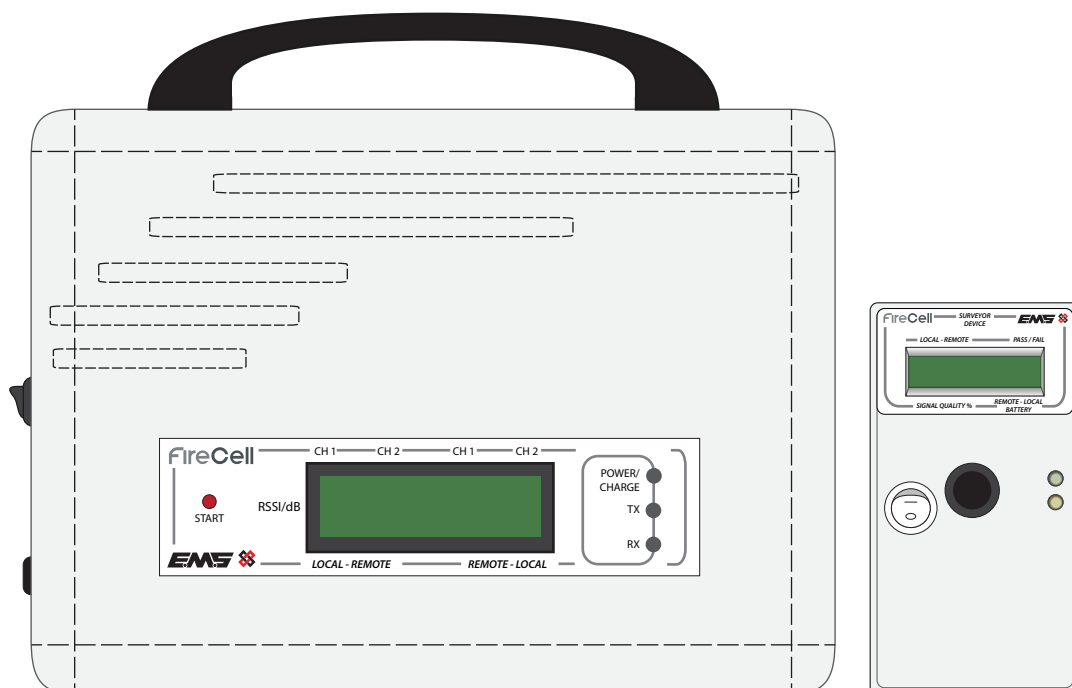

# About The Survey Kit



# Survey Kit Overview

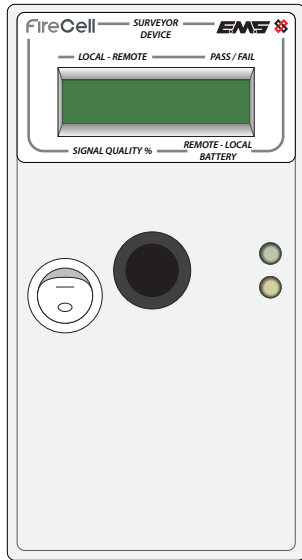

## Pole Mounted Survey Tool (1 per kit)

This part of the survey equipment when used in conjunction with the Signal Surveyor Unit, identifies accurate signal strength information between the two points. Since wireless devices and RCCs both communicate using the same 868MHz wireless protocol, the process for device to RCC/RLM surveys is the same as RCC to Hub/RCC surveys.

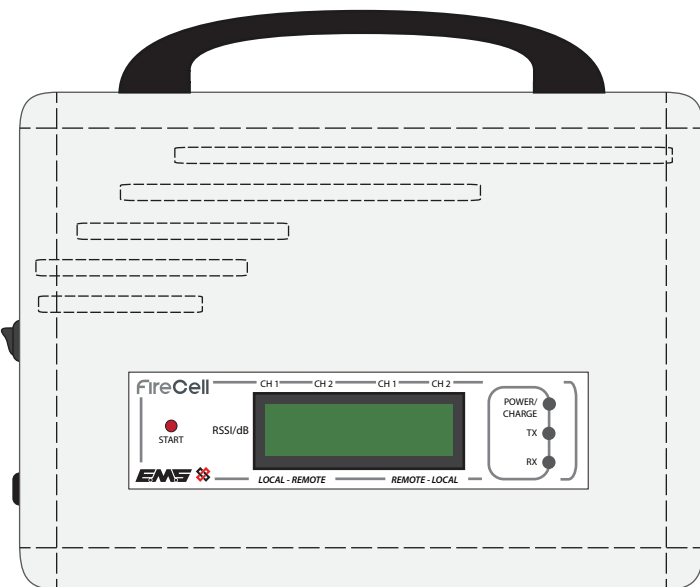

## Signal Surveyor (1 per kit)

This part of the survey equipment is used to communicate with the Device Survey Tool. This unit will be located in the position of the proposed Hub, RCC or RLM.

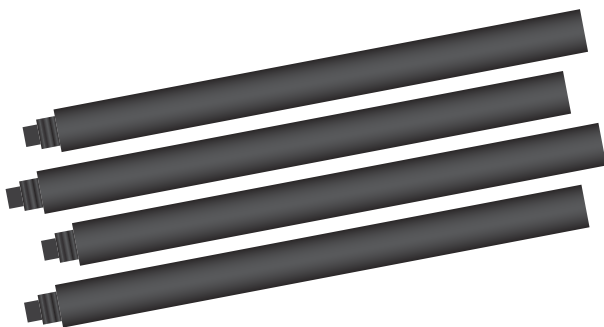

## Device Survey Poles (4 per Kit)

The survey poles are used for connection into the Device Survey Tool. This allows results to be taken from device locations which are out of reach.

*Note: to ensure optimum surveying accuracy, it is recommended that minimum two polls are used with the Survey Tool.*

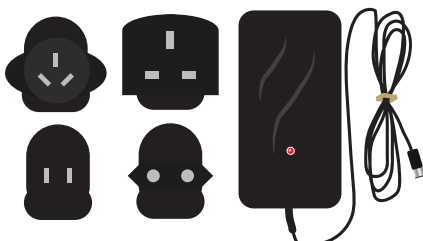

## Signal Surveyor mains charger (provided separately)

The mains charger is used for connection into the Signal Surveyor units for re-charging the devices on board battery.

## Signal Surveyor Features

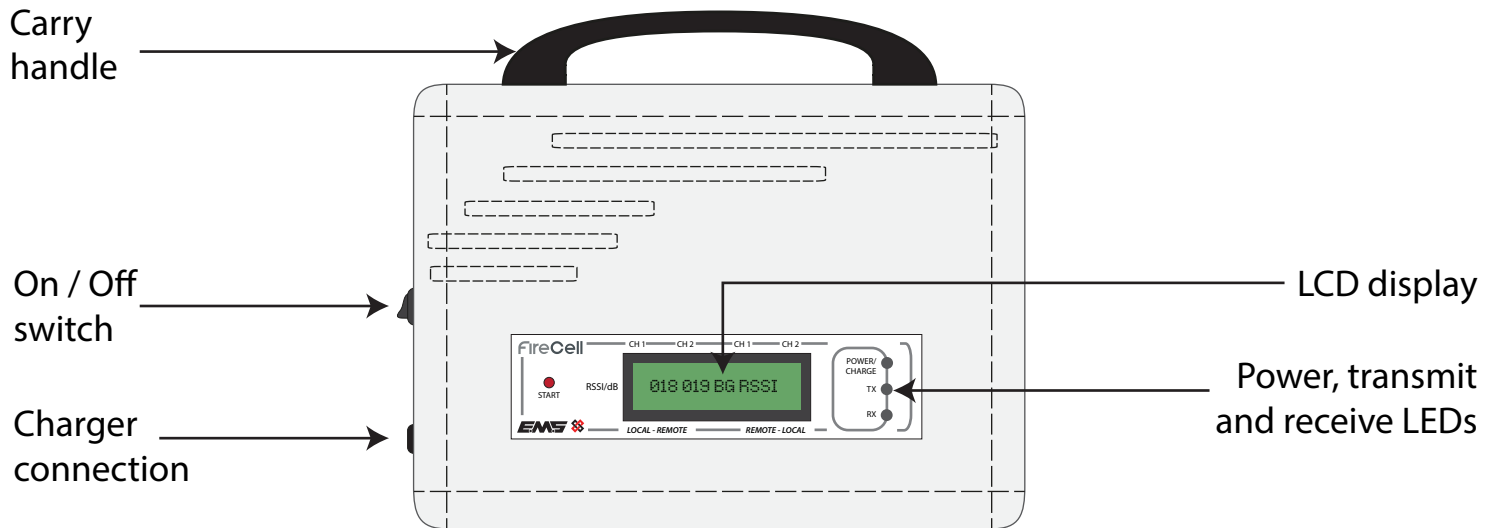

## Using the Signal Surveyor

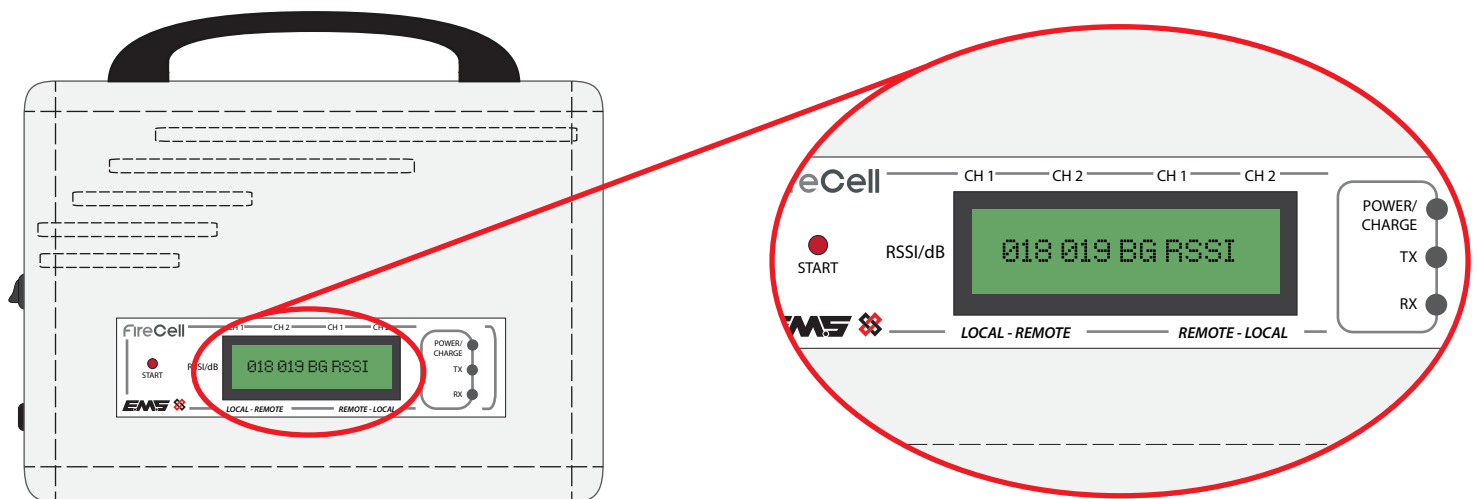

Once switched on, the Signal Surveyor's display will show the current background interference level. To achieve the maximum signal distance the background level should be as low as possible. This level is shown between 000 and 100. If the background levels are high, try repositioning the unit. Then turn off and back on again. This will re-show the background level for the new position.

BG RSSI	Recommendation
21-100	High Level Must Re-position Unit
11-20	Medium Try Re-positioning Unit
0-10	Low Continue with survey

## Signal Surveyor Battery Replacement

The Signal Surveyor's mains charger can be left connected if necessary, during the survey process. The rated mains supply voltage is between 90-264Vac 47-63Hz 0.35A max.

Authorised chargers limit output current to 1.0A

Should the internal battery require replacement, correct polarity must be observed as marked on the battery (NP4-6 6V, 4.0Ah) red wire = positive, black wire = negative.

## Device Survey Tool Features

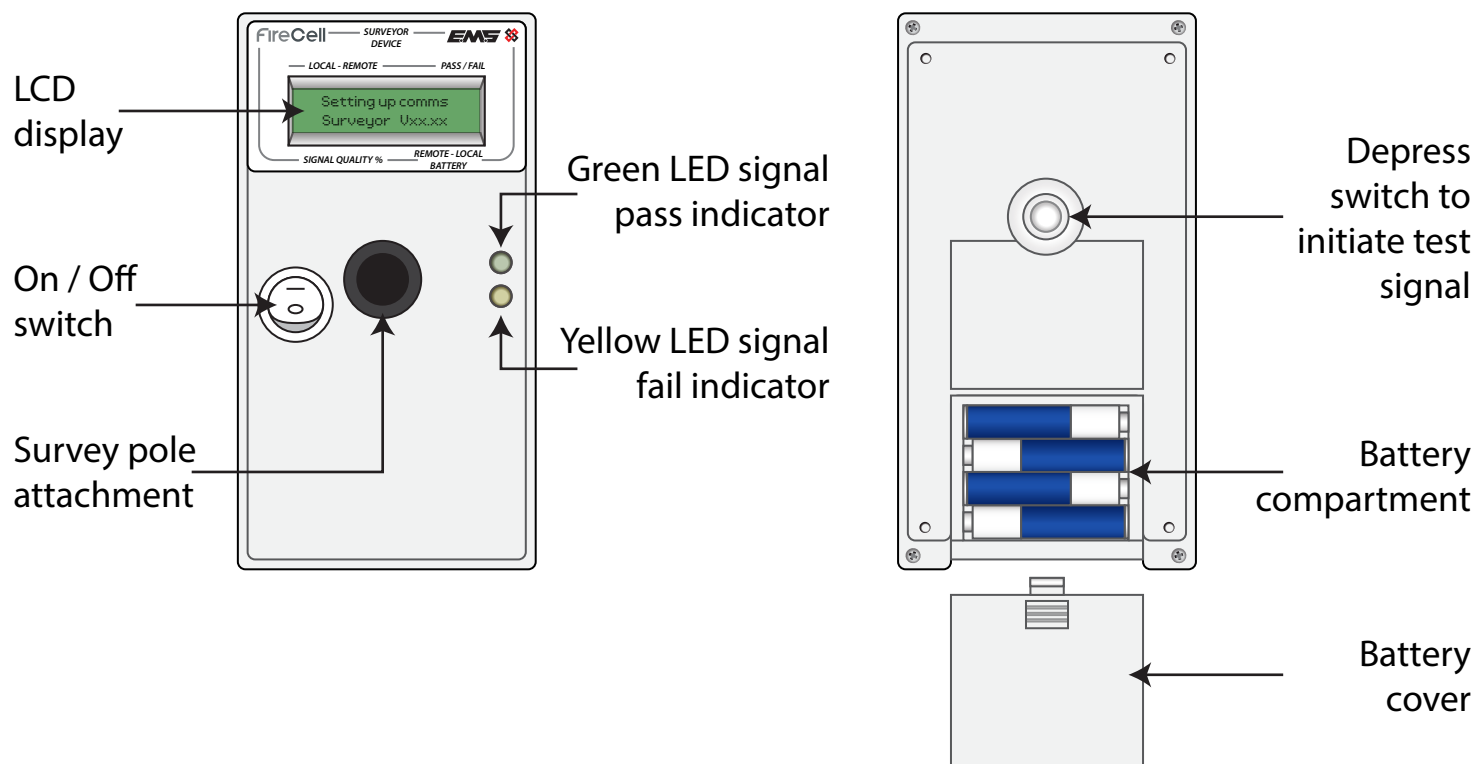

## Device Survey Tool Battery Replacement

The device Survey Tool requires 4 x AA (LR6 Alkaline 1.5V) batteries. Please ensure batteries are installed in the correct polarity as shown above.



# Using the Device Survey Tool

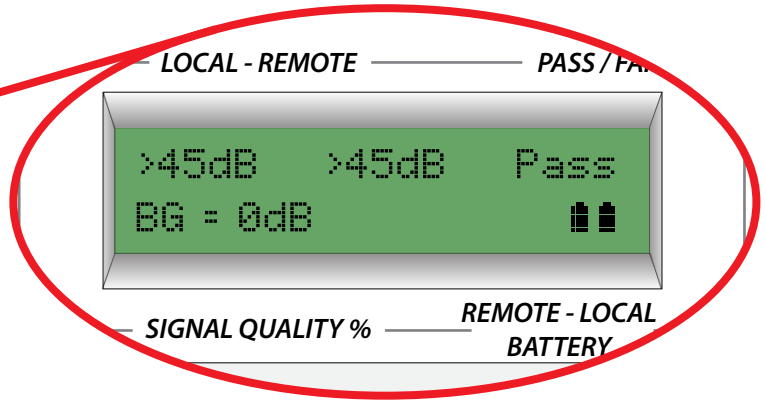
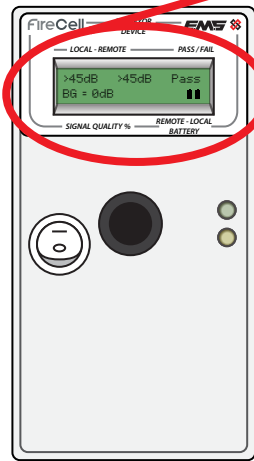

*Note; the battery icons shown above (bottom right of display), will alternate with a test number also shown.*

With the Device Survey Tool switched on, depress the rear switch to initiate a signal. After a few seconds results will be displayed and a high pass or a flat fail tone will be heard.

LED signal indication is also shown on the device, a Green LED indicates a Pass and the Yellow LED indicates a Fail.

**Whether undertaking a Fusion RLM or FireCell survey, a level of 24dB or above is required as a pass result.**



The background levels are taken into account prior to displaying the events on the units. If the required device position fails to pass the test then a further RLM/RCC position will need to be found closer to the device and the survey repeated. Every device position should be recorded along with the received signal levels.

## Survey Results Explained

The figures shown are explained as follows:-

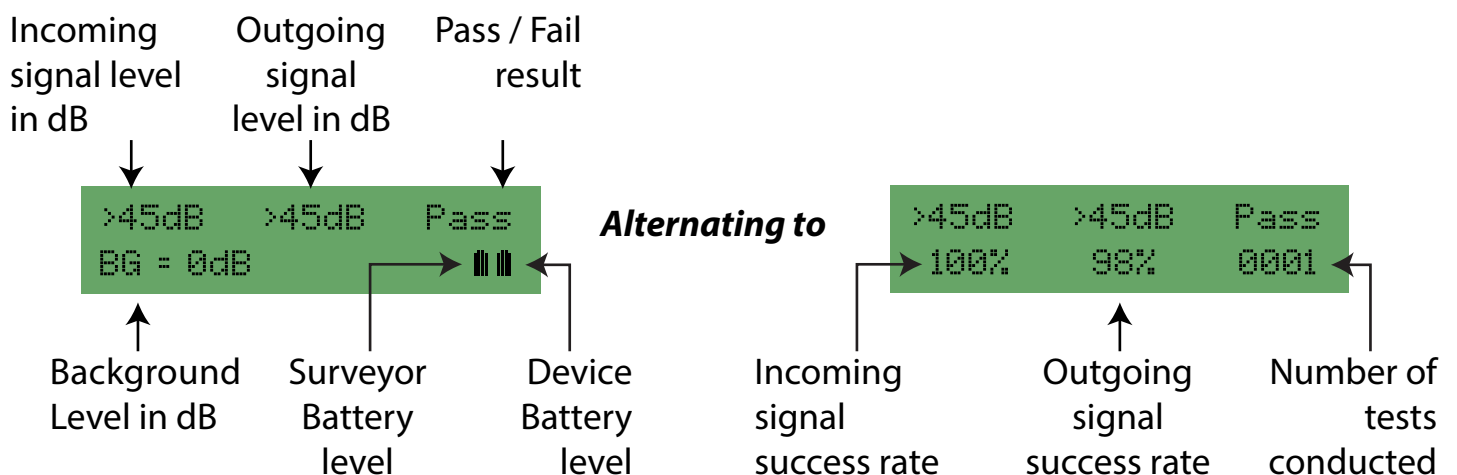

# FUSION RLM Survey

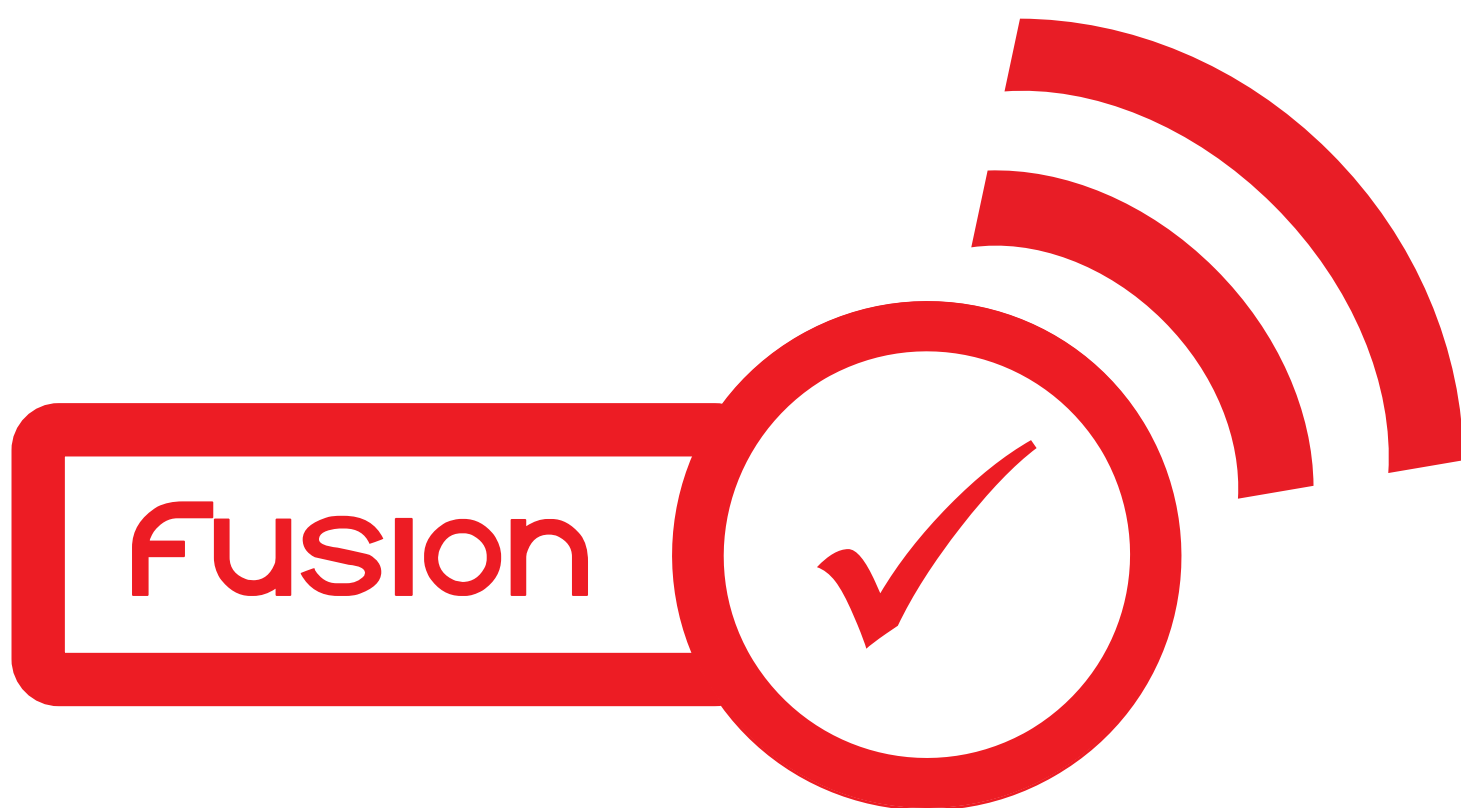

## Fusion RLM Survey Objectives

- Identify all Fusion RLM positions.
- Prove all wireless device communications are above 24dB and indicate a pass.
- When proving Wireless Door Control (WDC) communication, check for passes in the proposed final location\*, with the door both open and closed.

\* e.g. replicating final positioning on the bottom of the door / kick plate.

## Typical Fusion RLM System Overview

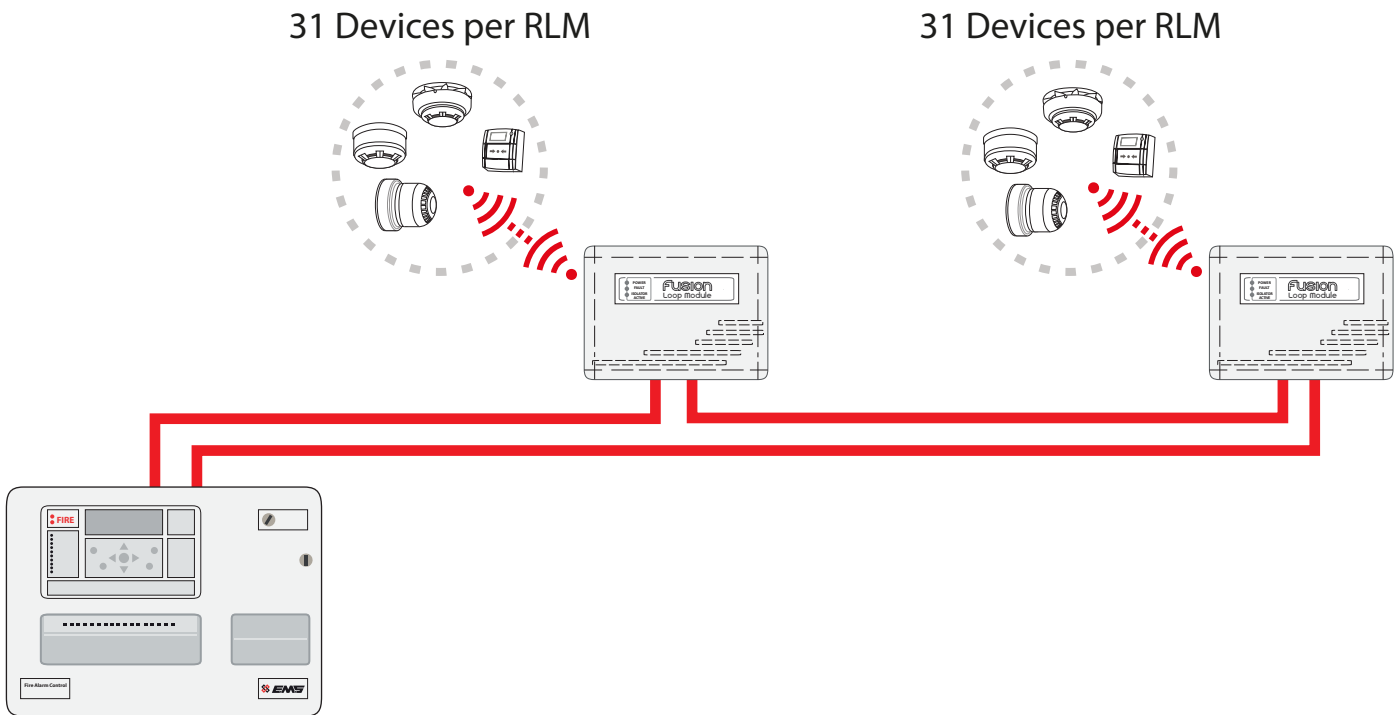

## Fusion RLM Survey Guidelines

Before you start surveying the premises there are a number of points to take into consideration that will aid the survey. These are as follows:-

1. Identify where the RLM is to be installed on the loop cabling. This is the starting point of the wireless infrastructure and where you should position your Signal Surveyor.



2. Remember when choosing a location, the RLMs require a loop in and out cable connection and a maximum of five RLMs per loop are allowed.

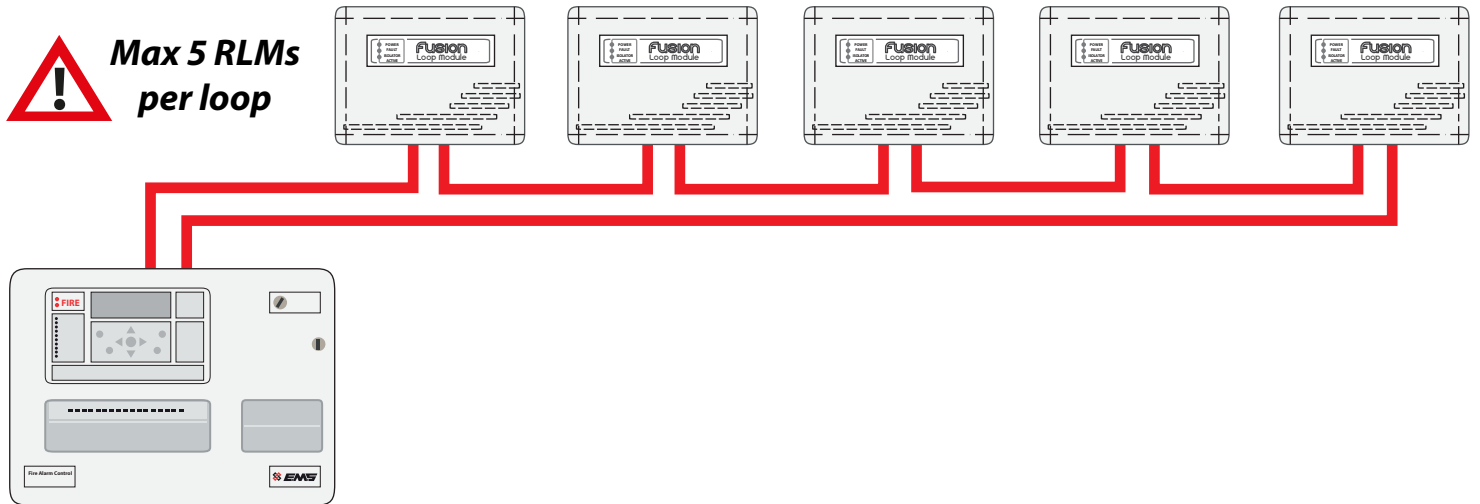

3. Remember to achieve maximum signal range, the RLM should be installed 600mm away from metal objects and other equipment and 2 metres from electrical equipment. This allows free space around the RLM's internal aerials.

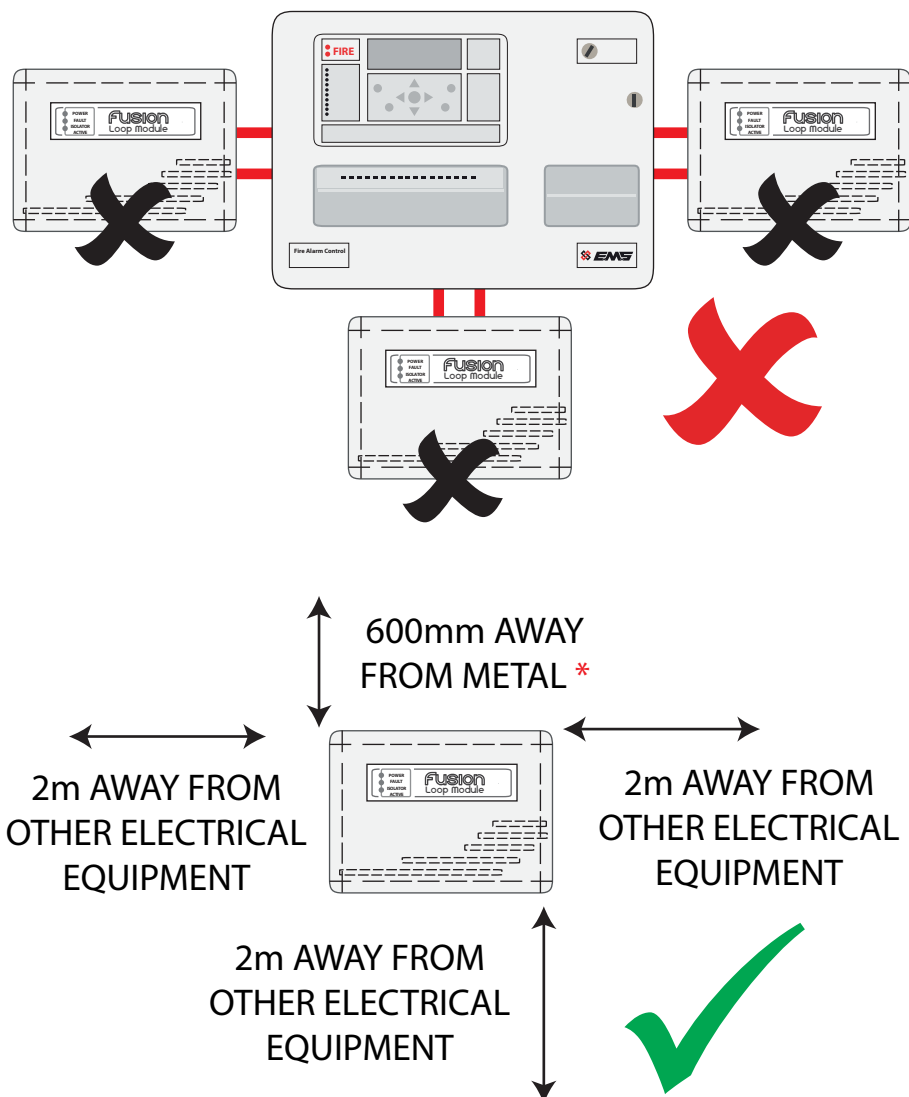

4. Consider positioning your RLMs centrally, giving as much 360 degree coverage as possible.

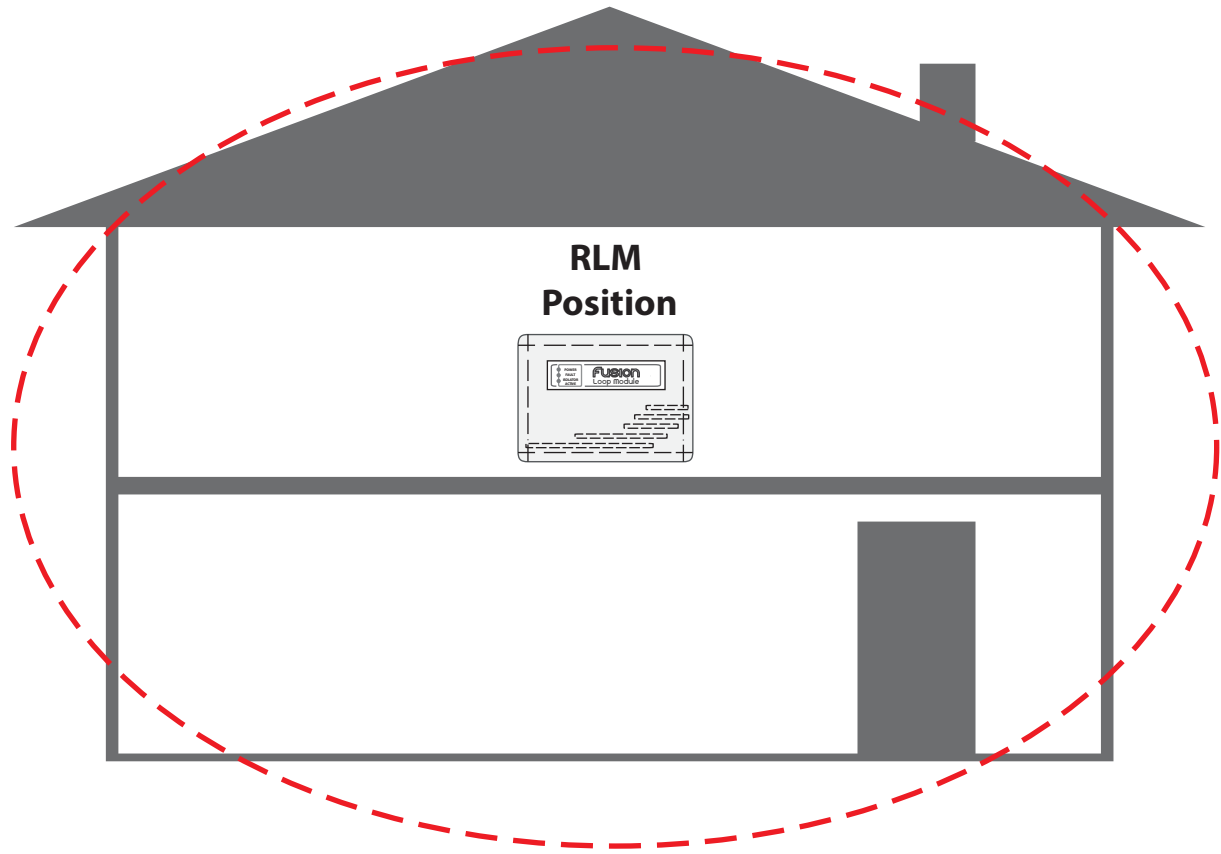

5. All Devices must have valid communication to an RLM (Pass Result).

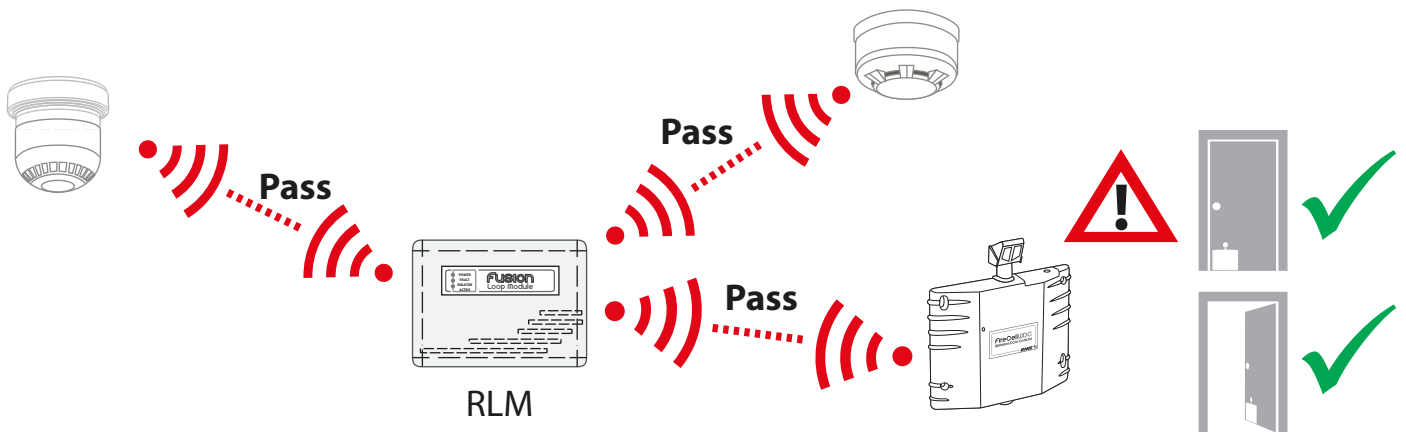

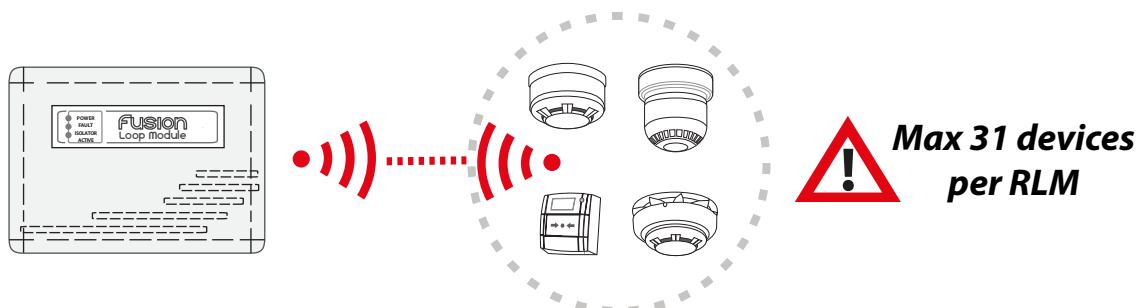

6. Remember, the RLMs can each accommodate a maximum of 31 wireless devices.

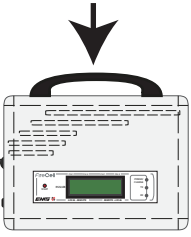
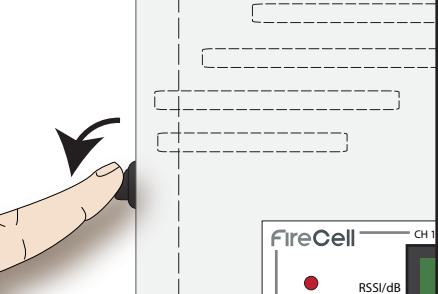
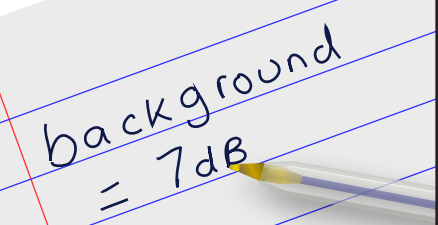
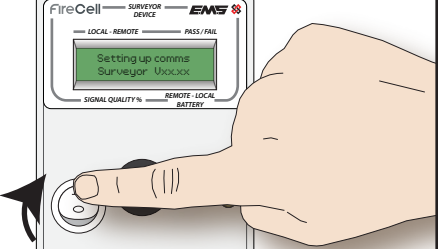
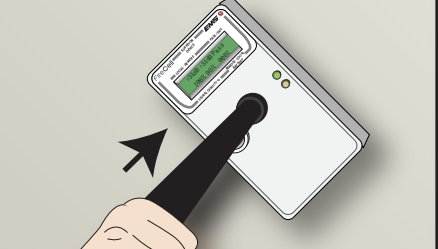
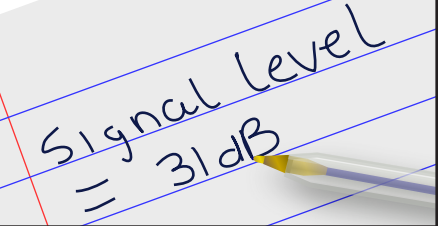

# Step By Step Guide - Fusion RLM System Survey

**Note: a Fusion RLM Survey Form is supplied on page 15.**

<p><b>Step 1.</b> Place the Signal Surveyor in the proposed final position of the RLM.</p>	 <p><b>Surveyor in RLM position</b></p>
<p><b>Step 2.</b> Turn on the Signal Surveyor.</p>	
<p><b>Step 3.</b> Record the background level displayed, for future reference. Refer to the Using the Signal Surveyor section for more information.</p>	
<p><b>Step 4.</b> Turn on the Device Survey Tool.</p>	
<p><b>Step 5.</b> Place the Device Survey Tool against the wall, ceiling or door* in the proposed final position of the wireless device. <i>* e.g. replicating final positioning on the bottom of the door / kick plate.</i></p>	
<p><b>Step 6.</b> Record the signal level.</p>	
<p><b>Step 7.</b> Repeat Steps 5-6 for all device positions associated with the RLM position.</p>	 <p><b>Steps 5 to 6</b></p>

# Fusion RLM Survey Form

Site \_\_\_\_\_ Customer name \_\_\_\_\_

Survey date \_\_\_\_\_ Company \_\_\_\_\_

Surveyor name \_\_\_\_\_

RLM number \_\_\_\_\_ Background Level \_\_\_\_\_

Device No	Signal Level				Pass	Fail	Comments
	[dB]		[%]				
1							
2							
3							
4							
5							
6							
7							
8							
9							
10							
11							
12							
13							
14							
15							
16							
17							
18							
19							
20							
21							
22							
23							
24							
25							
26							
27							
28							
29							
30							
31							

# FireCell Survey

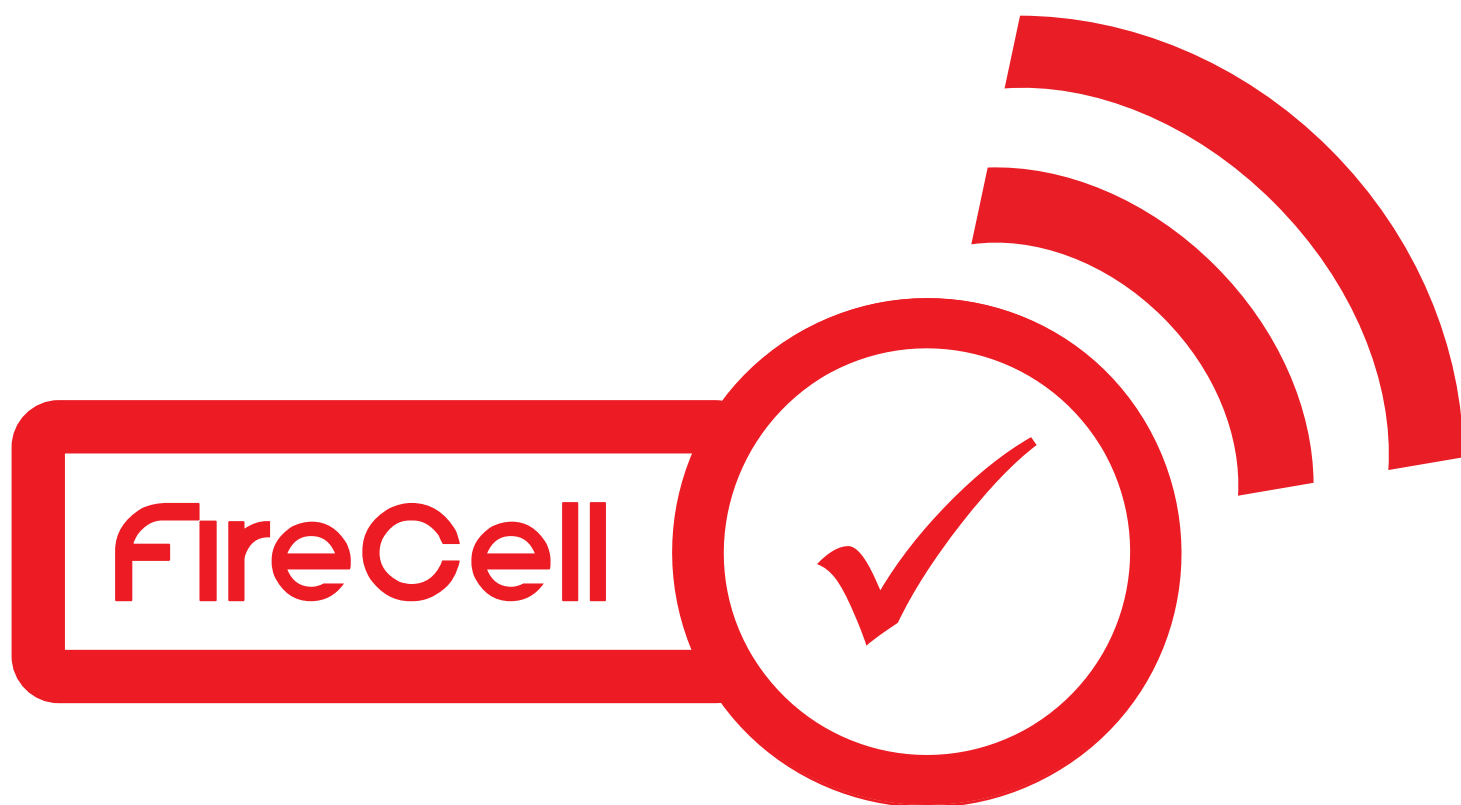



# FireCell Survey Objectives

- Identify Hub and all RCC positions.
- Prove all Hub/RCC wireless communications are above 24dB and indicate a pass.
- Prove all wireless device communications are above 24dB and indicate a pass.
- When proving Wireless Door Control (WDC) communication, check for passes in the proposed final location\*, with the door both open and closed.

\* e.g. replicating final positioning on the bottom of the door / kick plate.

## Typical FireCell System Overview

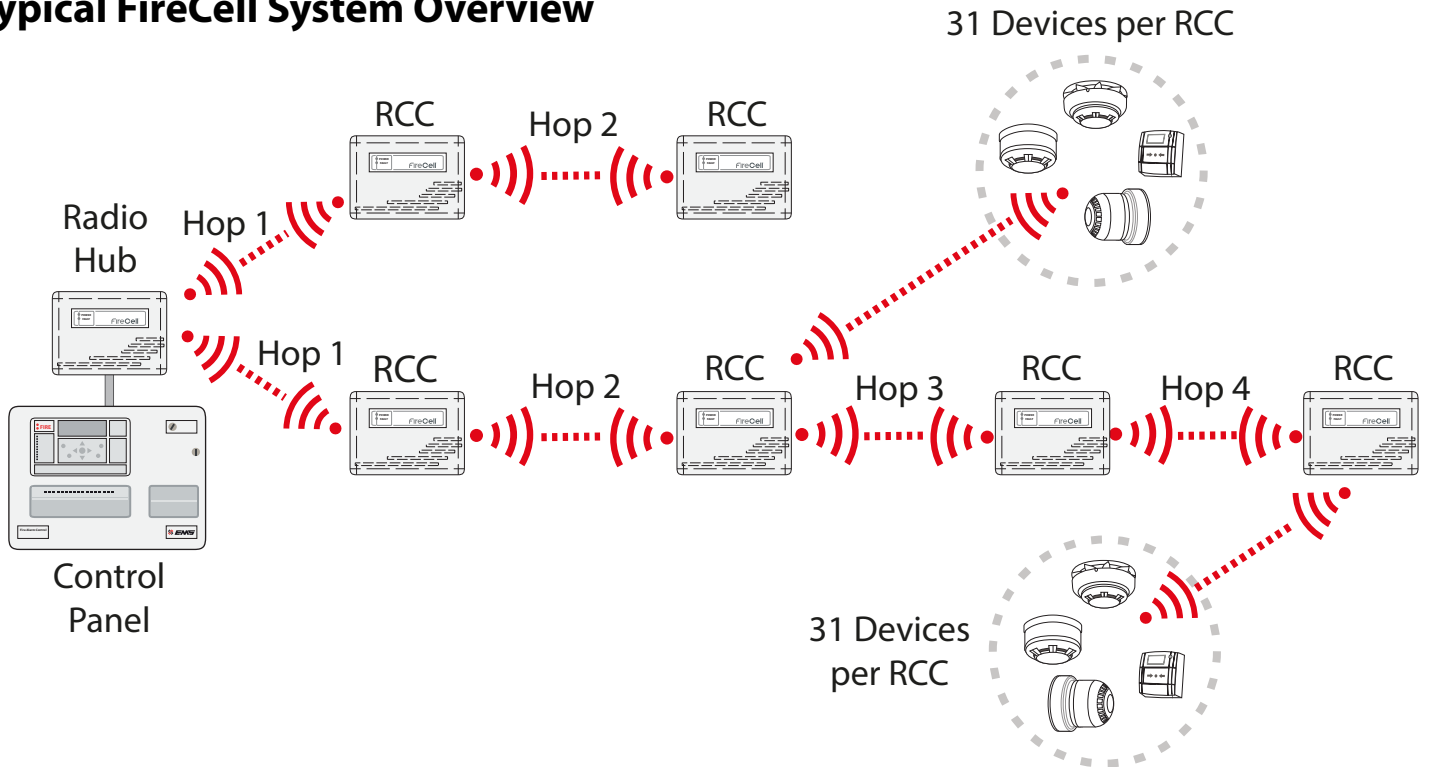

## FireCell System Survey Guidelines

Before you start surveying the premises there are a number of points to take into consideration that will aid the survey. These are as follows:-

1. The Radio Hub and all RCCs must have a valid communication path (pass result).

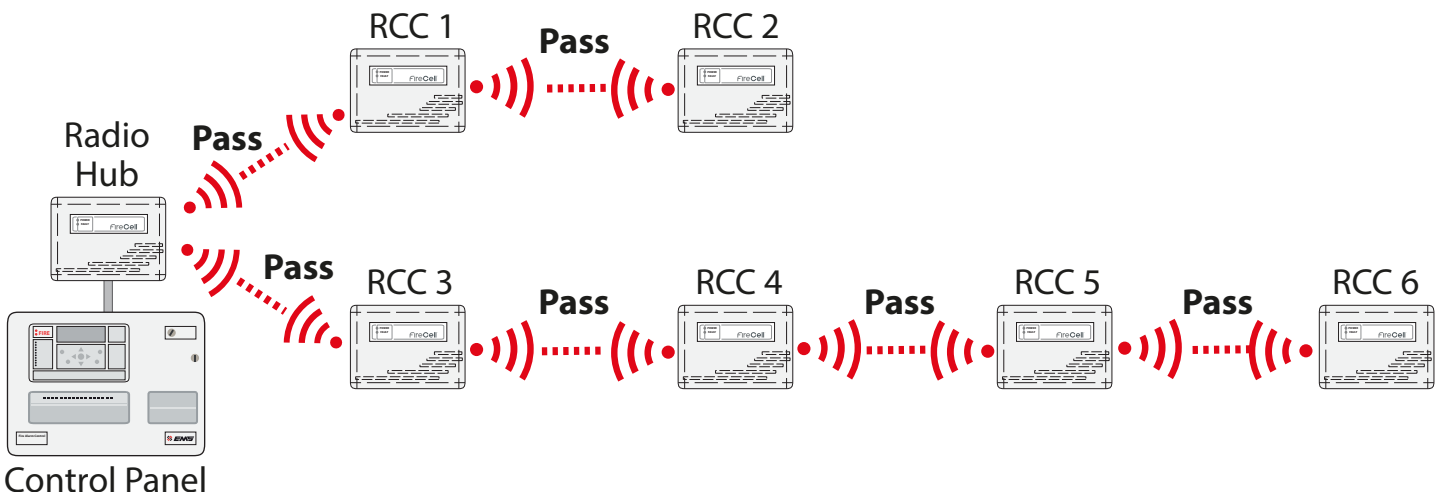

2. All Devices must have valid communication to an RCC (Pass Result).

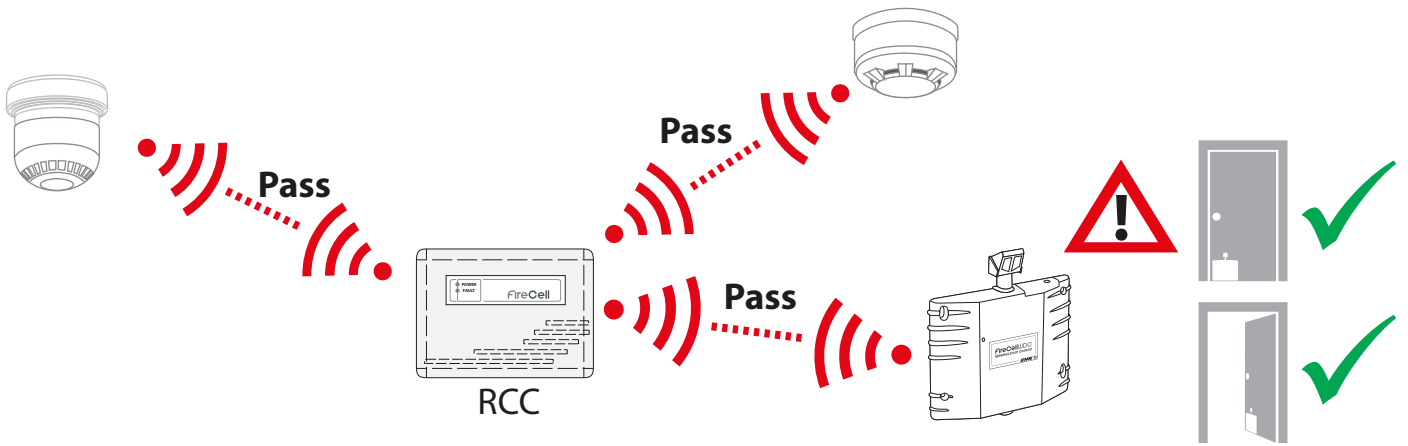

3. Maximum 31 RCCs.

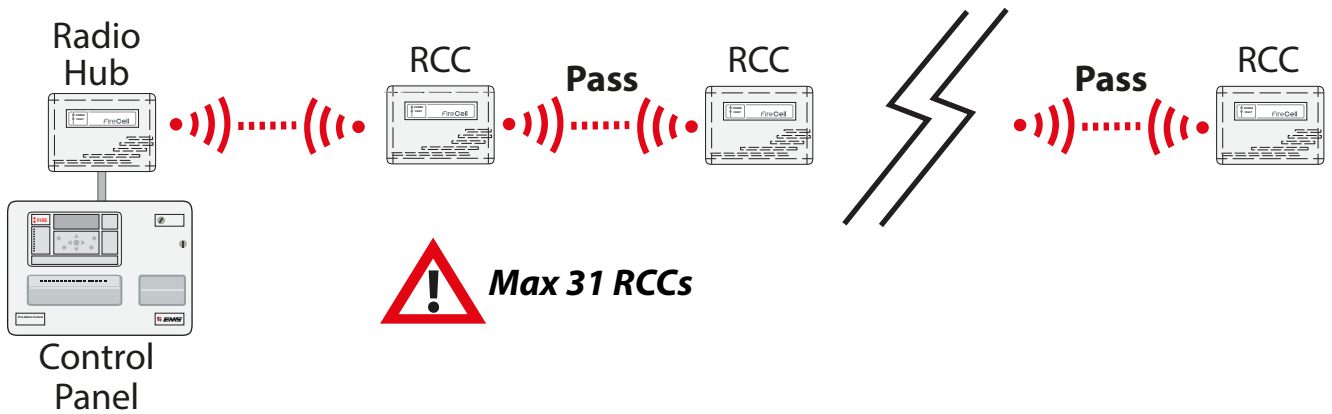

4. A maximum of 4 Hops can be achieved between RCCs to the Hub location.

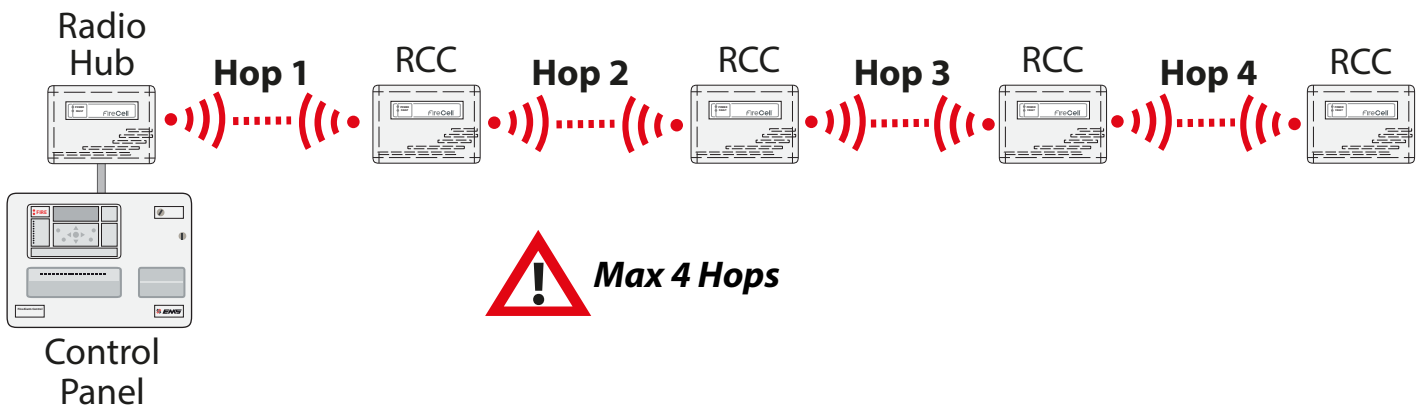



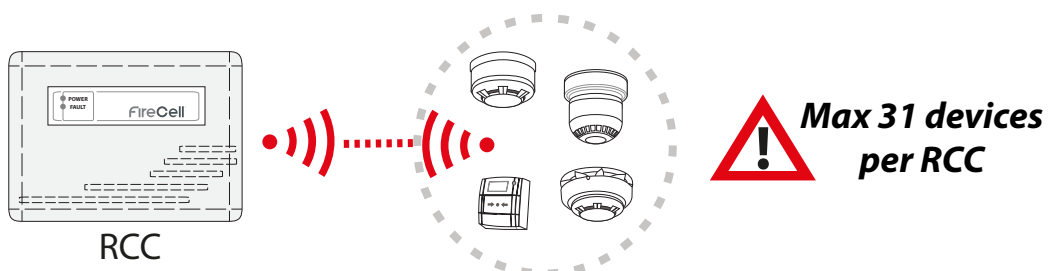

5. Remember, the RCCs can each accommodate a maximum of 31 wireless devices.

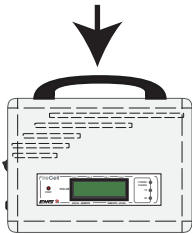
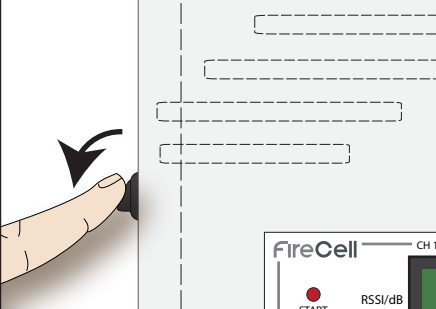

# Step By Step Guide - FireCell Hub/RCC to RCC Surveying

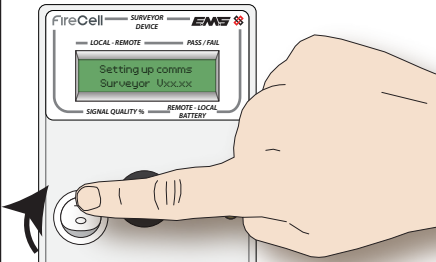
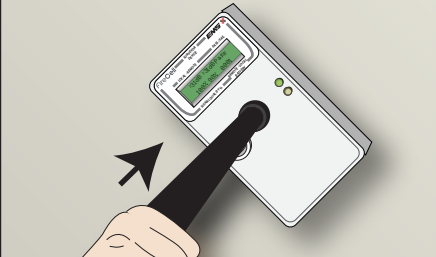
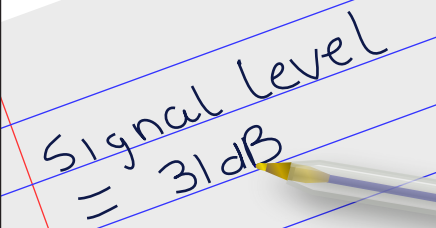
*Note: a Hub/RCC to RCC Survey Form is supplied on page 20.*

<p><b>Step 1.</b> Place the Signal Surveyor in the proposed final position of the Radio Hub.</p>	 <p><b>Surveyor in Hub position</b></p>
<p><b>Step 2.</b> Turn on the Signal Surveyor.</p>	
<p><b>Step 3.</b> Record the background level displayed, for future reference. Refer to the Using the Signal Surveyor section for more information.</p>	
<p><b>Step 4.</b> Turn on the Device Survey Tool.</p>	
<p><b>Step 5.</b> Place the Device Survey Tool against the wall in the proposed final position of the RCC.</p>	
<p><b>Step 6.</b> Record the signal level.</p>	
<p><b>Step 7.</b> Repeat Steps 5-6 for all RCC positions as required.</p> <p> Note: the Surveyor Unit can be moved to an identified RCC location to further expand the coverage. Up to four hops from an RCC to the Hub can be achieved.</p>	 <p><b>Steps 5 to 6</b></p>

# FireCell Hub/RCC to RCC Survey Form

Site \_\_\_\_\_ Customer name \_\_\_\_\_

Survey date \_\_\_\_\_ Company \_\_\_\_\_

Surveyor name \_\_\_\_\_

Fire Panel and Radio Hub.

Location \_\_\_\_\_

**EXAMPLE**

RCC 1  
 Location Main Corridor

Comms Path	Talks to: <b>Hub</b>	┌ dB ┐		┌ % ┐		Pass	Fail
Signal Level		<b>31</b>	<b>31</b>	<b>100</b>	<b>98</b>	<b>✓</b>	
Background Level		<b>7</b>	<b>7</b>				

RCC \_\_\_\_\_

Location \_\_\_\_\_

Comms Path	Talks to:	┌ dB ┐		┌ % ┐		Pass	Fail
Signal Level							
Background Level							

RCC \_\_\_\_\_

Location \_\_\_\_\_

Comms Path	Talks to:	┌ dB ┐		┌ % ┐		Pass	Fail
Signal Level							
Background Level							

RCC \_\_\_\_\_

Location \_\_\_\_\_

Comms Path	Talks to:	┌ dB ┐		┌ % ┐		Pass	Fail
Signal Level							
Background Level							

RCC \_\_\_\_\_

Location \_\_\_\_\_

Comms Path

Talks to:	┌ dB ┐		┌ % ┐		Pass	Fail
-----------	--------	--	-------	--	------	------

Signal Level

Background Level

RCC \_\_\_\_\_

Location \_\_\_\_\_

Comms Path

Talks to:	┌ dB ┐		┌ % ┐		Pass	Fail
-----------	--------	--	-------	--	------	------

Signal Level

Background Level

RCC \_\_\_\_\_

Location \_\_\_\_\_

Comms Path

Talks to:	┌ dB ┐		┌ % ┐		Pass	Fail
-----------	--------	--	-------	--	------	------

Signal Level

Background Level

RCC \_\_\_\_\_

Location \_\_\_\_\_

Comms Path

Talks to:	┌ dB ┐		┌ % ┐		Pass	Fail
-----------	--------	--	-------	--	------	------

Signal Level

Background Level

RCC \_\_\_\_\_

Location \_\_\_\_\_

Comms Path

Talks to:	┌ dB ┐		┌ % ┐		Pass	Fail
-----------	--------	--	-------	--	------	------

Signal Level

Background Level

RCC \_\_\_\_\_

Location \_\_\_\_\_

Comms Path





Talks to:	┌ dB ┐		┌ % ┐		Pass	Fail
-----------	--------	--	-------	--	------	------

Signal Level

Background Level

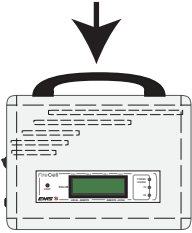
# Step By Step Guide - FireCell Device to RCC Surveying

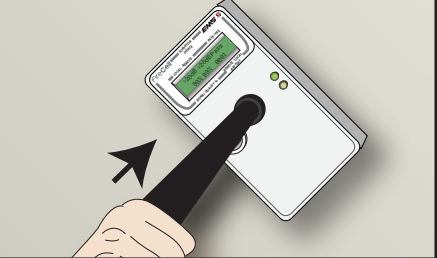
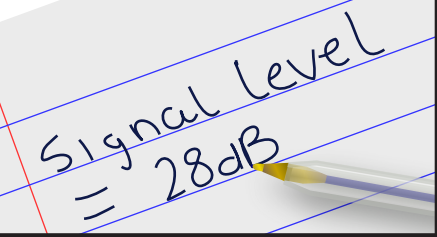
**Note: a Device to RCC Survey Form is supplied on page 23.**

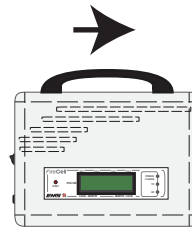
<p><b>Step 8.</b> Device to RCC coverage must now be proven. Place the Signal Surveyor in the proposed final position of the RCC.</p>	 <p><b>Surveyor in RCC position</b></p>
<p><b>Step 9.</b> Record the background level displayed, for future reference. Refer to the Using the Signal Surveyor section for more information.</p>	
<p><b>Step 10.</b> Place the Device Survey Tool against the wall, ceiling or door* in the proposed final position of the wireless device.  <i>* e.g. replicating final positioning on the bottom of the door / kick plate.</i></p>	
<p><b>Step 11.</b> Record the signal level.</p>	
<p><b>Step 12.</b> Repeat Steps 10-11 for all device positions associated with the RCC position.</p>	 <p><b>Steps 8 to 11</b></p>
<p><b>Step 13.</b> If there are multiple RCC positions on site, repeat steps 8 to 12 for each RCC.</p>	 <p><b>Next RCC position</b></p>

# FireCell Device to RCC Survey Form

RCC number \_\_\_\_\_

Additional notes

Device No	Signal Level				Pass	Fail	Comments
	┌─dB─┐		┌─%─┐				
1							
2							
3							
4							
5							
6							
7							
8							
9							
10							
11							
12							
13							
14							
15							
16							
17							
18							
19							
20							
21							
22							
23							
24							
25							
26							
27							
28							
29							
30							
31							



 [www.emsgroup.co.uk](http://www.emsgroup.co.uk)

 +44 (0) 1227 369570

 [enquiries@emsgroup.co.uk](mailto:enquiries@emsgroup.co.uk)



Fire Industry Association



The information contained within this literature is correct at time of publishing. EMS reserves the right to change any information regarding products as part of its continual development enhancing new technology and reliability. EMS advises that any product literature issue numbers are checked with its head office prior to any formal specification being written.