



Fusion

Loop module

Engineers

Guide



Contents

Introduction	3
System Design	3
Handling Precautions	3
Packaging	3
Equipment Familiarisation	4
Fusion Loop Module	5
Loop Module Controls	5
Accessing The Loop Module Menus	5
Menu Structure	6
Fusion Loop Module Address Setting	7
Fusion Loop Module Options	8
Device Status	8
Fault Status	9
Alarm Status	11
Battery Level	13
Signal Level	14
Manual Update	16
Ident	16
Software Version	16
Device Address	17
Add New Address	18
Remove Device	21
Interface Status	21
Fault Status	21
Background Level	22
Fast Test	23
Ident	24
Software Version	24
Audio Detect	24
Batt Smooth	24
Analogue Value 35 Mode	24
Serial Data	24
Radio Channels	24
Changing Radio Channels	25
How To Improve Signal Levels	26
Analogue Value Table	27

Introduction

This manual provides a programming guide for the Fusion Loop Module.

The Fusion Loop Module comprises of a radio transceiver, capable of receiving 31 radio devices. An LCD display is provided along with function buttons to allow programming and diagnostics to be carried out for associated devices.

The Fusion Loop Module is capable of connection to a fire alarm control panel's loop via its loop in and loop out connection terminals. The Fusion Loop Module is addressed on the loop, via its on board 8 way DIP switch. A total of 5 Fusion Loop Modules can be fitted on to a fire alarm control panel's loop.

The Fusion Loop Module is compatible with the full range of EMS FireCell devices.

System Design

All installation work should be carried out in accordance with the survey and system design.

It is recommended that the Fusion Loop Module's peripheral devices are located in accordance with the radio survey and system design. This should be established before installation work commences.

Handling Precautions

General: Care should be taken when handling the Fusion Loop Module. Avoid dropping any of the parts onto hard surfaces, as damage may occur to the case and internal circuitry.

ESD Precautions: The Fusion Loop Module includes components that are susceptible to damage from Electro-Static Discharge (ESD). Permanent damage may be caused to these components through routine handling if precautions are not observed. To reduce the risk of damage from ESD, the following precautions should be observed.

Minimise the handling of PCBs which contain static sensitive devices.

Where handling is unavoidable, always ensure that you have taken adequate earthing precautions. An earthed wrist strap is recommended.

When storing or transporting a "loose" PCB, always use a container, which has been designed and manufactured with ESD protective properties.

Avoid placing static sensitive devices on plastic surfaces, which may increase the risk of a static discharge.

Packaging

All products should be kept in their packaging until they are due to be installed, to minimise the risk of damage. Retain all packaging until the installation activities have been completed. Should any product be found to be surplus to requirements, or require returning to EMS, the original packaging should be used.

Equipment Familiarisation

It is important to establish which devices have been supplied for the installation. Examples of each wireless device are shown below:

Wireless Infrastructure

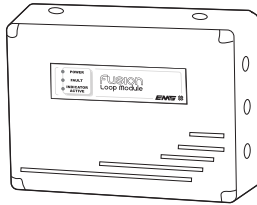

Fusion Loop Module

Wireless Call Point / IO Unit

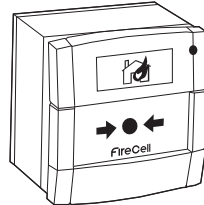

Wireless Call Point



Wireless Input / Output Unit

Wireless Detectors

Note: Detector and Detector Wireless Bases shown below, can be mixed and matched as required.

Optical Detector



Rate of Rise A1R Heat Detector

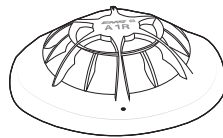

Fixed CS Heat Detector

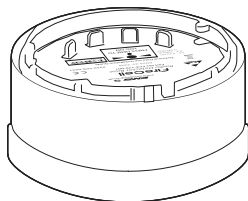
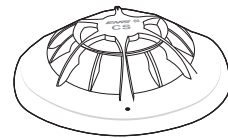

Detector Wireless Base

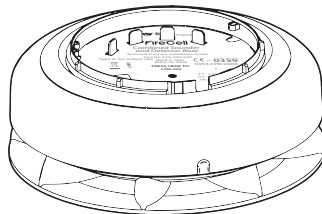

Sounder Detector Wireless Base

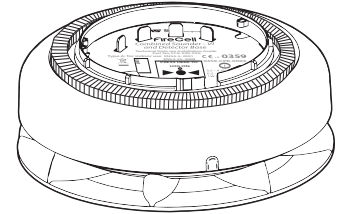

Sounder Detector with Visual Indicator Wireless Base

Audio Visual Devices

Note: All Audio Visual Elements shown below, can be fitted to the Sounder Wireless Base as required.

Sounder

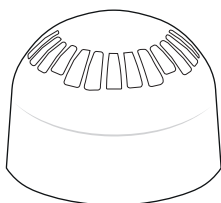

Ceiling Sounder Beacon

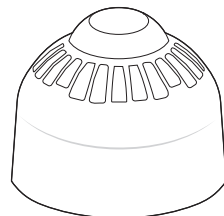

Wall Sounder Beacon

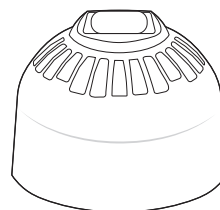

Sounder / Visual Indicator

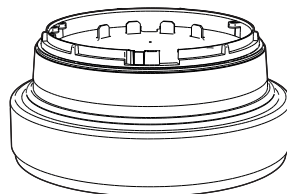
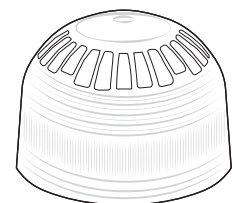

Fusion Loop Module

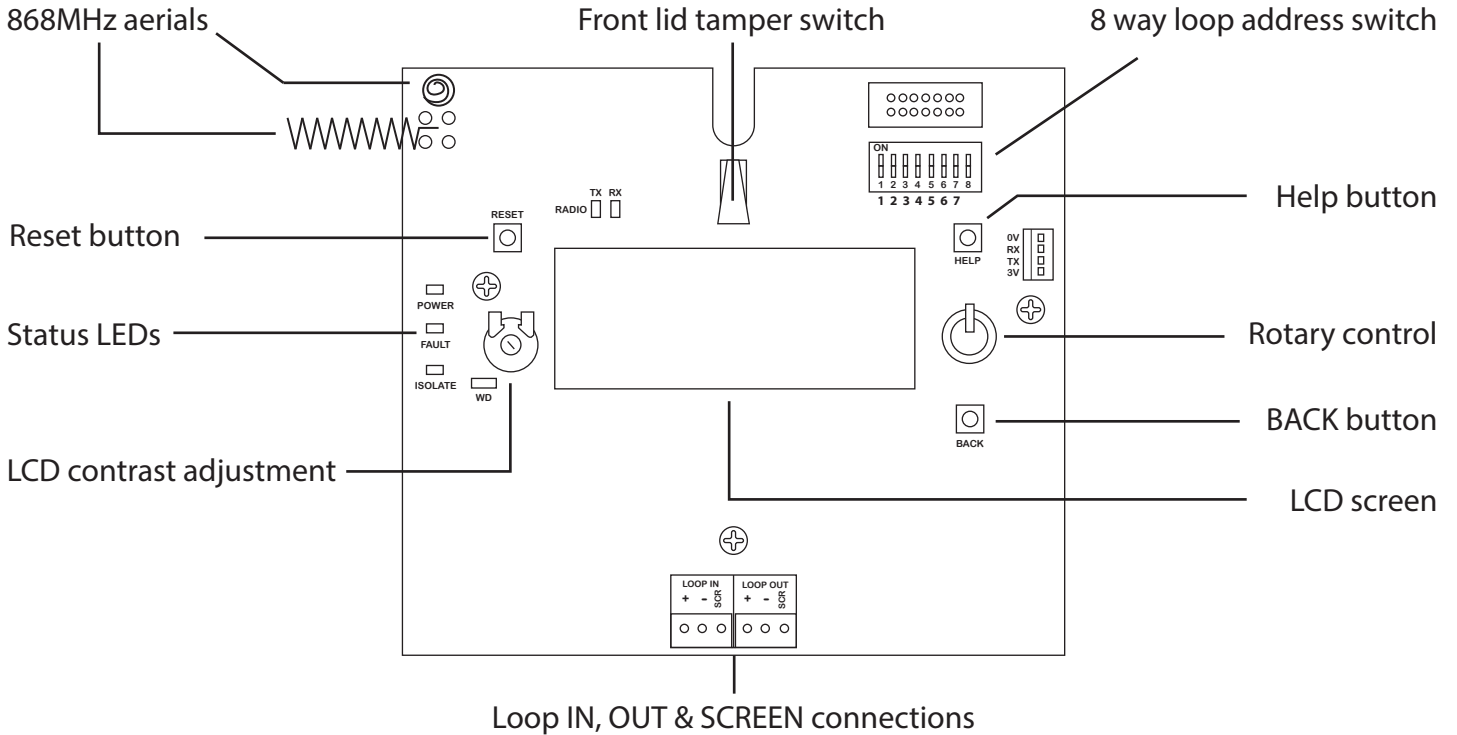

Loop Module Controls

The front display of the loop module will show the number of devices that are allocated to the interface along with the total number of Alarms and Faults currently outstanding for devices allocated to the module. An example display will show:

```
DEV01 AL00 FT00
```

DEV01 = total number of devices on the system, between 00 & 31.

AL00 = total number of devices in alarm condition, between 00 & 31.

FT00 = total number of devices in fault condition, between 00 & 31.

Accessing The Loop Modules Menus

To access the Users menus from the front display screen, follow the steps listed below:

```
DEV01 AL00 FT00
```

Press the rotary control. The display will change to show:

```
Device Status
```

The Menu structure can be viewed by scrolling through the menu by turning the rotary control. Entry into the required menu is achieved by locating the required menu on the display and pressing the rotary control. Exiting from a menu option is achieved automatically after 30 seconds or by pressing the BACK button located on the loop module.

Menu Structure

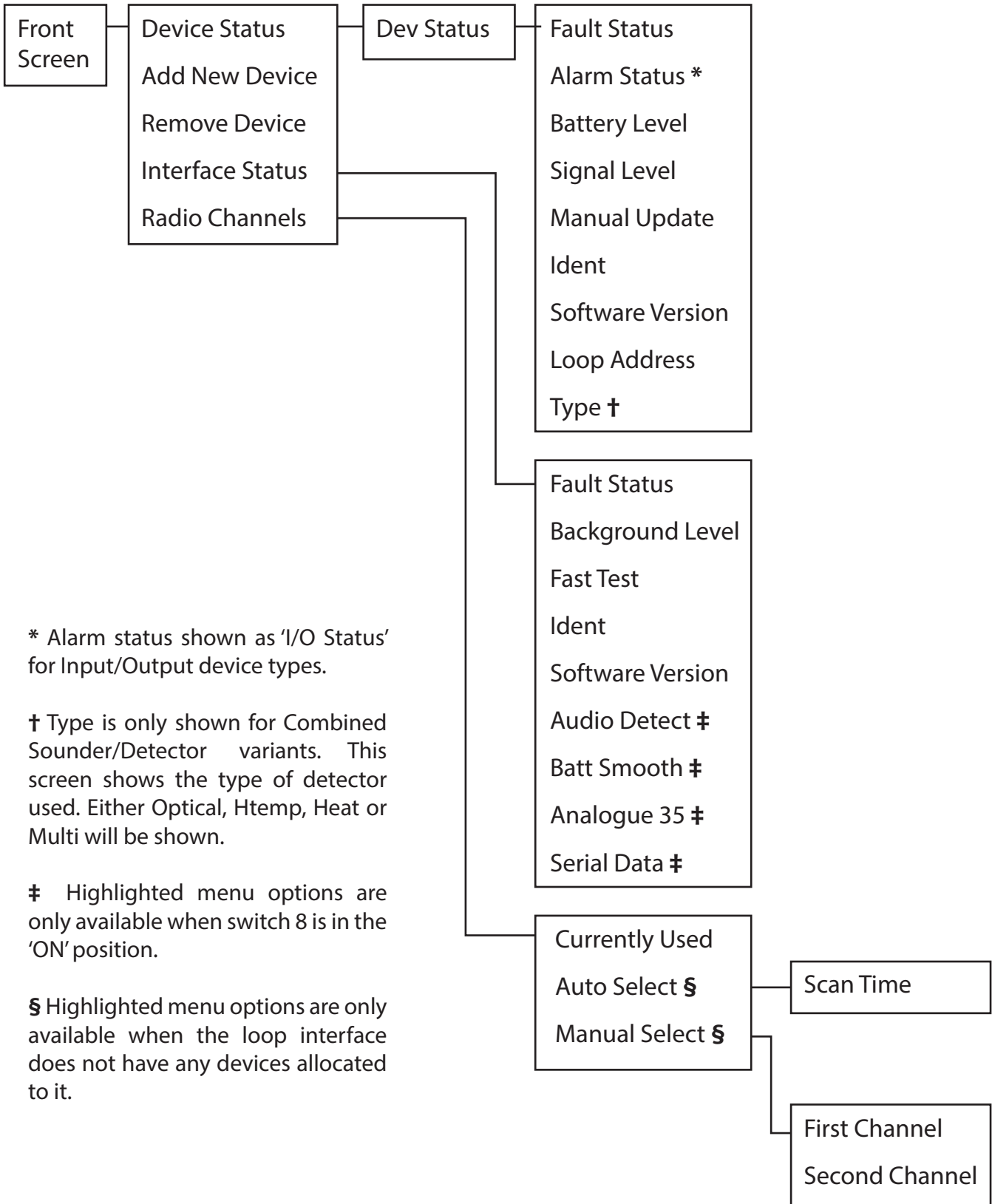

* Alarm status shown as 'I/O Status' for Input/Output device types.

† Type is only shown for Combined Sounder/Detector variants. This screen shows the type of detector used. Either Optical, Htemp, Heat or Multi will be shown.

‡ Highlighted menu options are only available when switch 8 is in the 'ON' position.

§ Highlighted menu options are only available when the loop interface does not have any devices allocated to it.

Fusion Loop Module Address Setting

The address number is set using the on board 8 way switch. Available selections are shown below:

DIL Switch Setting	DIL Switch Setting	DIL Switch Setting	DIL Switch Setting	DIL Switch Setting
addr 1.....8	addr 1.....8	addr 1.....8	addr 1.....8	addr 1.....8
1 10000000	11 11010000	21 10101000	31 11111000	41 10010100
2 01000000	12 00110000	22 01101000	32 00000100	42 01010100
3 11000000	13 10110000	23 11101000	33 10000100	43 11010100
4 00100000	14 01110000	24 00011000	34 01000100	44 00110100
5 10100000	15 11110000	25 10011000	35 11000100	45 10110100
6 01100000	16 00001000	26 01011000	36 00100100	46 01110100
7 11100000	17 10001000	27 11011000	37 10100100	47 11110100
8 00010000	18 01001000	28 00111000	38 01100100	48 00001100
9 10010000	19 11001000	29 10111000	39 11100100	49 10001100
10 01010000	20 00101000	30 01111000	40 00010100	50 01001100
51 11001100	61 10111100	71 11100010	81 10001010	91 11011010
52 00101100	62 01111100	72 00010010	82 01001010	92 00111010
53 10101100	63 11111100	73 10010010	83 11001010	93 10111010
54 01101100	64 00000010	74 01010010	84 00101010	94 01111010
55 11101100	65 10000010	75 11010010	85 10101010	95 11111010
56 00011100	66 01000010	76 00110010	86 01101010	96 00000110
57 10011100	67 11000010	77 10110010	87 11101010	97 10000110
58 01011100	68 00100010	78 01110010	88 00011010	98 01000110
59 11011100	69 10100010	79 11110010	89 10011010	99 11000110
60 00111100	70 01100010	80 00001010	90 01011010	100 00100110
101 10100110	106 01010110	111 11110110	116 00101110	121 10011110
102 01100110	107 11010110	112 00001110	117 10101110	122 01011110
103 11100110	108 00110110	113 10001110	118 01101110	123 11011110
104 00010110	109 10110110	114 01001110	119 11101110	124 00111110
105 10010110	110 01110110	115 11001110	120 00011110	125 10111110
				126 01111110

Fusion Loop Module Menu Options

Device Status

This function allows the current status of the allocated devices on the loop module to be viewed (maximum of 31 devices). The devices are shown in the menu indicating their loop address number, it's logged on status and the device type. Further information on the device can be obtained by pressing the rotary control. This enables the following details to be viewed:- Fault status, Alarm Status, Battery Level, Signal Level, unique 5 digit ident number and also allows a manual signal level update to take place.

A typical display is shown below:



Addr 067 L Optic

Addr 067 = device loop address, between 00 & 126.

L = device is logged on and in normal condition.

Alternative are as follows:

L = Combined Sounder/Detector in a normal condition.

Note: this device will hold and show two loop addresses.

(The first for its sounder and the next for its detector).

! = Fault present.

🔥 = Fire present.

🚨 = Pre alarm present.

Optic = indicates the device type.

Available options are as follows:

Optic = Optical Detector

Sound = Sounder Device

I/O = Input/Output Device

Radio = Loop Interface Module

Multi = Multi-sensor Detector

Heat = Heat Detector

H Temp = High Temperature Detector

MCP = Manual Callpoint

Cmb = Combined Sounder / Detector

??? = Unknown Device

Note: A combined sounder / detector utilises two sequential addresses on the system. The first address is for the sounder and the second address is for the detector head.

An example is shown on the display:



Addr 002L003 Cmb

Further device status information on the displayed device is available by pressing the rotary control . This allows the following menus to be viewed (*see overleaf*).

Fault Status

This menu shows detailed information on the fault status of the device. If multiple faults are outstanding for a device then by turning the rotary control they can be individually viewed. The available fault descriptions are shown below:]

No Fault Present – this description indicates that no fault condition is present and that the device is operating correctly. The analogue value seen on the fire control panel from the device in normal status will vary depending on the signal strength readings. The range of values are shown below:

	Signal Strength GOOD	Signal Strength MEDIUM	Signal Strength LOW	Signal Strength CAUTION
Detector	25	20	14	14
Manual Call Point	16	16	14	14
Sounder	16	16	14	14
Input/Output Device	16	16	14	14

In Tamper – this description indicates that the device's tamper switch is not currently making contact against the ceiling or wall mounting plate. The analogue values seen on the fire control panel for devices in this state are shown below:

	Analogue Value
Detector	4
Manual Call Point	4
Sounder	4
Input/Output Device	4

Head Missing – this indicates that the detector (head) is not currently fitted to the detector's wireless base. The analogue values seen on the fire control panel for devices in this state are shown below:

	Analogue Value
Detector	2
Manual Call Point	N/A
Sounder	N/A
Input/Output Device	N/A

Sounder Missing – this indicates that the sounder, strobe only or sounder/strobe (head) is not currently fitted on the sounder's wireless module. The analogue values seen on the fire control panel for devices in this state are shown below:

	Analogue Value
Detector	N/A
Manual Call Point	N/A
Sounder	3
Input/Output Device	N/A

Signalling Fault – this indicates that there has currently not been any communication between the device and the loop module for 300 seconds. This is indicated as an analogue value of 0 on the fire alarm control panel.

This will be shown on the fire control panel as if the device had been removed from the system, as it does not respond to polls on the loop, i.e. Disconnect fault. The analogue values seen on the fire control panel for devices in this state are shown below:

	Analogue Value
Detector	0
Manual Call Point	0
Sounder	0
Input/Output Device	0

Battery Fault – this indicates that the device has either a low battery and has a minimum operational life of 7- 30 days or has a battery missing. The analogue values seen on the fire control panel for devices in this state are shown below:

	Analogue Value
Detector	7
Manual Call Point	7
Sounder	7
Input/Output Device	7

The analogue value seen on the fire control panel for devices with a battery missing is:

	Analogue Value
Detector	0
Manual Call Point	0
Sounder	0
Input/Output Device	0

This will not be shown on the fire control panel as if the device had been removed from the system like the signalling fault previously described, therefore differentiating between the two states.

Head Dirty – this shows that the device has a detector head reading which is deemed as dirty/contaminated. The analogue values seen on the fire control panel for devices in this state are shown below:

	Analogue Value
Detector	35
Manual Call Point	N/A
Sounder	N/A
Input/Output Device	N/A

No Sndr Audio – this indicates that a sounder device has given no audio output or a low audio output when sounding. This is selectable via a DIP switch on the sounder head and must be disabled when using strobe only devices. The analogue values seen on the fire control panel for devices in this state are shown below:

	Analogue Value
Detector	N/A
Manual Call Point	N/A
Sounder	1
Input/Output Device	N/A

Head Fault – this indicates that a detectors head has a fault, i.e. no communication between the head and the radio base. The analogue values seen on the fire control panel for devices in this state are shown below:

	Analogue Value
Detector	1
Manual Call Point	N/A
Sounder	N/A
Input/Output Device	N/A

Short Circuit – this indicates that an input has a short circuit wiring fault. The analogue values seen on the fire control panel for devices in this state are shown below:

	Analogue Value
Detector	N/A
Manual Call Point	N/A
Sounder	N/A
Input/Output Device	4

Open Circuit – this indicates that an input has a short circuit wiring fault. The analogue values seen on the fire control panel for devices in this state are shown below:

	Analogue Value
Detector	N/A
Manual Call Point	N/A
Sounder	N/A
Input/Output Device	4

Alarm Status

This menu shows information on the current alarm status of the device. The available alarm descriptions are described below:

No Alarm Present – this indicates the device is currently not in an alarm or pre-alarm condition.

In Fire – this indicates the device is currently in a fire alarm condition. The analogue values seen on the fire control panel for devices in this state are shown below:

	Analogue Value
Detector	85
Manual Call Point	64
Sounder	N/A
Input/Output Device	N/A

In Pre-Alarm – this indicates the device is currently in a Pre-alarm condition. The analogue values seen on the fire control panel for devices in this state are shown below:

	Analogue Value
Detector	50
Manual Call Point	N/A
Sounder	N/A
Input/Output Device	N/A

I/O Status – this menu replaces the Alarm Status menu for Input/Output devices and shows information on the current status of the device’s two inputs and the two outputs. The available status descriptions are described below:

IN: 0-0 – this indicates that inputs 1 and 2 are in the open (normal) state.

IN: 1-0 – this indicates that input 1 is in the closed (activated) state.

IN: 0-1 – this indicates that input 2 is in the closed (activated) state.

IN: 1-1 – this indicates that inputs 1 and 2 are in the closed (activated) state.

OUT: 0-0 – this indicates that outputs 1 and 2 are in the open (normal) state.

OUT: 1-0 – this indicates that output 1 is in the closed (activated) state.

OUT: 0-1 – this indicates that output 2 is in the closed (activated) state.

OUT: 1-1 – this indicates that outputs 1 and 2 are in the closed (activated) state.

The analogue values seen on the fire control panel for devices with inputs in a normal state are shown below:

	Analogue Value
Detector	N/A
Manual Call Point	N/A
Sounder	N/A
Input/Output Device	16 *

The analogue values seen on the fire control panel for devices with inputs in a closed state are shown below:

	Analogue Value
Detector	N/A
Manual Call Point	N/A
Sounder	N/A
Input/Output Device	16 *

* The Analogue value for the normal and closed input status is shown in relation to the devices signal strength. Therefore this can vary between 16, 14 or 13.

Battery Level

This menu shows information on the battery pack status for a device. A device has 2 packs. The status of each of these can be viewed from this menu. The status of the pack is updated whenever there is a status change or automatically updated every 6 hours. The available battery descriptions are described below:

Pack 1 OK – this indicates a good battery voltage is present in pack 1. This is represented by displaying a full battery icon.

Pack 1 Warning – this indicates the battery voltage is low in pack 1 and is a 30 day warning indication. The batteries must be changed on the device within 30 days for continued reliable operation. This is represented by displaying a half full battery icon.

Pack 1 Low – this indicates the battery voltage is low in pack 1 and is a 7 day warning indication. The batteries must be changed on the device within 7 days for continued reliable operation. This is represented by displaying an empty battery icon.

Pack 1 Missing – this indicates a battery from pack 1 is missing. The battery must be inserted on the device for continued reliable operation. This is represented by displaying an X symbol.

Pack 2 OK – this indicates a good battery voltage is present in pack 2. This is represented by displaying a full battery icon.

Pack 2 Warning – this indicates the battery voltage is low in pack 2 and is a 30 day warning indication. The batteries must be changed on the device within 30 days for continued reliable operation. This is represented by displaying a half full battery icon.

Pack 2 Low – this indicates the battery voltage is low in pack 2 and is a 7 day warning indication. The batteries must be changed on the device within 7 days for continued reliable operation. This is represented by displaying an empty battery icon.

Pack 2 Missing – this indicates a battery from pack 2 is missing. The battery must be inserted on the device for continued reliable operation. This is represented by displaying an X symbol.

Signal Level

This menu shows information on the two signalling channels used by the loop interface in both directions, as the devices are bi-directional.

To check the signal levels for a device on the loop module, follow the steps below:

With the loop interface in its normal state the screen will display:

```
DEV01 AL00 FT00
```

Press the rotary control and the screen will now display:

```
Device Status
```

Press the rotary control and the screen will display the first device, i.e.

```
Addr 067 L Optic
```

Turn the rotary control until the device in question is displayed and press the rotary control. The display will show:

```
Fault Status
```

Turn the rotary control until the screen displays:

```
Signal Level
```

Press the rotary control and the screen will now display:

```
Ch1 LI←D 100
```

Turn the rotary control to view signals from the device to the loop interface (LI←D) and from the loop interface to the device (LI→D):

```
Ch1 LI→D 100
```

When all levels have been checked, press the BACK button to return to the normal front screen display.

```
DEV01 AL00 FT00
```

The received signal strength at the loop interface from the device is shown as an LI←D level, indicating the signal that has been sent from the device to the loop interface. The LI←D level is updated on every poll response (123 seconds). The forward signal strength received at a device from the loop interface is shown as an LI→D level, indicating the signal that has been sent from the loop interface to the device. The LI→D level is updated every 6 hours, or when requested manually by selecting the 'Manual Update' option from the menu.

Ch 1 LI←D – this indicates the received signal strength at the loop interface from the device on the first frequency channel used by the system. A level from 100 -0 is shown to indicate the levels. A table with additional signal level details is shown at the end of this section.

Ch 2 LI←D – this indicates the received signal strength at the loop interface from the device on the second frequency channel used by the system. A level from 100 -0 is shown to indicate the levels. A table with additional signal level details is shown at the end of this section.

Ch 1 LI→D – this indicates the forward signal strength received at the device from the loop interface on the first frequency channel used by the system. A level from 100 -0 is shown to indicate the levels. A table with additional signal level details is shown at the end of this section.

Ch 2 LI→D – this indicates the forward signal strength received at the device from the loop interface on the second frequency channel used by the system. A level from 100 -0 is shown to indicate the levels. A table with additional signal level details is shown at the end of this section.

The individual devices have signal levels available for both of their operating channels (Ch1 and Ch2) and also for both directions (Loop interface to Device (LI →D) and Device to Loop Interface (LI ←D)) as the devices are bi-directional. The signal levels shown range from 100 - 0 with 100 being the highest signal to 0 where no signal is being seen, as shown below;

100	Indicates a GOOD signal level
90	Indicates a GOOD signal level
80	Indicates a GOOD signal level
70	Indicates a GOOD signal level
60	Indicates a GOOD signal level
50	Indicates a GOOD signal level
40	Indicates a MEDIUM signal level
30	Indicates a LOW signal level
20	Indicates a CAUTION signal level
10	Indicates a CAUTION signal level
0	Indicates NO SIGNAL level received

An algorithm incorporating both channels and the channels background is employed to indicate the analogue values displayed at the associated control panel and therefore determining the devices signal strength. This is shown in the table below.

Analogue Value	Device Type	Device Signal Level Strength
0	All devices	NO SIGNAL level received - device missing
13	All devices	Radio signal level CAUTION
14	All devices	Radio signal level LOW
16	Callpoint, Sounder and I/O device	Radio signal level GOOD/MEDIUM
20	Detector	Radio signal level MEDIUM
25	Detector	Radio signal level GOOD

The device to loop interface information is updated every time the device responds to a poll which is every 123 seconds. The loop module to device information is automatically updated every 6 hours or if a manual update is requested.

The minimum recommend level is 50 points or above on each channel.

Manual Update

This menu when entered will automatically send signals from the loop module to the individual device and ask for its current signal level status to be transmitted back to the loop module. This will then automatically update the Signal level fields for the device. If a signal level field is still awaiting an update from a channel 0 will be shown in the field. Viewing signal levels is covered in the 'Signal Level' section of this manual.

To manually update the signal levels for a device on the loop module, follow the steps below:

With the loop interface in its normal state the screen will display:

```
DEV01 AL00 FT00
```

Press the rotary control and the screen will now display:

```
Device Status
```

Press the rotary control and the screen will display the first device, i.e.

```
Addr 067 L Optic
```

Turn the rotary control until the device in question is displayed and press the rotary control. The display will show:

```
Fault Status
```

Turn the rotary control until the screen displays:

```
Manual Update
```

Press the rotary control and the screen will now display:

```
Updating
```

The display will automatically return the 'Manual Update' screen:

```
Manual Update
```

To check the latest signals received for the individual device enter the signal level menu as described in previous section.

When all levels have been checked, press the BACK button to return to the normal front screen display.

```
DEV01 AL00 FT00
```

Ident

This menu shows the device's unique 5 digit identification number.

Software Version

This menu shows the device's current software version.

Device Address

This menu allows you to view and change the device address numbers, if required.

To change the device address on the loop module, follow the steps below:

With the loop interface in its normal state the screen will display:



```
DEV01 AL00 FT00
```

Press the rotary control and the screen will now display:



```
Device Status
```

Press the rotary control and the screen will display the first device, i.e.



```
Addr 003 L Optic
```

Turn the rotary control until the device in question is displayed and press the rotary control. The display will show:



```
Fault Status
```

Turn the rotary control until the screen displays:



```
Loop Address 003
```

Press the rotary control and the screen will now display:



```
Loop Address 004
```

Turn the rotary control until the desired address is shown, then click the rotary control confirm selection:



```
Loop Address 005
```

When all levels have been checked, press the BACK button to return to the normal front screen display.



```
DEV01 AL00 FT00
```

Type

This menu option is available for combined sounder detectors and shows the type of sensor fitted.

Variants are 'Optical' for optical detectors, 'Htemp' for class CS (fixed temp) heat detectors, 'Heat' for class AIR (rate-of-rise) detectors and 'Multi' for multisensor detectors.

Add New device

This menu allows a total of 31 wireless devices to be added to the Loop Module. The devices must be powered prior to adding them to the system, *i.e. batteries inserted and power links in place.*

When adding the devices to the Loop Module, the device confirmation LEDs will also illuminate. The location of device log on buttons, power jumper connections and confirmation LEDs are shown overleaf.

Note: The Loop Modules Radio Channels can only be changed whilst there are no devices added to the system. See the 'Changing Radio Channels' section for more info.

To add a device onto the Loop Module, with the device at the Loop Module, follow the steps below:

With the loop interface in its normal state the screen will display:



```
DEV01 AL00 FT00
```

Press the rotary control and the screen will now display:



```
Device Status
```

Turn the rotary control until the screen displays:



```
Add New Device
```

Press the rotary control and the screen will now display:



```
Press Dev Log On
```

Press the device's log on button for 2 seconds (*the device's confirmation led will illuminate*). The screen will now display:



```
Add Dev xxxxx N?
```

If the ident shown does not match the ident of the new device to be added then press the rotary control when the above Add Dev xxxxx N? display is shown. This will return the display to the previous menu.

If the device ident shown is correct, turn the rotary control until the screen displays:



```
Add Dev xxxxx Y?
```

Press the rotary control and the screen will display:



```
Addine
```

Followed by:



```
Address 002
```

Turn the rotary control, until the desired device address is shown:



```
Address 007
```

Press the rotary control to confirm the device address. The screen will display:



```
Detector Added
```

Press the BACK button, to return to the front display:



```
DEV02 AL00 FT00
```

Equipment Familiarisation

Wireless Call Point

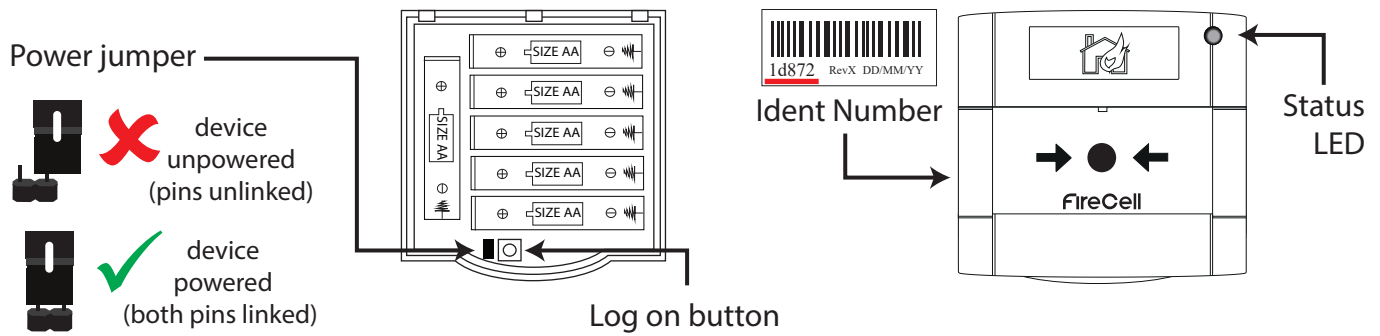

Wireless Detector Base

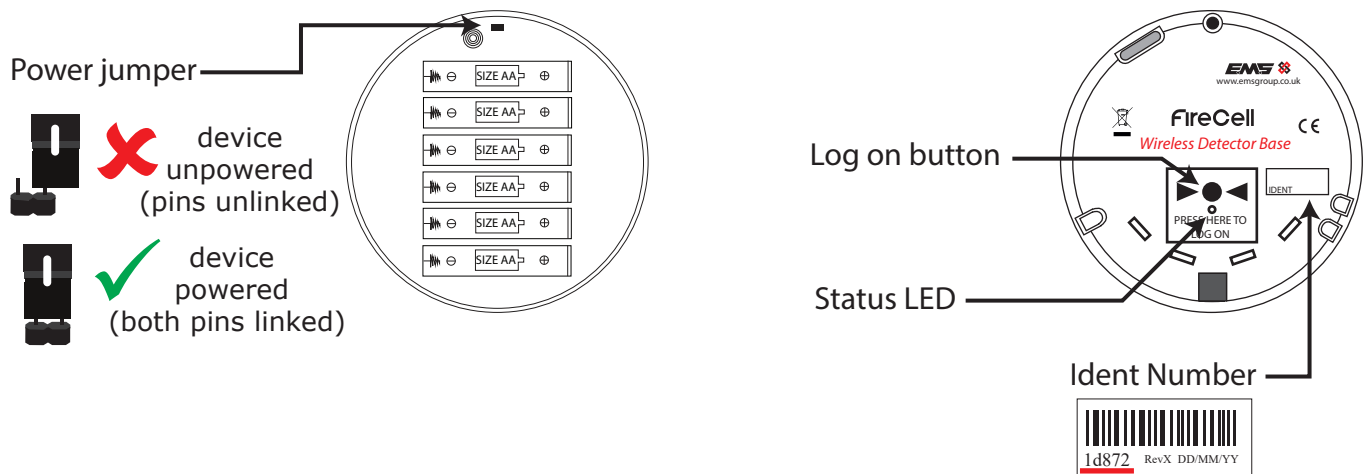

Wireless Sounder & Detector Base

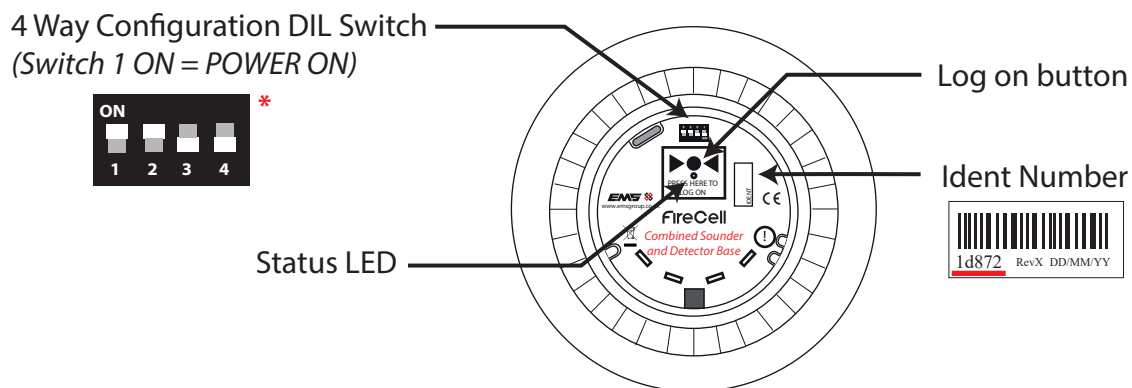

* Note; as viewed at 180 degree device rotation.

Wireless Sounder Base

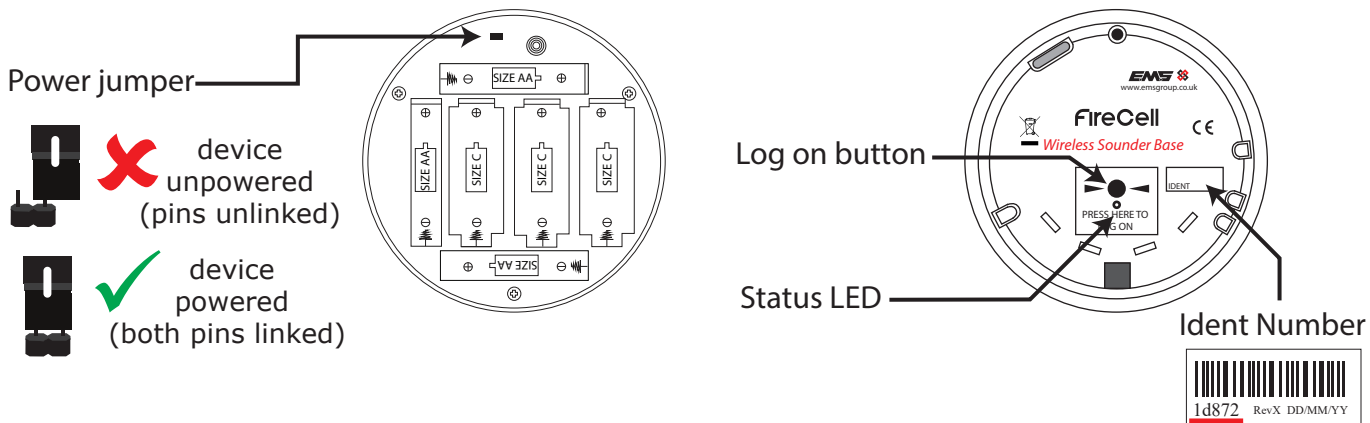

Wireless Input / Output Unit

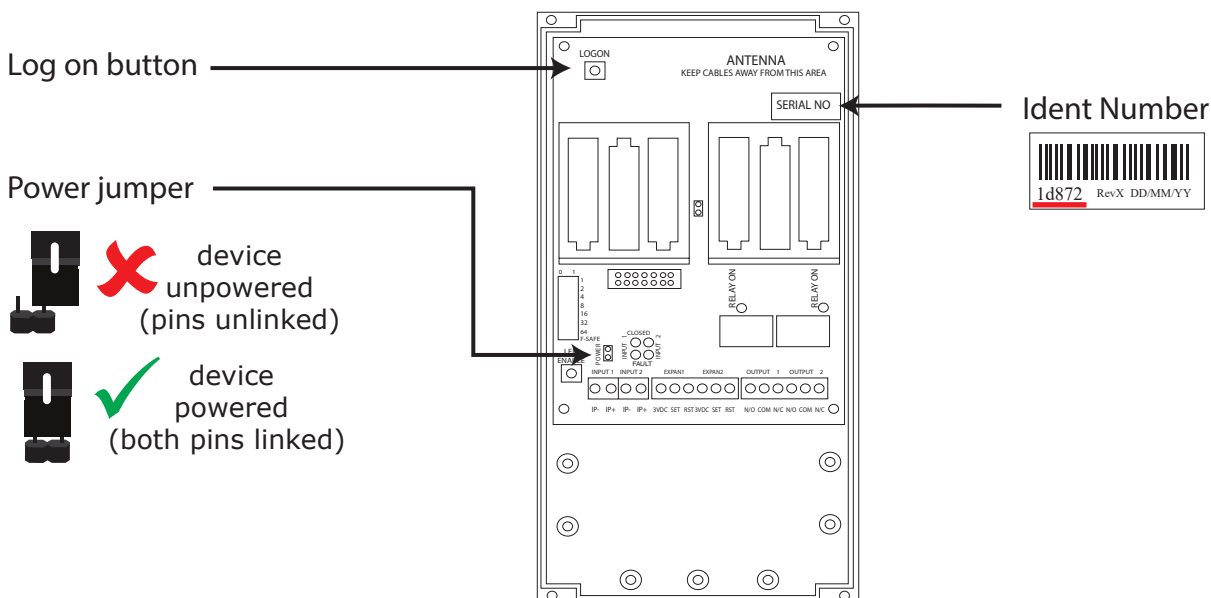

Remove device

This menu allows removal of devices from the loop module.

To change the device address on the loop module, follow the steps below:

With the loop interface in its normal state the screen will display:

```
DEV02 AL00 FT00
```

Press the rotary control and the screen will now display:

```
Device Status
```

Turn the rotary control until the screen displays:

```
Remove Device
```

Press the rotary control and the screen will display the first device, i.e.

```
L 01 12345 Optic
```

Note: Pressing the 'HELP' button at this point displays the devices loop address, for identification purposes.

Turn the rotary control until the screen displays the device that is to be removed and press the rotary control. The screen will now display:

```
Remove xxxxx N ?
```

Note: If the ident shown does not match the ident of the device to be removed, press the rotary control when the above Remove xxxxx N? display is shown. This will return the display to the previous menu.

Confirm the device ident number displayed is the same as located on the device. If correct, turn the rotary control until the screen displays:

```
Remove xxxxx Y ?
```

Press the rotary control and the screen will now show confirmation of the device removal, i.e.

```
01 Removed Optic
```

Press the BACK button, to return to the normal front screen display:

```
DEV01 AL00 FT00
```

Interface status

This function allows the current status of the loop module to be viewed. Available options are:

Fault status, Background level, Fast test, Unique ident number and Software version.

Additional options are available by the selection of address switch 8 (see the 'Menu Structure' section). More details on these options is available by pressing the rotary control on the required item. This allows the following menus to be viewed:

Fault Status

This menu when entered shows detailed information on the fault status of the interface. If multiple faults are outstanding for the interface then by turning the rotary control they can be individually viewed. The available fault descriptions are described overleaf:

No Fault Present – this indicates that the interface is not in any fault and is operating normally. The analogue values seen on the fire control panel for devices in this state is shown below:

	Analogue Value
Loop Interface	16

Aerial Tamper– this indicates that the aerial on the loop module is not attached or damaged. The analogue values seen on the fire control panel for devices in this state is shown below:

	Analogue Value
Loop Interface	4

Ch1RFI Det – this indicates that a radio frequency interference signal has been detected on radio channel 1 that the system is operating on.

Ch2 RFI Det – this indicates that a radio frequency interference signal has been detected on radio channel 2 that the system is operating on.

The analogue value seen on the fire control panel for when both channel 1 and channel 2 are in this state, is shown below:

	Analogue Value
Loop Interface	5

Background Level

This menu shows the background radio signal level on the two signalling channels used by the loop module. The available background level descriptions are described below:

Ch 1 – this indicates the background level at the loop interface on the first frequency channel used by the system. A range from 100 – 0 is shown to indicate the levels, a table of which is shown below.

Ch 2 – this indicates the background level at the loop module on the second frequency channel used by the system. A range from 100 – 0 is shown to indicate the levels, as shown below:

100	Indicates a VERY HIGH background level
75	Indicates a HIGH background level
50	Indicates a MEDIUM background level
25	Indicates a LOW background level
0	Indicates a GOOD background level

Fast Test

This option allows detectors to be put into their fast test mode. When the fast test mode is selected, the detectors mode is changed and their sensitivity is raised, therefore allowing them to be more easily tested. A LED on the unit will flash every second to indicate the detector is in this mode. The test is time limited, with time options ranging from 1 minute to 30 minutes, whilst a timer is present on the display, showing the time remaining. If a fire alarm is seen during this period, the time reverts back to the selected time duration. If no fire events are seen within this time duration, the fast test mode is automatically cancelled and the detectors return to their normal mode of operation.

To enable fast test facility on the Loop Module, follow the steps below:

With the loop interface in its normal state the screen will display:



```
DEV02 AL00 FT00
```

Press the rotary control and the screen will now display:



```
Device Status
```

Turn the rotary control until the screen displays:



```
Interface Status
```

Press the rotary control and the screen will now display:



```
Fault Status
```

Turn the rotary control until the screen displays:



```
Start Fast Test
```

Press the rotary control and the screen will now display:



```
Test Timeout 1min
```

Turn the rotary control until the screen displays the time-out duration required and press the rotary control. The display will show:



```
Fast Test 00:59
```

Press the BACK button, to return to the front display:



```
DEV02 AL00 FT00
```

Ident – This menu shows the unique identification number for the device.

Software Version – This menu shows the software version currently installed in the device.

Audio Detect - This option allows the No Sndr Audio fault reporting to be selectable between ON and OFF on the interface and the control panel. If ON is selected, the analogue value 1 which is the No Sndr Audio fault description will be displayed on the interface and the control panel, if this fault type occurs on a sounder device. If OFF is selected, the above fault will not be displayed on the loop module or the control panel. The default is set to OFF, as there are no requirements to display this message type.

Batt Smooth - This option allows the Battery Low fault reporting to be selectable so verification of the low battery can be ascertained before the fault Analogue Value 7 Fault type is displayed on the loop module and the control panel. Available smoothing options are selectable between OFF = No smoothing and 1-5 days smoothing in one day steps. If this feature is implemented, the systems performance is not compromised and the 30 day battery low warning is still achieved. The default is set to OFF, so no smoothing is implemented and the fault type is displayed instantly.

Analogue Value 35 Mode - This option allows an analogue value 35 message from a detector, which is a head dirty/ compensation fault to be a selectable option for displaying on the system. The reporting of this status does not compromise the performance of the sensor and or the sensitivity. It is not a requirement for detectors to report contamination events, hence this selectable mode. The default is to OFF, which will not display these status message types.

Serial Data - This option enables serial data to be seen on a terminal programme via the on-board serial port. If enabled, it is important NOT to leave the loop module in this mode.

Radio Channels

This menu allows the two frequency channels currently used by the loop interface to be viewed and also allows the channels used to be selected either manually or automatically. 32 channels are available for use on the system and these are as follows:

Ch1: 868.048 MHz		Ch9: 868.248 MHz		Ch17: 868.749 MHz		Ch25: 868.950 MHz	
Ch2: 868.073 MHz		Ch10: 868.273 MHz		Ch18: 868.774 MHz		Ch26: 868.975 MHz	
Ch3: 868.098 MHz		Ch11: 868.298 MHz		Ch19: 868.800 MHz		Ch27: 869.000 MHz	
Ch4: 868.123 MHz		Ch12: 868.323 MHz		Ch20: 868.825 MHz		Ch28: 869.025 MHz	
Ch5: 868.148 MHz		Ch13: 868.349 MHz		Ch21: 868.850 MHz		Ch29: 869.050 MHz	
Ch6: 868.173 MHz		Ch14: 868.374 MHz		Ch22: 868.875 MHz		Ch30: 869.075 MHz	
Ch7: 868.198 MHz		Ch15: 868.399 MHz		Ch23: 868.900 MHz		Ch31: 869.100 MHz	
Ch8: 868.223 MHz		Ch16: 868.424 MHz		Ch24: 868.925 MHz		Ch32: 869.125 MHz	

Changing Radio Channels

The two 868 MHz radio channels that the loop module uses for communication between itself and the devices must be selected to allow communication to take place. These channels MUST be selected when the loop module does not have any devices logged on to it. If the loop module does have devices logged on to it, the menus for changing the radio channels will not be available. The recommended method for selecting these channels is by using the Auto Scan option. This option will scan all available channels for a selectable time period and at the end of this time automatically select the two most suitable frequencies which have the least background signal on them. The longer duration the Auto Scan is left running the more accurate the results will be. Available time durations are between 1 min and 60 mins.

To auto select the frequencies on the loop module, the following actions are required:

With the loop interface in its normal state the screen will display:

```
DEV00 AL00 FT00
```

Press the rotary control and the screen will now display:

```
Device Status
```

Turn the rotary control until the screen displays:

```
Radio Channels
```

Press the rotary control and the screen will display:

```
Currently Used
```

Turn the rotary control until the screen displays:

```
Auto Select
```

Press the rotary control and the screen will now display:

```
Scan Time 1 Min
```

Turn the rotary control until the required scan time is shown and then press the rotary control. The screen will now display the time remaining:

```
00:59secs-----
```

When the time has elapsed or the scan aborted (by pressing the rotary control) the display will change to show the selected channels:

```
Auto Ch xx Ch xx
```

Press the rotary control and the screen will now display:

```
View Results N ?
```

It is not normally necessary to view the results so press the rotary control and the screen will now display:

```
Auto Select
```

If the results are required to be viewed turn the rotary control until 'View Results Y?' is shown and then press the rotary control. All channels can now be shown.

Press the Back Button to return to the normal front screen display.

```
DEV00 AL00 FT00
```

How To Improve Signal Levels

Device signal levels can be improved by following the flowchart below:

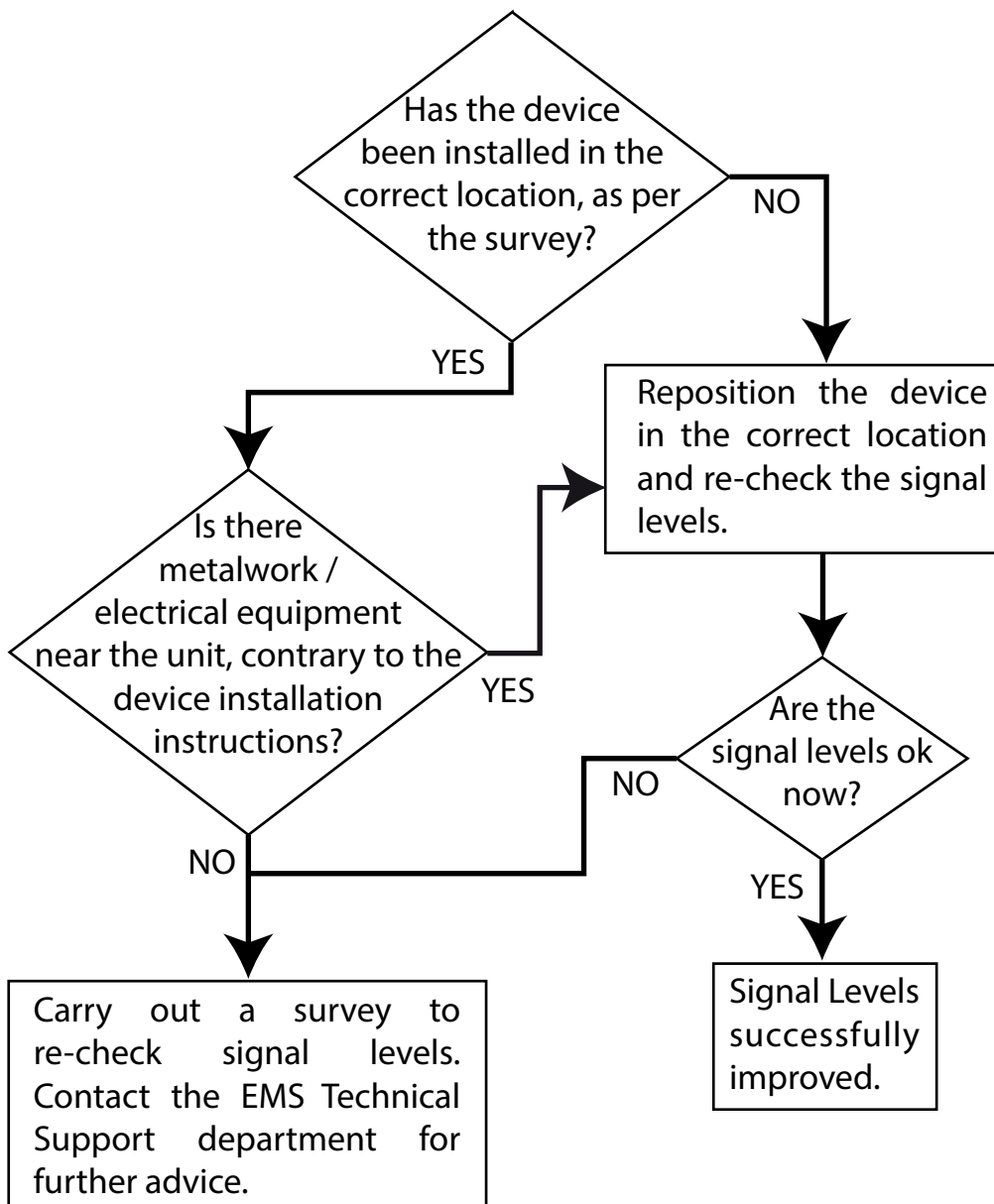

Analogue Value Table

Analogue Value	Device Type	Device Type
0	All	Battery missing from pack 1 or 2
1	Detector	Detector head fault
1	Sounder	No audio output from sounder
2	Detector	Detector head missing
3	Sounder	Sounder head missing
4	All	Device in tamper
4	Input/Output device	Input open or short circuit
4	Loop Interface	Aerial tamper
7	All	Batteries low. Replace all within 30 days
13	All	Radio signal strength caution
14	All	Radio signal strength low
16	Call Point, Sounder & Input Output device	Radio signal strength good or medium
20	Detector	Radio signal strength medium
25	Detector	Radio signal strength good
35	Detector	Detector head dirty
50	Detector	Detector in pre-alarm condition
64	Call Point	Call Point in alarm condition
85	Detector	Detector in alarm condition



 www.emsgroup.co.uk

 +44 (0) 1227 369570

 enquiries@emsgroup.co.uk



Fire Industry Association



The information contained within this literature is correct at time of publishing. EMS reserves the right to change any information regarding products as part of its continual development enhancing new technology and reliability. EMS advises that any product literature issue numbers are checked with its head office prior to any formal specification being written.