

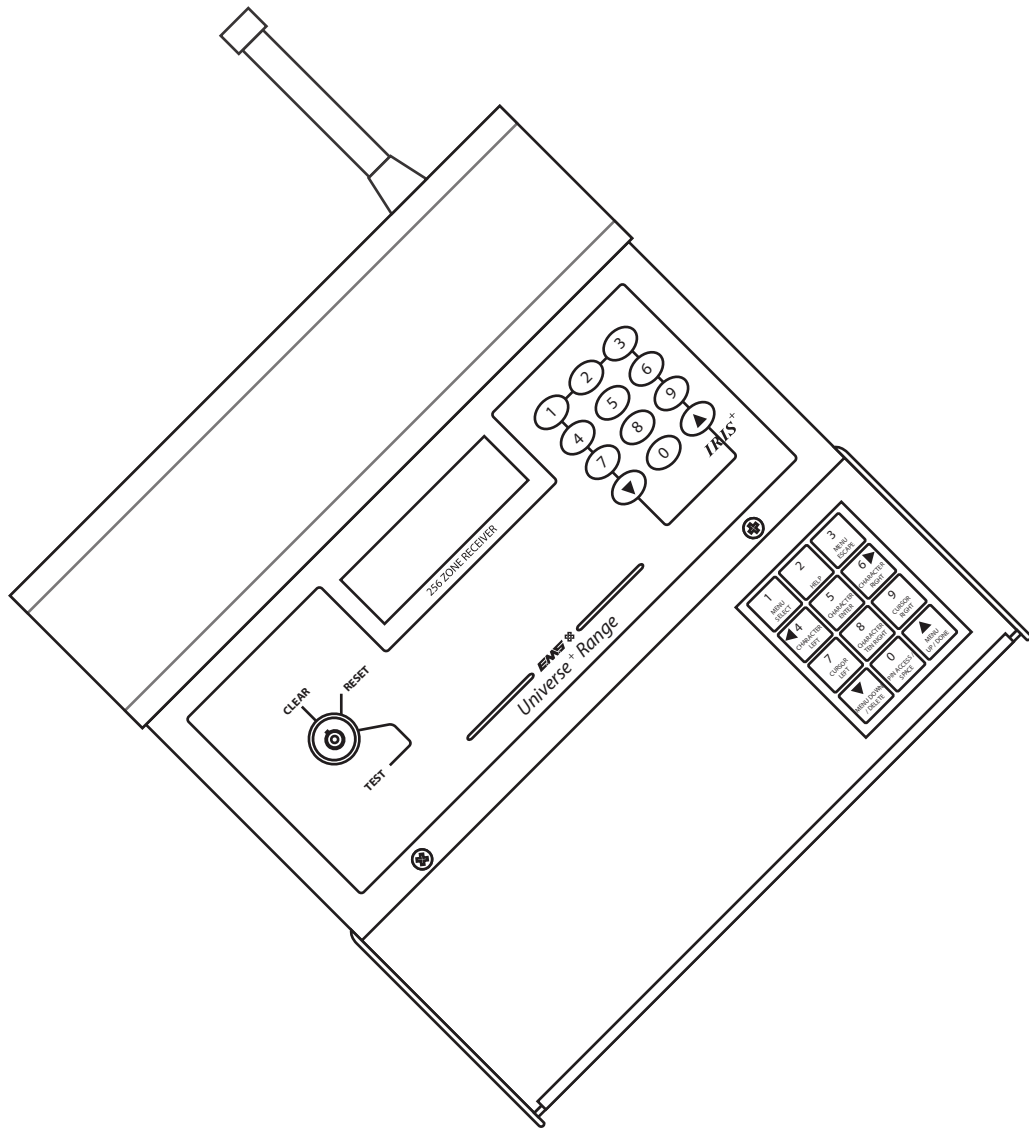

IRIS+

Installation Guide



Contents

Menu structure	4-5
Introduction	6
Tools & test equipment	6
Accessing the engineering menus	7
Receiver and transmitter location	7
Checking background interference levels	8
How to reduce interference	9
Monitoring transmitter signals	9
Installation	10-12
Iris+ back box connections explained	13-14
Post installation testing	15
Operating instructions	16
Adding a transmitter	17
Naming a transmitter	18-19
Deleting a transmitter	20
Add a new user	21-22
Transmitter grouping	23-24
Relay output configuration	25-26
Example relay wiring	27
Helpful hints	28
Glossary	29
Appendix	29
Technical specifications	30

Menu structure (part 1)

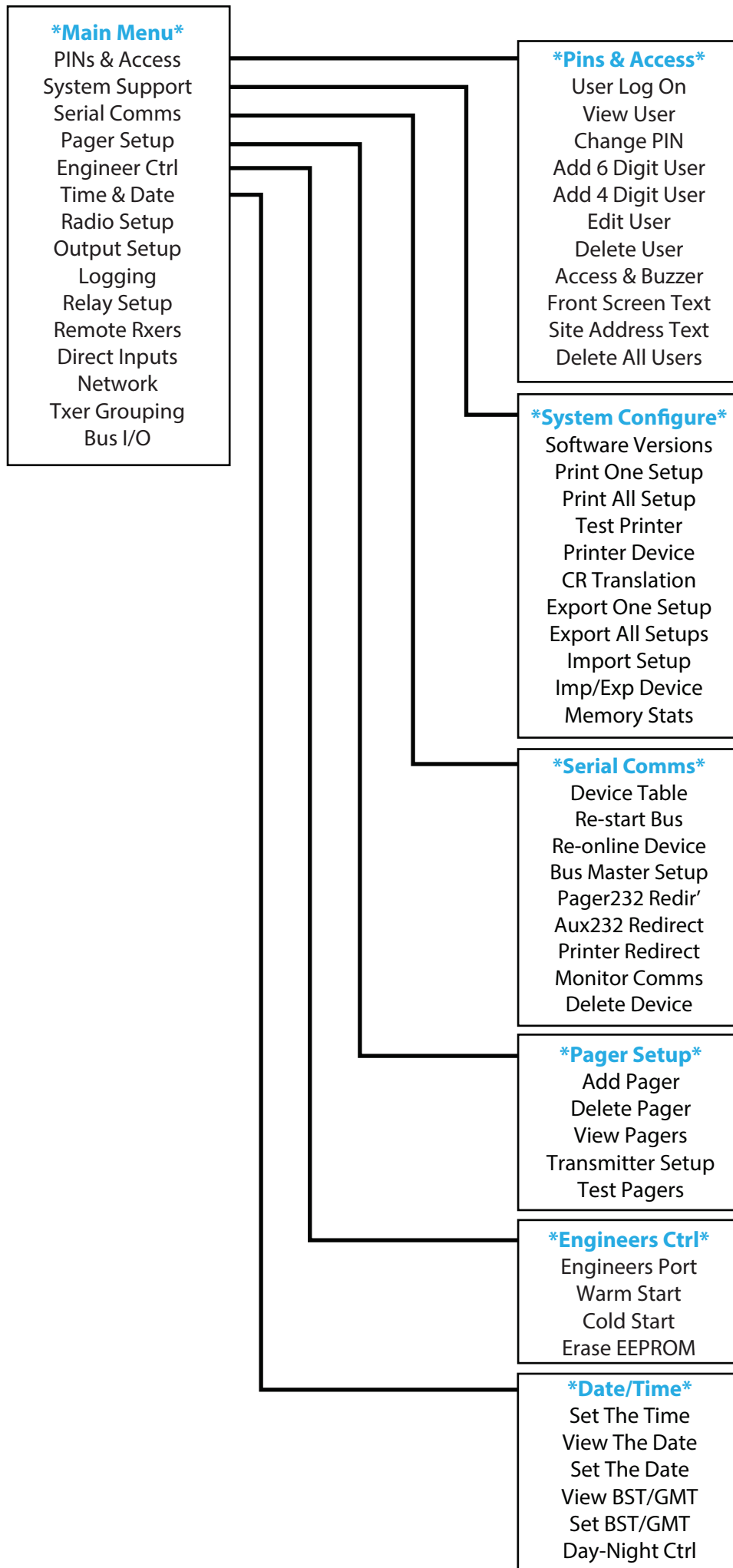

Menu structure (part 2)

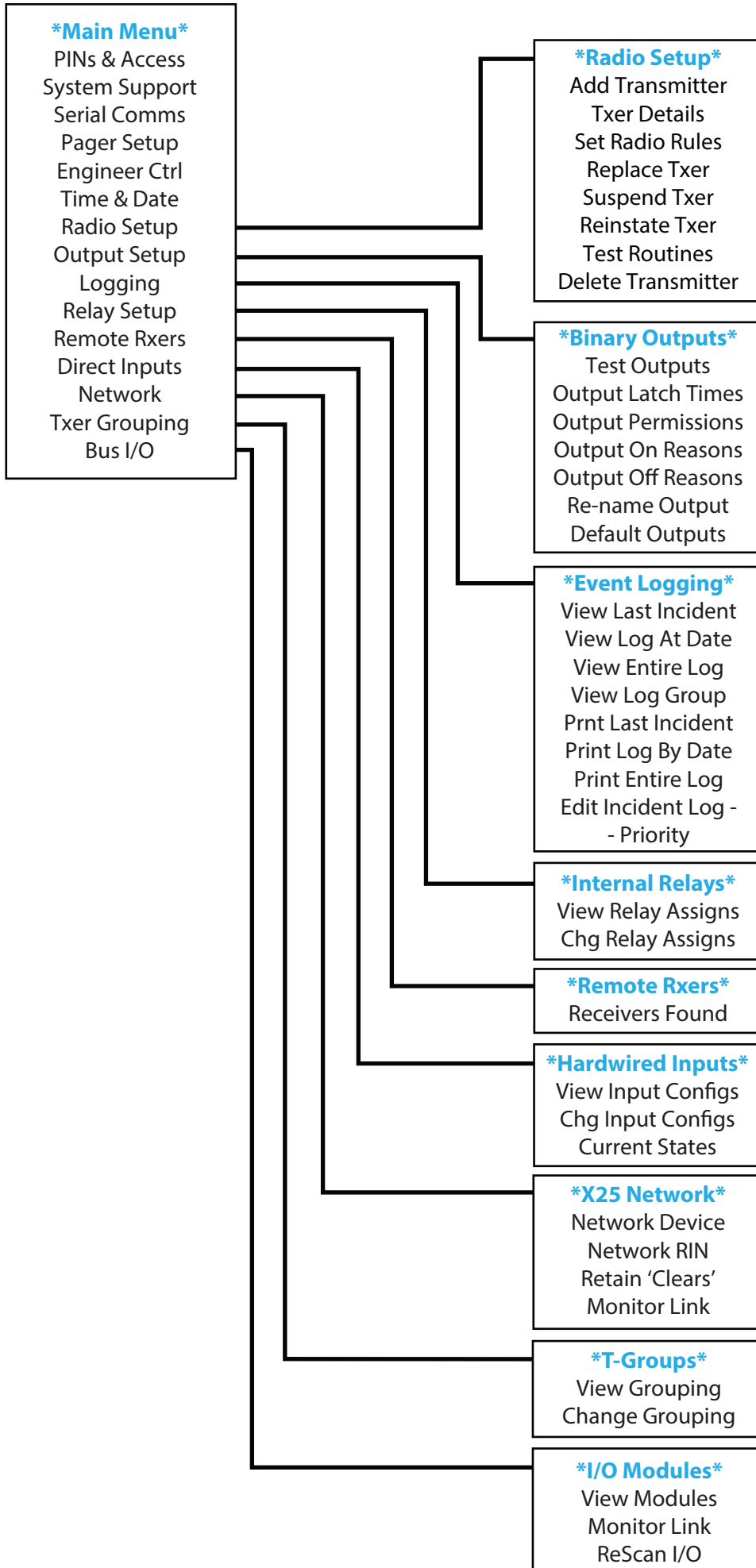

Introduction

The Iris+ is a wireless personal attack system ideal for use in all types of financial, industrial and commercial premises, where staff need the security of a personal attack alarm with total mobility. The use of the latest techniques in design with the extensive use of surface mount technology and microprocessors makes Iris+ a highly reliable, flexible and user friendly system.

With most of the systems features under software control, Iris+ can easily be configured to meet a specific customers requirements. Communication with the user is via a Liquid Crystal Display (LCD), which shows the system status at all times.

Capable of identifying 256 individual transmitters, extensive event and historic logs, Personal Identification Number (PIN) access and antenna tamper are just a few of the features offered by Iris+. The wide range of features and facilities incorporated into Iris+ are normally only found in full alarm control equipment, making Iris+ unique in wireless personal attack systems and a leader in the field.

The Iris+ system consists of a single fixed receiver unit, the required number of transmitter units and ancillary equipment dependant upon application. The Iris+ receiver is installed within a rigid casing and mounted at a predetermined location, while the transmitters can be installed into portable push-button Units, fixed money clip units or fixed contact operated units. In addition the Iris+ will accept up to eight hard wired inputs via an input module.

Note: Regular users of the Iris system will notice that the latest version of Iris+ comes with the added benefits of a refined PCB layout and all software features unlocked as standard. The Iris+ industry renowned ease of operation and functionality remain exactly the same.

Tools & test equipment

No special test equipment is needed when installing the receiver. Only standard hand tools are required to install and commission the system.

Accessing the engineering menus

To access the engineering menus, follow the steps listed below:

- Once powered and the Iris+ has completed system and configuration checks, the LCD screen will display:
- Turn the front panel key to reset. The screen will change to display:
- Press the 0 key, the screen will now change to display:
- Enter the engineering default PIN: *221100* and press  . The screen will change to display:

```
System Clear
08/05/18      13:26
```

```
*** SYSTEM RESET ***
13:26
```

```
Enter Your PIN
For Menus > _
^=Done  v=Del  13:26
```

```
| ** Main Menu ** |
> Pins & Access <
| System Support |
2=Help          13:27
```

Receiver and transmitter location

The maximum range between the Iris+ receiver and any transmitter is dependant upon the environment in which the system is operating. Iris+ has a range of typically 250 metres in open line of sight (dependant on the type of aerial used). The actual range achieved is determined by local site conditions and how well the system has been installed.

When selecting a site for the receiver, the installing engineer should be aware that the aerial has to be as far away from other electrical / electronic equipment as possible and a minimum of 2 metres from any such equipment. Locating the receiver closer than this will effect the systems performance. Metal objects such as filing cabinets, pipe work, radiators and air conditioning ducts will also adversely effect the performance of the system if they are too near the receivers antenna.

Before final installation, carry out site tests to ensure that the system gives the site coverage required at the position chosen.

With the Iris+ receiver as close to its proposed position as possible, fit the antenna to the BNC socket on top of the receiver and connect power to the receiver. On power-up the Iris+ will perform a Warm Start and then display the System Clear message on the Liquid Crystal Display (LCD) screen.

Checking background interference levels

Access the Main Menu by following the operations listed under the previous '[Accessing the engineering menus](#)' section.

The Iris+ should now be set up to Monitor Background Signals as their presence at a high level may effect the performance of the system. To enter this mode from the Main Menu select; **Radio Setup** > **Test Routines** > **Monitor Carrier**.

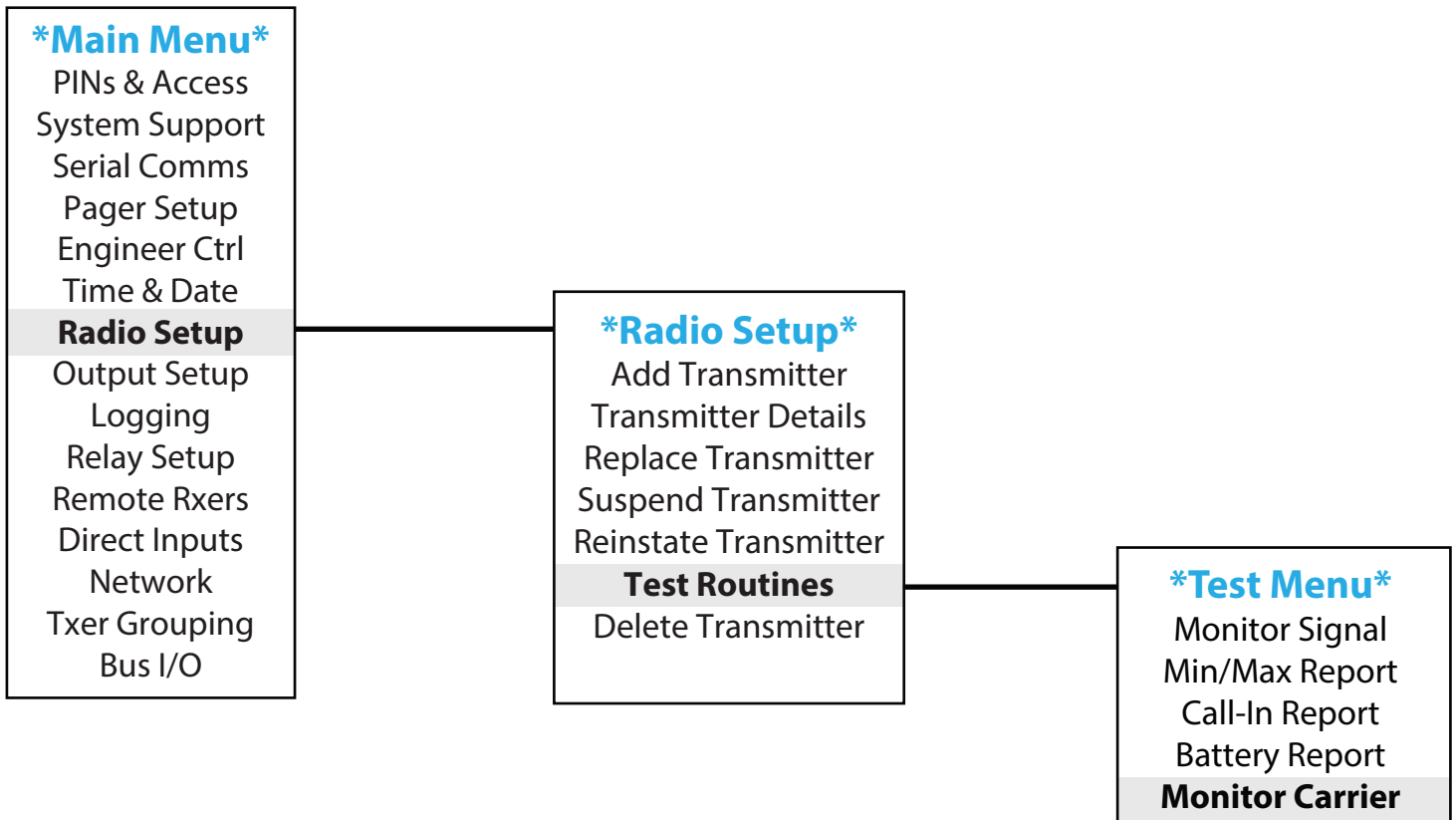

With Iris+ in Monitor Carrier mode the screen will show any background signals on and around the frequency at which Iris operates. A typical screen shot is shown below. NOTE: Background signals are generated by other electronic equipment such as computers, Fax machines, mobile phones, surveillance cameras.

```
Monitoring Carrier  
Level = 26  
Highest = 27  
->-- 13:35
```

An acceptable level of background noise is between 0 and 55. Any higher indication may adversely effect the performance of the system. If the level is shown to be high, there are a number of steps that can be taken to reduce the reading, these are outlined overleaf.

How to reduce interference

- Step 1** Move the receiver away from likely source of interference.
- Step 2** Fit a high gain UHF antenna to the receiver. *EMS Part number 7328.*
- Step 3** Add a Remote Receiver to the system. *EMS Part number 7258.*
- Step 4** Add a Transponder to the system. *EMS Part number 7723.*

Using one or a combination of the above it should be possible to reduce the background carrier signal at the Iris+ receiver to an acceptable level.

Should the above steps fail to suitably reduce interference, contact EMS Technical Support for more information.

Monitoring transmitter signals

With the Iris+ key turned to the test position, tested transmitter's unique identities will be displayed on the screen, along with their signal strength readings. A typical screen shot is shown below.

Handpush 013	TEST
	230
Alarm	
^ to END	13:35

Ensure that all transmitters are tested. The maximum reading obtainable is 255, however in practice this reading is almost never attained. Any reading 30 above the background carrier figure is acceptable, although the higher the signal the better overall performance will be achieved by the system.

For more information on identifying the background carrier, refer to the 'Checking background interference levels' section, on page 8.

Where results are found not to be acceptable, taking the previously outlined 'how to reduce interference' steps, will improve the reception from distant transmitters giving weak signals.

Once testing is complete, turn the Iris+ key to the clear position.

Installation

The Iris+ receiver consists of two sections, firstly the front casing which houses the receiver / processor PCB and secondly the rear casing which houses the external connection PCB. The installation of the Iris+ receiver requires the separation of the two sections and the fixing of the rear back box section to the wall. To complete the installation the front casing is then re-assembled onto the rear back box. The following paragraphs outline the installation in a step by step format;

1 Open lid

Open the lower lid to expose the keypad and LCD display.

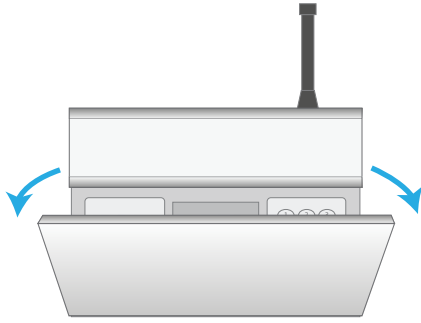

2 Remove retaining screws

Remove the two circled front retaining screws.

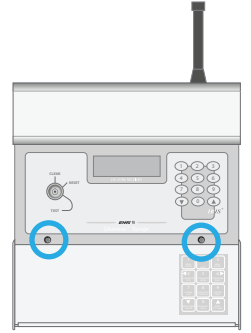

3 Open unit

Open the unit, by lifting the display.

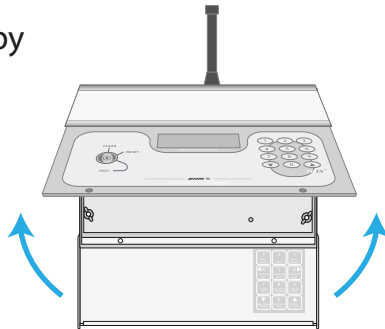

4 Remove wing nuts

Remove the four circled M4 wing nuts.

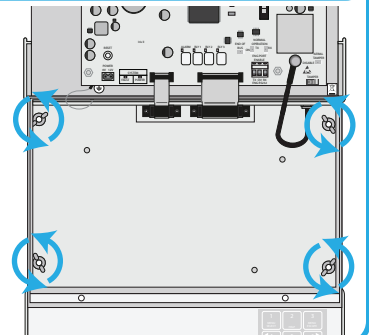

5 Remove front section

The front section of the unit can now be separated from the back box.

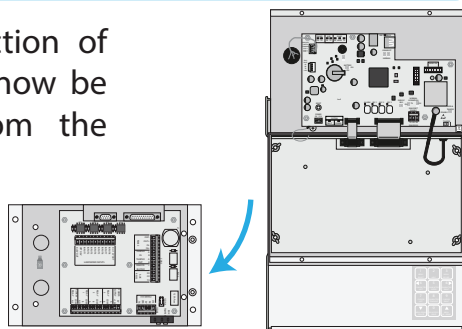

6 Remove cable entry points

Remove the cable entry blanking plates shown, as necessary.

Be careful not to damage the printed circuit board within the unit.

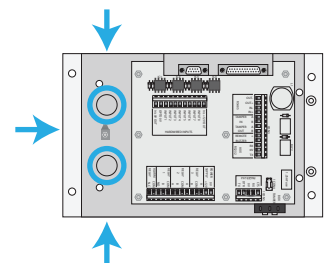

7 Check rear tamper

Offer the back box to the wall.

Ensure that the rear tamper switch operates. If necessary, remove the unit from the wall and carefully adjust the microswitch arm.

8 Fix back box

All four circled positions must be used, to ensure a firm fixing.

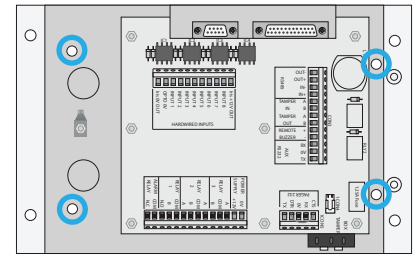

9 Back box connection wiring

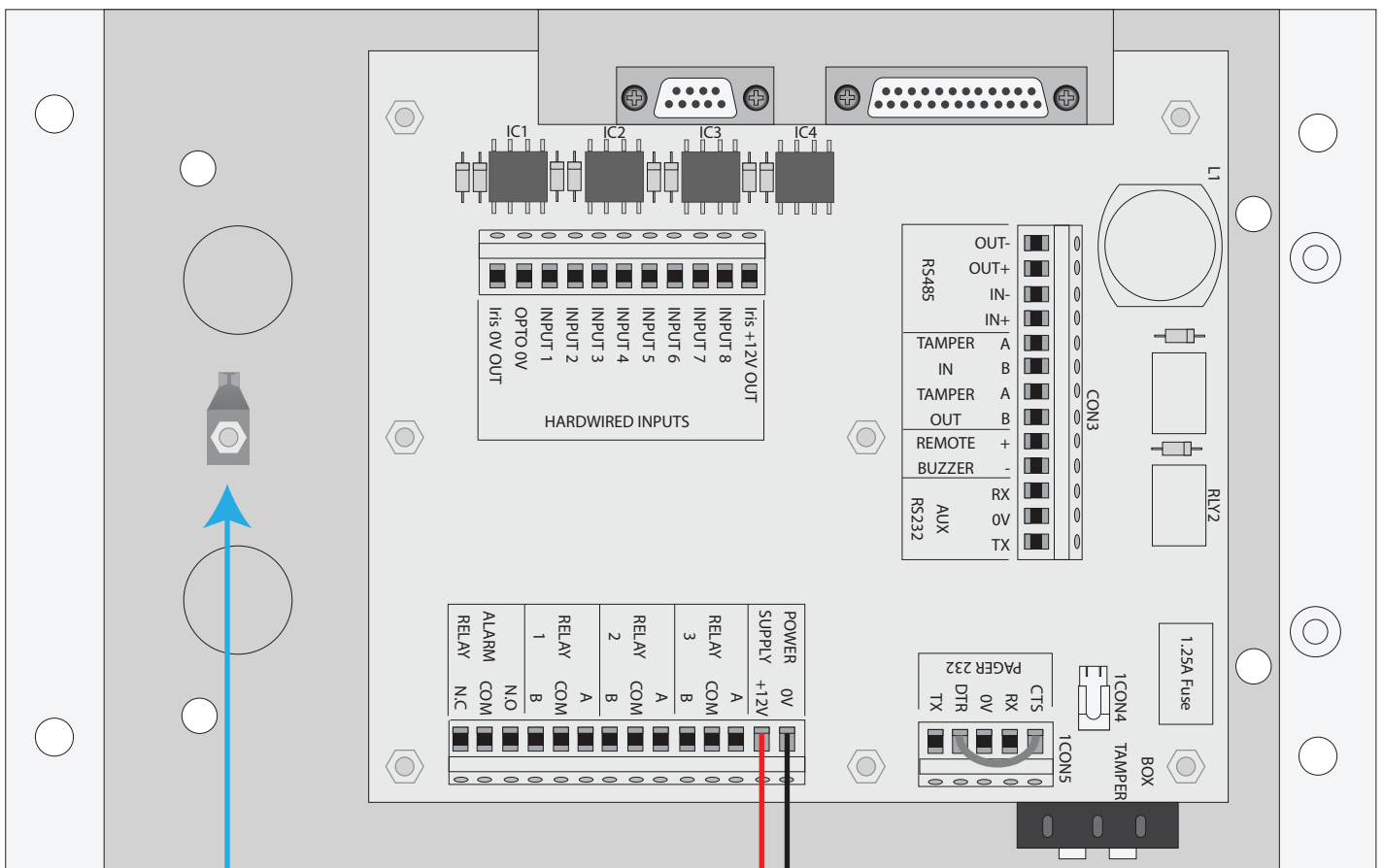

Earth connection

12Vdc power

All external connections should now be made within the back box.

Iris+ must NOT be used as a junction box or cable termination point as this will adversely effect the performance of the system.

The Iris+ case must be earthed. A separate earthing tag is provided and is shown above.

The Iris+ requires a 12Vdc supply. The 0v line must NOT be connected to the same point as the case earth.

Note: details of other back box connections, can be seen on pages 13 & 14.

10 Re-attach front section

Re-attach the front section on to the back box, ensuring a firm connection.

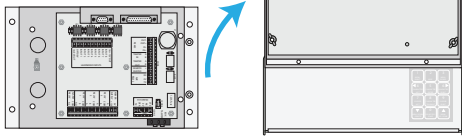

11 Replace wing nuts

Replace all four M4 wing nuts, and fully tighten to ensure a secure connection.

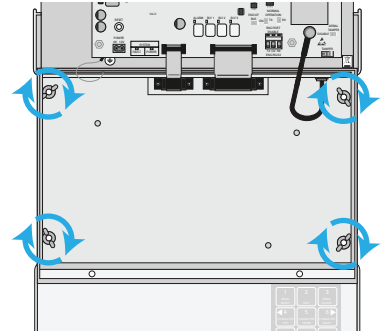

12 Close display

Close the display.

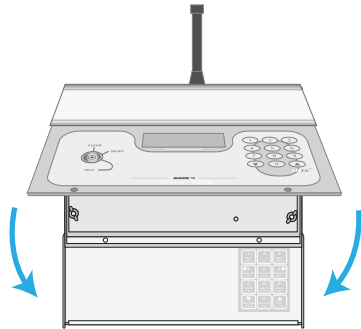

13 Replace retaining screws

Replace the two circled front retaining screws.

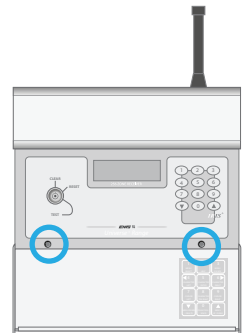

14 Apply power

Power can now be applied.

After approx. 5 seconds, the LCD screen should display 'System Clear' as shown.

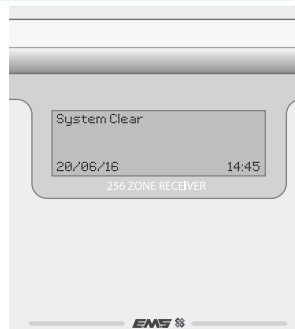

15 Installation complete

The installation is now complete.

The system should now be fully tested. See page 15.



Iris+ back box connections explained

9 way D connector	Used for connection to the Iris+ front box.
25 way D connector	Used for connection to the Iris+ front box.
RS485 (<i>OUT -</i> , <i>OUT +</i> , <i>IN -</i> & <i>IN +</i>)	RS485 Bus used for remote receiver/output module connection with the Iris+ receiver. <i>OUT -</i> and <i>OUT +</i> are taken to the remote receivers/output modules <i>IN -</i> and <i>IN +</i> respectively.
TAMPER (<i>IN A</i> , <i>IN B</i> , <i>OUT A</i> & <i>OUT B</i>)	A Link is factory fitted between Tamper <i>IN A</i> and <i>IN B</i> terminals. This allows operation of the front tamper switch but disables the rear tamper switch. If the rear tamper switch is also required two links should be made, these are between Tamper <i>In A</i> to Tamper <i>Out A</i> and Tamper <i>In B</i> to Tamper <i>Out B</i> .
REMOTE BUZZER (+ & -)	The remote buzzer output allows up to a 500mA buzzer to be connected to the receiver, which will follow the operation of the units internal buzzer.
Aux 232 (<i>RX</i> , <i>0V</i> & <i>TX</i>)	The Aux 232 is a serial RS232 port which can be used for importing and exporting system information between the Iris+ and a terminal programme.
Rear Tamper	This is a two way connector pre-wired from the units rear tamper switch.
Pager 232 (<i>CTS</i> , <i>RX</i> , <i>0V</i> , <i>DTR</i> & <i>TX</i>)	The Pager 232 connector is a RS232 port which is used for connection to an EMS text pager transmitter . The port is also used to receive information from EMS alarm control equipment and also pass this to the pager transmitter.
Power supply (<i>0V</i> & <i>12V</i>)	0Vdc and 12Vdc input to the Iris+ unit. Current draw is 80mA standard at 12Vdc supply and 250mA at 12Vdc with the Back lit display activated.
Relay 3 (<i>A</i> , <i>COM</i> & <i>B</i>)	Programmable non energised 1 Amp relay output.
Relay 2 (<i>A</i> , <i>COM</i> & <i>B</i>)	Programmable non energised 1 Amp relay output.
Relay 1 (<i>A</i> , <i>COM</i> & <i>B</i>)	Programmable non energised 1 Amp relay output.
Alarm Relay (<i>NO</i> , <i>COM</i> , <i>NC</i>)	Programmable energised 1 Amp relay output.

Iris 12V OUT	12Vdc output which can be used if required, to trigger inputs 1-8.
INPUT 8	Hardwired Input 8 programmable for N/O or N/C operation. 5-12Vdc applied or removed to trigger dependant on programming.
INPUT 7	Hardwired Input 7 programmable for N/O or N/C operation. 5-12Vdc applied or removed to trigger dependant on programming.
INPUT 6	Hardwired Input 6 programmable for N/O or N/C operation. 5-12Vdc applied or removed to trigger dependant on programming.
INPUT 5	Hardwired Input 5 programmable for N/O or N/C operation. 5-12Vdc applied or removed to trigger dependant on programming.
INPUT 4	Hardwired Input 4 programmable for N/O or N/C operation. 5-12Vdc applied or removed to trigger dependant on programming.
INPUT 3	Hardwired Input 3 programmable for N/O or N/C operation. 5-12Vdc applied or removed to trigger dependant on programming.
INPUT 2	Hardwired Input 2 programmable for N/O or N/C operation. 5-12Vdc applied or removed to trigger dependant on programming.
INPUT 1	Hardwired Input 1 programmable for N/O or N/C operation. 5-12Vdc applied or removed to trigger dependant on programming.
OPTO 0V	Requires 0Vdc to be applied to enable a positive voltage to trigger inputs 1-8.
Iris 0V OUT	0Vdc output which is normally linked to the OPTO 0V connection to enable a positive voltage to trigger inputs 1-8.

Post installation testing

Having installed the Iris+ receiver and transmitters, re-test all transmitters from their fixed positions.

With the Iris+ key turned to the test position, tested transmitter's unique identities will be displayed on the screen, along with their signal strength readings. A typical screen shot is shown below.

Handpush 013	TEST
	230
Alarm ^ to END	13:35

Ensure that all transmitters are tested. The maximum reading obtainable is 255, however in practice this reading is almost never attained. Any reading 30 above the background carrier figure is acceptable, although the higher the signal the better overall performance will be achieved by the system.

For more information on identifying the background carrier, refer to the 'Checking background interference levels' section, on page 8.

Where results are found not to be acceptable, taking the previously outlined 'how to reduce interference' steps, will improve the reception from distant transmitters giving weak signals.



Once testing is complete, turn the Iris+ key to the clear position.

Operating instructions

Keyswitch

TEST position; all transmitters or hard wired inputs programmed to the system are able to be tested. A full alarm / local transmission or hard wired input activation will be acknowledged on the LCD screen and the buzzer will sound for approximately 1 second. With the unit set to the factory preset, whilst in this key position none of the relays should be observed to change state upon receipt of a valid transmission or hard wired input activation.

RESET position; all outstanding events will be cleared. Access to the system menus can be gained by pressing the 0 (zero) key and entering a valid user PIN number. With the unit set to the factory presets, whilst in this key position none of the relays should be observed to change state upon receipt of a valid transmission or hard wired input activation.

CLEAR position; any alarm transmission(s) will be acknowledged on the LCD screen and the alarm relay will latch until cleared by moving the keyswitch to reset. A local transmission will be acknowledged on the screen (providing an alarm transmission has not been received), the local relay will change state for a period of approximately 4 seconds and the buzzer will then sound until the keyswitch is moved to the reset position. Use of the  or  buttons allows the user to step through the events in the incident log.

Display

The 80 character LCD display shows the current state of the system, or displays any activations not yet cleared to the event log. Information is also provided on the bottom line about the current time and date. A single alpha numeric digit, preceding the time, displays information about the receipt of transmissions or warnings of RFI (radio frequency interference) and power supply failure.

Adding a transmitter

To add any additional transmitters, access the Main Menu by following the operations listed under the previous '[Accessing the engineering menus](#)' section.

Now, follow the steps listed below:

- Press the  button four times, the screen will now display:



```
| Time and Date |  
> Radio Setup <  
| Output Setup |  
2 = Help 13: 47
```

- Press the  button. The screen will change to display:



```
| ** Radio Setup ** |  
> Add Transmitter <  
| Txer Details |  
2 = Help 13: 47
```

- Press the  button. The screen will change to display:
(See Appendix 1 for details of transmitter options)

```
| Add Transmitter |  
> Add Handpush <  
| Add Moneyclip |  
2 = Help 13: 47
```

- Use the  or  arrow keys to highlight the type of transmitter to be added and press the  button, the screen will change to display the options available (handpush screen shown):

```
| Handpush Type |  
> Opposed Action <  
| Non-Opposed |  
2 = Help 13: 47
```

- Press the  or  arrows to highlight the transmitter action required and press the  button. The screen will change to display (handpush screen shown):

```
Operate Transmitter  
NOW or press  
Escape to cancel  
13: 48
```

- Operate the unit to generate a transmission and the screen will display:

```
Release all buttons  
NOW  
13: 48
```

- After a short period of time the screen will change to display (handpush screen shown):

```
Operate Transmitter  
Again or press  
Escape to cancel  
13: 48
```

- Using the same operation, once again generate a transmission, after a short period of time the screen will change to display (handpush screen shown):

```
Hand Push 001  
Added  
Push any key  
13: 48
```

You may now add additional transmitters, by repeating the above steps. If no further transmitters are to be added, then escape from this menu by pressing the  button or returning the key to CLEAR.

Naming a transmitter

To change the name of any transmitters, access the Main Menu by following the operations listed under the previous '[Accessing the engineering menus](#)' section.

Now, follow the steps listed below:

- Press the  button four times. The screen will now display:

```
|   Time and Date   |
| >   Radio Setup   < |
|   Output Setup   |
| 2 = Help         13:49 |
```

- Press the  button. The screen will change to display:

```
|   ** Radio Setup ** |
| >   Add Transmitter < |
|   Txer Details     |
| 2 = Help         13:49 |
```

- Press the  button. The screen will change to display:

```
|   Add Transmitter   |
| >   Txer Details   < |
|   Set Radio Rules  |
| 2 = Help         13:49 |
```

- Press the  button. The screen will change to display:

```
|   - Txer Details - |
| >   Name by Number < |
|   Name by Tx      |
| 2=Help           13:49 |
```

- Press the  button once. The screen will display:

```
|   Name by Number   |
| >   Name by Tx    < |
|   View Names      |
| 2=Help           13:49 |
```

- Press the  button. The screen will display:

```
Operate Transmitter
NOW or press
Escape to cancel
13:50
```

- Generate a transmission and the screen will change to display:

```
Release all buttons
NOW
13:50
```

- After a short period of time the screen will display:

```
Operate Transmitter
Again or press
Escape to cancel
13:50
```

- Once again generate a transmission, the screen will change to display:

```
|   |   |   |   |   |   |
| 4< IJKL M NOPQR >6 |
| 2=Help |         13:50 |
```

Note: the current selected character is shown above the centre bar.

By using the (4) button to move left or the (6) button to move right, move to the letter or number required. Press (5) button to select the character.

Repeat until all letters have been selected. Once completed press the (▲) button to save the information.

Repeat the previous steps, for any other transmitters requiring naming.

Once complete, you may now escape from this menu by pressing the (3) button until the SYSTEM RESET message appears or by returning the key to the CLEAR position.

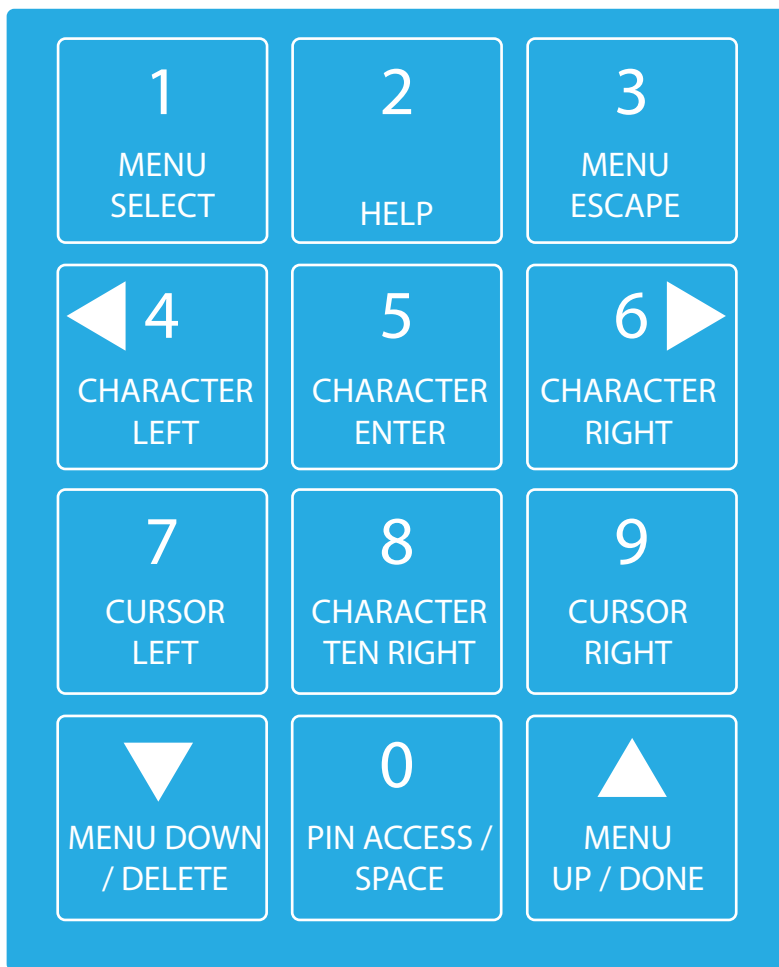

Deleting a transmitter

To delete a transmitter, access the Main Menu by following the operations listed under the previous '[Accessing the engineering menus](#)' section.

Now, follow the steps listed below:

- Press the  button four times. The screen will now display:

```
| Time and Date |
| > Radio Setup < |
| Output Setup |
| 2 = Help 13:51 |
```

- Press the  button. The screen will change to display:

```
| ** Radio Setup ** |
| > Add Transmitter < |
| Txer Details |
| 2 = Help 13:51 |
```

- Press the  button seven times. The screen will change to display:

```
| Reinstater Transmitter |
| Test Routines |
| > Delete Transmitter < |
| 2 = Help 13:51 |
```

- Press the  button. The screen will change to display:

```
| > Delete Transmitter < |
| Delete by Number |
| Delete by Tx |
| 2=Help 13:51 |
```

- Press the  button once. The screen will change to display:

```
| Delete Transmitter |
| > Delete by Number < |
| Delete by Tx |
| 2=Help 13:51 |
```

- Press the  button. The screen will change to display:

```
Enter Transmitter
Number: _
^ = Done v = Del 13:52
```

- Enter the transmitter number to be deleted and the screen will change to (*screen shown for Handpush 001*):

```
Hand Push 001
Delete ?
1=Yes 0=No 13:52
```

- Press 1 (one) to accept and the screen will change to:
Press any key and you will return to the delete transmitter menu.

```
Hand Push 001
Deleted
Press Any Key 13:52
```

Repeat the above steps for any further transmitters to be deleted, or press the  button three times to escape to the main menu.

Add a new user

To gain access to Iris+ a valid PIN number must be entered from the keypad. Each PIN programmed into the system will have a security level associated with it, this is known as the access level and will determine which features are available to the holder of a particular PIN. The chart below gives details on 2 of the 6 access levels available, for further details of the access levels consult the 'Engineers Programming Manual'.

Access level	Level name	Purpose	PIN number
11 - 50	General user	Restricted menu options	4 or 6 digit
51 - 80	Reset user	Restricted menu options	4 or 6 digit

Now, follow the steps listed below:

Access the Main Menu by following the operations listed under the previous '[Accessing the engineering menus](#)' section.

- Press the **1** button. The screen will change to display:
- *Decide which type of user you are to add and whether they will use a 4 or 6 digit PIN.*
- Press the **▼** button until the screen displays **Add 6 Digit User** or **Add 4 Digit User** (as chosen in the previous step):
- The screen will now show:
- Press any key and the screen will change to display:
The current selected character is shown above the centre bar.
- By using the **4** button to move left or the **6** button to move right, move to the letter or number required. Press the **5** button to select the character.
- When you have completed the selections press **▲** the button.
- The screen will now change to display:
Enter the user's access level and press the **▲** button to accept the selection.
- The screen will now change to display:

```

| ** Pins & Access ** |
>   User Log On   <
|   View Users   |
2=Help           13:55
  
```

```

|   Change PIN   |
> Add 6 Digit User <
| Add 4 Digit User |
2=Help           13:55
  
```

```

Enter the New
Users Name

Push Any Key     13:55
  
```

```

|               |
|               |
4< HIJKL M NOPQRS >6
2=Help         13:55
  
```

```

| KAREN        |
|               |
4< IJKL M NOPQRST >6
2=Help         13:55
  
```

```

Enter User 02's
Security Level
(2-99):_
^=Done  v=Del  13:55
  
```

```



|   Change PIN   |
> Add 6 Digit User <
| Add 4 Digit User |
2=Help           13:55
  
```

■ Press the  button once and the screen will display:

```
|      View Users      |  
>      Change Pin      <  
|      Add 6 Digit User  |  
2=Help                      13:55
```

■ Press the  button once and the screen will display:

```
| * Change PIN for ? * |  
> 00/ Engineer, 01    <  
| 02/ Karen, 10      |  
2=Help                      13:56
```

■ Use the  key to highlight the user entered and press the  button once. The screen will now change to display:

```
Enter Karen's  
New 6 Digit  
PIN No.: _  
^ =Done  v =Del  13:56
```

■ Enter the chosen PIN number and press the  button. The screen will change to:

```
Confirm Karen's  
New 6 Digit  
PIN No.: _  
^ =Done  v =Del  13:56
```

■ Once again enter the chosen PIN number and press the  button. The screen will change to display:
Pressing any key will return you to the pins and access menu.

```
Changed PIN for  
User 02 'Karen'  
** Press Any Key ***  
13:56
```

NOTE: If the re-entered pin is incorrect or is one of the 25% automatically rejected for security reasons, re-enter the PIN number.

Transmitter grouping

Each of the transmitters programmed into Iris can be allocated to a transmitter group. These groups can then be assigned to make one or more relays operate. This will allow a wide variety of options to be set up where designated transmitters will operate specific relays.

The Menu structure for the Grouping Task is shown below.

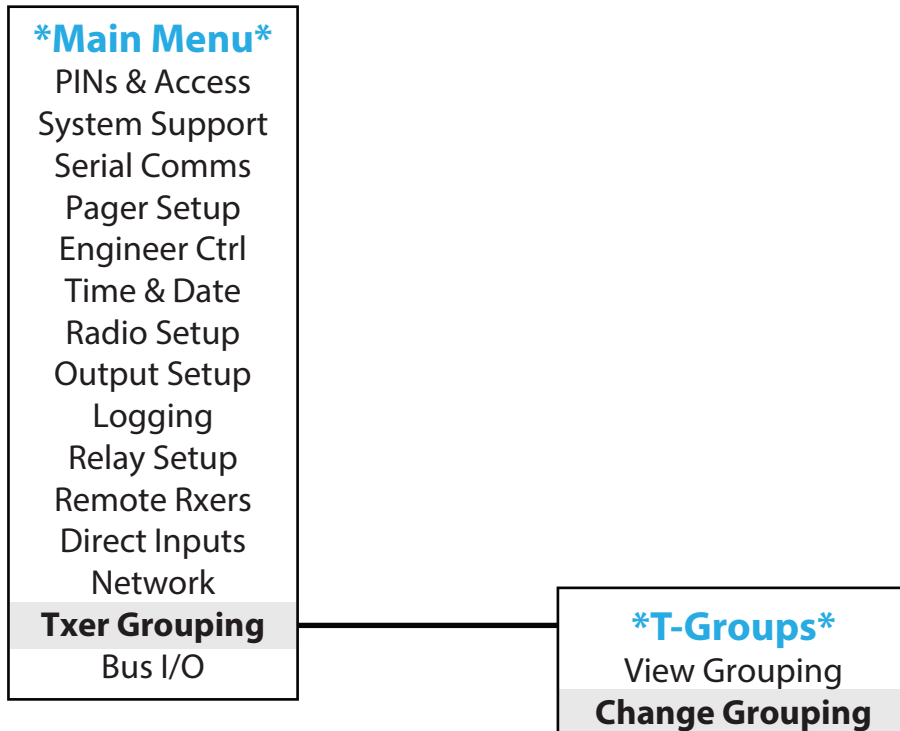

Change Grouping: Selecting this option allows the various groups to be altered. There are a maximum of 16 groups available. Each group can have its event configured. The event can be best described as the way the group will respond to a signal. The valid options are shown below:

Event options	Group response
Alarm	An Alarm signal from any transmitter in the group.
Local	A Local signal from any transmitter in the group.
P-Call	A P-Call alarm signal from any personnel call transmitter in the group.
X-Alarm	Any Local or P-Call signal but NOT an Alarm signal from any transmitter in the group.
X-Local	Any Alarm or P-Call signal but NOT a Local signal from any transmitter in the group.
Any	Any signal from any transmitter in the group.
None	No operation

Example transmitter grouping

The following example shows how to assign an alarm transmission from handpush 001, to transmitter group 1 (Tgroup1). Follow the steps below:

Access the Main Menu by following the operations listed under the previous 'Accessing the engineering menus' section.

- Press the  button until the screen displays:

```

|      Network      |
| > Txer Grouping < |
|      Bus I/O     |
| 2=Help           14:00 |
  
```

- Press the  button. The screen will change to display:

```

|      ** T - Groups ** |
| > View Grouping < |
| Change Grouping |
| 2=Help           14:00 |
  
```

- Press the  button until the screen displays:

```

|      View Grouping |
| > Change Grouping < |
| ^^^^^^^^^^^^^^^^^ |
| 2=Help           14:00 |
  
```

- Press the  button until the required group is displayed:
In this example, Tgroup No:1

```

|      ** T - Groups ** |
| > Tgroup No: 1 < |
| Event : None |
| 2=Help           14:00 |
  
```

- Press the  button once and the screen will display:

```

|      TGroup No: 1 |
| > Event: None < |
| No of Items: 0 |
| 2=Help           14:00 |
  
```

- Press the  button until the required action is displayed:
In this example Event: Alarm



```

|      TGroup No: 1 |
| > Event: Alarm < |
| No of Items: 0 |
| 2=Help           14:00 |
  
```

- Press the  button once and the screen will display:

```

|      Event: Alarm |
| > No of Items: 0 < |
| ^^^^^^^^^^^^^^^^^ |
| 2=Help           14:01 |
  
```

- Press the  button. The screen will change to show a list of the transmitters programmed into the system:
If required, press  &  until the required device is selected.

```

|      ** Select Item ** |
| > Hand Push 001 < |
| ----- |
| 2=Help           14:01 |
  
```

- Press the  button to select the required transmitter. The screen will change to display:

```

|      Saving Data |
|      Please Wait |
| 2=Help           14:01 |
  
```

- Followed by:

```

|      Event: Alarm |
| > No of Items: 1 < |
| ^^^^^^^^^^^^^^^^^ |
| 2=Help           14:01 |
  
```

- Press the 3 key twice to return to the Main Menu.

Note: transmitter groups must now be allocated to relay outputs. See overleaf.

Relay output configuration

Available events that can be used to make the Iris+ relay outputs operate are as follows:

NOTHING	No action to be taken
GROUP: HUA ALARM*	Raid alarm transmissions
GROUP: HUA LOCAL*	Raid local alert transmissions
GROUP: DISPLAY*	Events to be displayed, not logged
GROUP: FAULT*	Equipment failiure/malfunctions
GROUP: LOG *	Events to be logged when in clear
GROUP: TAMPER*	Tamper events
GROUP: RECORD*	Events to be recorded (logged) at all times
GROUP: ALARM*	General alarms transmissions
GROUP: LOCAL*	General local transmissions
GROUP: NETWORK*	Events sent over a network link
EVENT: IRIS TO CLEAR	Events considered to be clear transmissions
EVENT: IRIS TO RESET	Iris control keyswitch in the 'reset' position
EVENT: ARMING THE SYSTEM	Iris control keyswitch in the 'clear' position
EVENT: IRIS TO TEST	Iris control keyswitch in the 'test' position
EVENT: TXER GROUP 1 ON	Transmitter group 1 is active (<i>as used in the previous section</i>)
EVENT: TXER GROUP 2 ON	Transmitter group 2 is active
EVENT: TXER GROUP 3 ON	Transmitter group 3 is active
EVENT: TXER GROUP 4 ON	Transmitter group 4 is active
EVENT: TXER GROUP 5 ON	Transmitter group 5 is active
EVENT: TXER GROUP 6 ON	Transmitter group 6 is active
EVENT: TXER GROUP 7 ON	Transmitter group 7 is active
EVENT: TXER GROUP 8 ON	Transmitter group 8 is active
EVENT: TXER GROUP 9 ON	Transmitter group 9 is active
EVENT: TXER GROUP 10 ON	Transmitter group 10 is active
EVENT: TXER GROUP 11 ON	Transmitter group 11 is active
EVENT: TXER GROUP 12 ON	Transmitter group 12 is active
EVENT: TXER GROUP 13 ON	Transmitter group 13 is active
EVENT: TXER GROUP 14 ON	Transmitter group 14 is active
EVENT: TXER GROUP 15 ON	Transmitter group 15 is active
EVENT: TXER GROUP 16 ON	Transmitter group 16 is active
EVENT: ALARM	Alarm from an alarm transmitter
EVENT: MEDITILT ALARM	Alarm transmitter has been in man down position for 45 seconds
EVENT: CONTACT ALARM	Alarm transmission from a contact operated transmitter
EVENT: CALL IN FAIL	Transmitter has failed to call in to the Iris system
EVENT: ALARM STAGE 1 ON	An active stage 1 alarm condition
EVENT: ALARM STAGE 1 OFF	Stage 1 alarm conditon has cleared
EVENT: ALARM STAGE 2 ON	An active stage 2 alarm condition
EVENT: ALARM STAGE 2 OFF	Stage 2 alarm conditon has cleared
EVENT: PERSONNEL CALL	Alarm transmission from a personnel call transmitter

*** Note: Multiple 'GROUP:' type events can be assigned to a relay output**

The following example shows how to configure Output 4 (Relay 3) to change state upon an alarm transmission. This example could be used to operate a Piezo Sounder. Follow the steps listed below:

Access the Main Menu by following the operations listed under the previous '[Accessing the engineering menus](#)' section.

- Press the  button until the screen displays:

```
| Radio Setup |
> Output Setup <
| Logging |
2=Help 14:05
```

- Press the  button. The screen will change to display:

```
| ** Binary Outputs ** |
> Test Outputs <
| Output Latch Times |
2=Help 14:05
```

- Press the  button until the screen displays:

```
| Output Permissions |
> Output On Reasons <
| Output Off Reasons |
2=Help 14:05
```

- Press the  button. The screen will change to display:

```
Output On Reasons
1 = Change On Reason
3 = Exit / Finish
2=Help 14:05
```

- Press the  button. The screen will change to display:

```
| * Output on Reason * |
> 1 / 'Un-named' is <
| Switched on by |
2=Help 14:05
```

- Press the  button until the screen displays the required output to configure: *In this example, Output 4.*

Note: An alternative event type can be selected from pg25.

```
|-----|
> 4 / 'Un-named' is <
| Switched on by |
2=Help 14:05
```

- Press the  button. The screen will change to display:

```
Edit on Reason
for Output 4
1 = deselect reason
2=Help 14:05
```

- Press the  button once and the screen will display:

```
| * Select on Reason * |
> NOTHING <
|-----|
2=Help 14:05
```

- Press the  button until the screen displays the required action:

In this example, Group: 'Alarm'

```
|-----|
> Group: 'Alarm' <
|-----|
2=Help 14:06
```

- Press the  button. The screen will change to display:

```
|-----|
> *REASON*SELECTED* <
| Group: 'Alarm' |
2=Help 14:06
```

- Press the 3 key until SYSTEM RESET is displayed and turn the keyswitch to the Clear position to exit the menu.

Example relay wiring

The example below shows the wiring of the Piezo Sounder into Relay 3, to match the previously detailed **Relay output configuration** section:

Iris+ back box

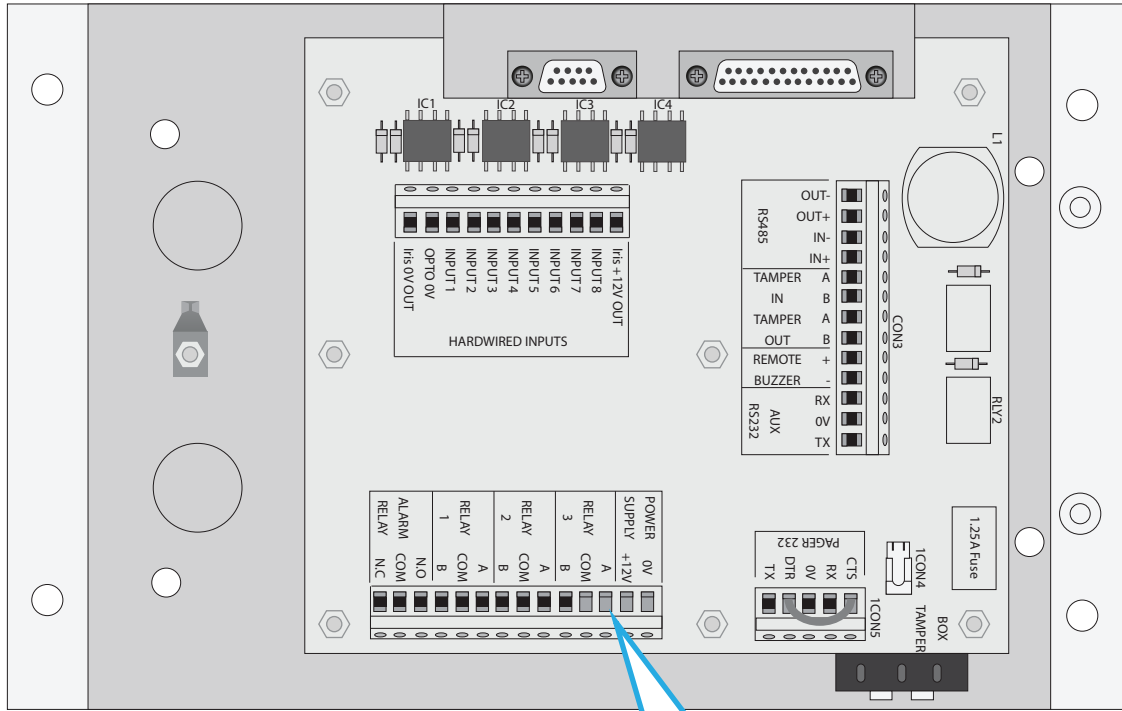

Important note: This is an example only. Any of the four relay outputs could be configured to drive the Piezo Sounder. The relays can also be used for many other applications.

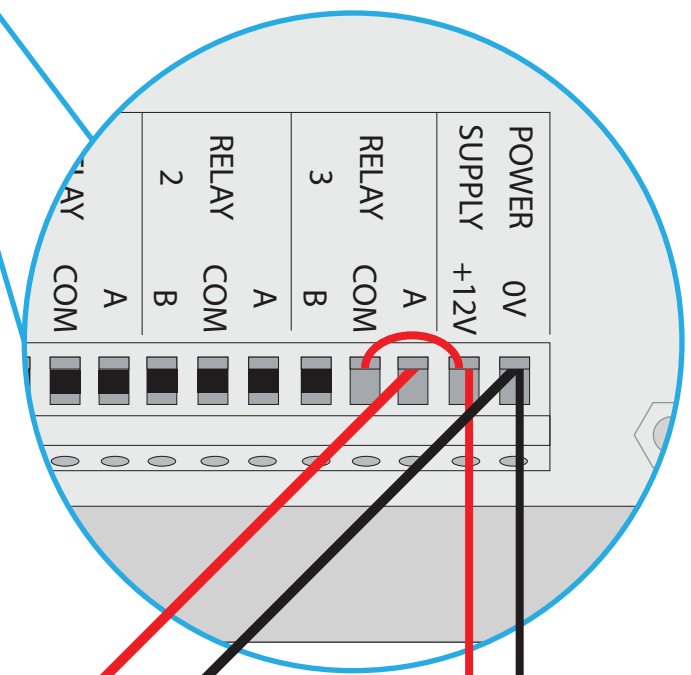

12Vdc Piezo Sounder

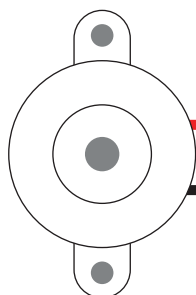

BUZ+

BUZ-

12Vdc power input

Helpful hints

Problem	Possible cause	Action
No indications on the LCD display, no buzzer sounding.	No power to the system	Check power supply and fuses. Re-power unit
'P' displayed preceding time on LCD display	Power below threshold of 10.2Vdc, +/- 0.3Vdc.	Check power supply voltage
'Main Receiver, Aerial Tampered' shown on display and buzzer sounding	Aerial has been removed or tampered with	Check aerial is correctly fitted or replace aerial
'Aerial Tampered, Call Engineer, Antifalse' shown on display and buzzer sounding	Aerial not fitted correctly or tampered with	Check aerial is correctly fitted or replace aerial
'I' displayed preceding time on display	Local radio frequency interference	Refer to the How to reduce interference section
Persistent R.F.I.	Local radio frequency interference	Refer to the How to reduce interference section
'Case Tampered' shown on display	Case is tampered front or back.	Check operation of front and back tamper switches
Keyswitch does not operate	Connector lead not fitted correctly	Check connector lead is fitted correctly
'Call In Fail' shown on display, with transmitter ID	Transmitter out of receiver range	Refer to the How to reduce interference section
'Call In Fail' shown on display, with transmitter ID	Transmitter battery has expired	Replace transmitter batteries
Receiver does not respond to a transmitter	Transmitter not programmed to system	Refer to the Adding a transmitter section
Receiver does not respond to a transmitter	Transmitter battery has expired	Replace transmitter batteries
Receiver does not respond to a transmitter	Transmitter is not compatible with system	See appendix 1 for compatible transmitters
Receiver does not respond to a transmitter	Transmitter damaged	Replace transmitter or return to EMS for repair

Glossary

*	*Carrier received (precedes time on display)
Aerial Tamper	Aerial has been removed or tampered with Call In Fail Transmitter failed to call in three successive times (precedes Txer Details)
Call In Fail	Transmitter has failed to call in a first or second time (log event only)
I	RFI Detected after a period of 30 seconds (precedes time on display)
P	12Vdc PSU below 10.2Vdc, +/- 0.3Vdc threshold (precedes time on display)
R.F.I	Radio Frequency Interference.
System Clear	System now armed.
System Reset	System resetting outstanding events.
Test All TX	Test full alarm, local and tamper (where applicable) for each transmitter programmed to the system.

Appendix

Product number	Description	Options
7500 variants	Portable transmitter	Opposed action Non opposed Triple action Single action Dual action
7910	Moneyclip	Single action Dual action
7920	Contact operated transmitter	Alarm N/O Alarm N/C Local N/O Local N/C
7920/AS	Air switch operated transmitter	Single action
7920/PB	Push button operated transmitter	Single action
7920/PC	Pull cord operated transmitter	Single action
7930	Asset protection transmitter	Single action
7943	High power transmitter	Alarm N/O
7970	Pendant transmitter with chain	Dual action
7971	Pendant transmitter without chain	Single action
7972	Pendant transmitter with lanyard	Opposed action

Technical Specifications

Physical	Dimensions	H 195mm x W 296mm x D 110mm
Environmental	Weight	4 kg
	Temperature	-10 to +55 degrees C
	Humidity	Up to 75% non-condensing
Operating frequency		458.5 to 458.8 MHz channel spacing 25khz (MPT 1329)
RF sensitivity		-120 dBm for 12 dB sinad NBFM radio strength indication dynamic range of 60 dB AFC capture and hold +/- 3 KHz
Supply	Voltage	10 to 16Vdc
	Max current	250mA @ 12Vdc (with back light activated)
Inputs		Up to 256 wireless transmitters Up to 8 hardwired inputs
Outputs		4 programmable relay outputs 30V 28VA (1amp max) contacts RS485 bus port RS232 port
Standards	Complies with	BS4737 intruder alarm systems BS7042 high security intruder alarm systems BS6799 (up to class 5) wire free intruder alarm systems EN50131 class 2 grade 2 MPT1329 WT licence exempt BS8243 (when used in conjunction with BS8243 compliant wireless transmitters)



EMS Ltd.
Technology House
Sea Street, Herne Bay,
Kent, CT6 8JZ.

t: +44 (0) 1227 369570
f: +44 (0) 1227 369679
www.emsgroup.co.uk