

Syncro

Multi Loop Analogue Addressable Fire Control Panel

Product Manual

Man-1055 Issue 24 June 2013

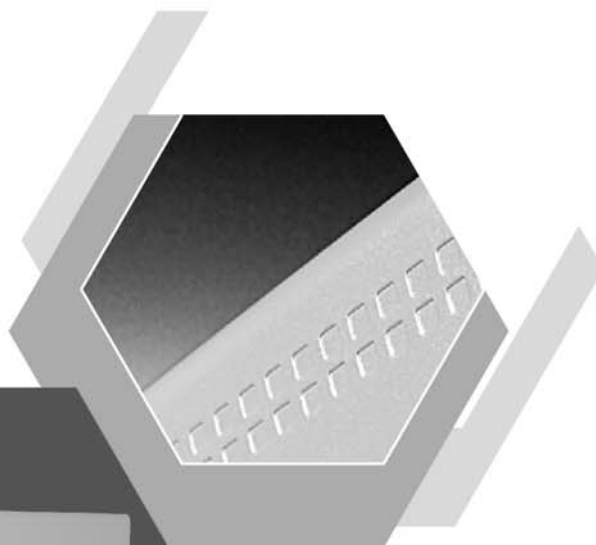

Section	Page
1. Introduction	4
2. Safety.....	4
3. Installation	5
4. Cabling	5
4.1 Loop Cable Termination.....	6
5. Connecting to the panel	7
6. Front panel controls	8
7. Powering the Panel	8
7.1 Configuration Data - Write Enable Switch.....	9
7.2 Configuring the Panel (Autolearn)	9
7.3 Configuring the Panel (from PC)	10
8. Facilities Menus.....	10
9. Detection circuits.....	11
9.1 Fitting additional detection circuits.....	11
10. Loop sounders & Beacons	12
10.1. Hochiki loop sounders.....	12
10.1.1 Volume settings.....	12
10.1.2 Tone settings.....	12
10.2. Apollo Intelligent loop sounders	14
10.3. Apollo Ancillary loop sounders	14
10.4. Argus Vega loop sounders.....	14
11. Panel Sounder circuits	15
11.1 Stage one and stage two delays.....	15
12. Sounder controllers.....	15
13. Relays.....	15
14. Monitored outputs.....	16
15. Extinguishant output	17
16. Remote control inputs	18
17. Power supply	19
17.1 Aux. 24V supply	19
17.2 Battery.....	19
18. Programming via a PC	20
18.1 Panel settings	20
18.1.1. Panel name	20
18.1.2. Panel address	20
18.1.3. Protocol	20
18.1.4. Number of loops	21
18.1.5. Default ringing mode.....	21
18.1.6. Access level code changes.....	21
18.1.7. CHQ-BS Loop Sounders	21
18.1.8. Panel text	21
18.1.9. Panel Modem Fitted.....	21
18.1.10. Graphics System	21
18.1.11. Day/Night times.....	21
18.1.12. Calibration time	21
18.1.13 Network Interface	21
18.1.14 Loop Sounder Options.....	21
18.1.15 Zone Indicator Offset (Syncro V5.70 or later, Syncro AS. V5 .20 or later).....	21
18.1.16 Any 2 devices to bypass OP delays (Syncro V5.40 or later, Syncro AS. V5 .15 or later).....	22
18.1.17 Resound alarm if fire in zone (Syncro V5.40 or later, Syncro AS. V5 .15 or later)	22
18.1.18 Delays active on initialisation (Syncro V5.70 or later, Syncro AS. V5 .20 or later).....	22
18.1.19 Hide Disablement Event for active displays.....	22
18.2. Inputs.....	22
18.2.1. Fire action.....	23
18.2.2. Fault action.....	23
18.2.3. Pre-alarm action	23
18.2.4. Tech. alarm action (Technical alarm).....	23
18.2.5. Evacuate action	23
18.2.6. Alert action	23
18.2.7. Security action.....	23
18.2.9. Reset action	24
18.2.10. Transparent action	24

18.2.11. Disablement action	24
18.2.12. Test mode action.....	24
18.3. Outputs.....	24
18.3.1. Evacuate Output	25
18.3.2. Def Ring Mode.....	25
18.3.3. Silenceable.....	25
18.3.4. Alert.....	25
18.3.5. Stage one delay.....	25
18.3.6. Stage two delay.....	25
18.3.7. Zoning.....	26
18.3.8. Location text	26
18.3.9. Tech alarm.....	26
18.3.10. Pre-alarm.....	26
19. Cause and effect programming	27
20. Optional printer	27
21. Networking	28
22. Modem.....	28
23. Panel Settings	29
23.1. Contrast Adjust	29
23.2. Network address setting	29
24. Panel specification summary	30
24.1. Recommended cables.....	30
24.2. Sounder Load.....	30
24.3. Current consumption.....	30
24.4. Power supply –.....	30
24.5. Field devices	30
24.6 Fire / Alarm / Fault / Relay 1 and Relay 2 ratings (see also Section 13)	30
24.7 Zones	30
24.8 Networking.....	31
24.9 Fire Routing and Auxiliary monitored outputs (see also Section 14)	31
24.10 Extinguishing monitored output (see also Section 15).....	31
24.11 Remote Control Inputs (see also Section 16).....	31
24.12 Auxiliary 24 Volt monitored output (see also Section 18.1).....	31
24.13 Fuse ratings	31
25. Additional Features	32
25.1. Loop Data Test	32
25.2. Network Panel Menu Control.....	32
25.2.1. Network Disablements	32
25.2.2. View Device Details on other panels	32
25.2.3. Global System Time	32
25.3. Configuration Transfer over Network	32
25.4. Contamination Status.....	33
25.5. Analogue value transfer.....	33
Appendix A – EN54 Configuration Requirements	34
Section 7 – Fire Alarm Condition	34
Section 8 – Fault Warning Condition	34
Section 9 – Disabled Condition.....	35
Section 10 – Test Condition.....	35
Section 12.5 – Integrity of Transmission Paths.....	35
Section 12.6 – Accessibility of indications and controls	35
Section 12.9 – Colours of indications	35
Appendix B - Internal controls.....	36
19. Internal controls and connectors	36
Appendix C - System Schematic Diagram	37

1. Introduction

The **Syncro** is an analogue addressable fire detection and alarm control panel capable of covering a maximum of 500 zones with up to 96 zonal LED indications at each panel with 2 or 4 detection loops and 126 devices per loop for Apollo protocol, 127 devices per loop for Hochiki protocol or 240 device per loop for Argus Vega protocol.

Syncro also supports loop-powered sounders.

Any number of devices can be allocated to any zone ensuring that any system configuration can be easily accommodated.

To ensure that the system is installed and commissioned with the minimum of trouble, it should be carefully planned before the installation is begun.

This involves allocating an address to each device and allocating a message of up to 40 characters (including spaces) to each address to assist in the location of the devices.

Devices should then be grouped into zones in accordance with the appropriate fire detection systems design standard and building plans.

The control panel can be configured using the switches on the front as described in the menu descriptions at the back of this manual or more comprehensively, using the Loop Explorer PC configuration utility and download lead which is available as a separate item.

A fire alarm call point should be located near the panel.

The **Syncro** control panel offers an extensive list of features and options for the control and monitoring of plant, equipment and sounders, which can be, configured via a PC configuration programme or the front panel controls.

In addition to the EN54-2 options with requirements below, the panel also supports facilities such as Day/Night sensitivity changes, programmable Function buttons and programmable auxiliary indications on the front of the panel.

The range of compatible devices includes optical and ionisation smoke sensors, heat sensors, multi-sensors, switch monitors and relay or bell controllers. Interfaces to conventional detection systems can also be catered for using zone-monitoring devices.

Each loop offers an addressing range from 1 to 127 (Hochiki), 1 - 126 (Apollo) or 1 – 240 (Argus Vega). However, devices such as the switch monitors and bell controllers have "Sub-addresses" in addition to their main address. Each panel can be configured to recognise up to 800 sub-addresses. These can be all on one loop or spread across 4 loops as required.

Therefore a switch monitor for example, may have a main address of 123, input 1 sub-address 123.1 and input 2 sub-address 123.2. (three addresses from 800 available).

The sub-addresses can be treated as if they were individual addresses i.e. each can be allocated to any zone, given an individual address message and be operated on by different cause and effect tables.

Important: This control panel should be used only with compatible fire system components. i.e. Apollo Series 90/XP95 or Discovery Protocol, Hochiki ESP Protocol or Argus Vega protocol.

The control panel has the following options with requirements as defined in BS EN54-2 : 1997.

- 1) Fault signals from points (clause 8.3)
- 2) Delay of the actioning of inputs and outputs (clause 7.11)
- 3) Disabling of each address point (clause 9.5)
- 4) Test condition (clause 10.1 to 10.3)
- 5) Control of Fire alarm devices (clause 7.8)
- 6) Co-incident detection (clause 7.12)
- 7) Output to Fire Alarm Routing Equipment (clause 7.9)
- 8) Output to Fire Protection Equipment (clause 7.10)

2. Safety

Suppliers of articles for use at work are required under section 6 of the Health and Safety at Work act 1974 to ensure as reasonably as is practical that the article will be safe and without risk to health when properly used.

An article is not regarded as properly used if it is used 'without regard to any relevant information or advice' relating to its use made available by the supplier.

This product should be installed, commissioned and maintained by trained service personnel in accordance with the following:

- (i) IEE regulations for electrical equipment in buildings
- (ii) Codes of practice
- (iii) Statutory requirements
- (iv) Any instructions specifically advised by the manufacturer

According to the provisions of the Act you are therefore requested to take such steps as are necessary to ensure that you make any appropriate information about this product available to anyone concerned with its use.

This equipment is designed to operate from 230V 50Hz mains supplies and is of class 1 construction. As such it **must** be connected to a protective earthing conductor in the fixed wiring of the installation. A readily accessible double pole disconnect device with a disconnect air gap of at least 3mm and conforming to EN 60950, shall be incorporated in the fixed wiring.

Failure to ensure that all conductive accessible parts of this equipment are adequately bonded to the protective earth will render the equipment unsafe.

3. Installation

Installation of the panel should be carried out by qualified personnel only.

The electronic components within the panel are vulnerable to physical damage and damage by electrostatic discharges.

It is advisable to wear a wrist strap designed to prevent the build-up of static charges within the body, before handling any electronic circuit boards.

Never insert or remove boards or components with the power on.

Mounting the Cabinet

The site chosen for the location of the panel should be clean and dry and not subject to shock or vibration.

The temperature should be in the range -5° to $+35^{\circ}$ C, the humidity should not exceed 95%.

Open the cover using the key provided.

Using the box as a template, mark the position of the fixing holes, ensuring that the wall is flat at the chosen location.

Screws or bolts of a minimum of 5mm diameter must be used to mount the enclosure in all four mounting positions.

4. Cabling

Cables should be brought into the cabinet using the knockouts provided and where necessary, using couplers to maximise the space within the enclosure. Use the knockouts closest to the terminating position for each cable, to ensure cable length within the enclosure is kept to a minimum.

Ensure that only the numbers of knockouts are removed to meet the cable termination requirements, as any additional apertures in the enclosure will compromise the IP30 ingress protection requirements required by EN54-2

Brass inlet bushings or cable glands should be used to maintain insulation and to ensure EMC compliance to the requirements of EN54-2

The screen or drain wires should be bonded to the earth terminals provided, ensuring that the shortest possible path is taken to the earthing block.

NOTE - All unused clamping screws on the earth terminal block shall be tightened after all cables have been installed. This is to ensure that they do not work loose or cause any panel failures as a result of vibration.

The maximum size of cable, which can be terminated, is 2.5^2 mm.

The communications protocol is highly immune to noise but sensible segregation from known noise generating sources such as mains cables is recommended.

Detection circuit cable size and type is dependant on the number and type of devices used and should be calculated for each installation. Cable length calculators are available for both Hochiki ESP and Apollo protocols.

Cabling for sounder circuits should be sized according to sounder load and cable length but 1.5mm^2 should suffice in the majority of cases.

The control panel requires a 230V AC supply, which should be derived from a separate fused spur, labelled "**Fire Alarm - Do Not Switch Off**".

The mains supply must include an earth conductor connected to the fixed installation earthing system of the building.

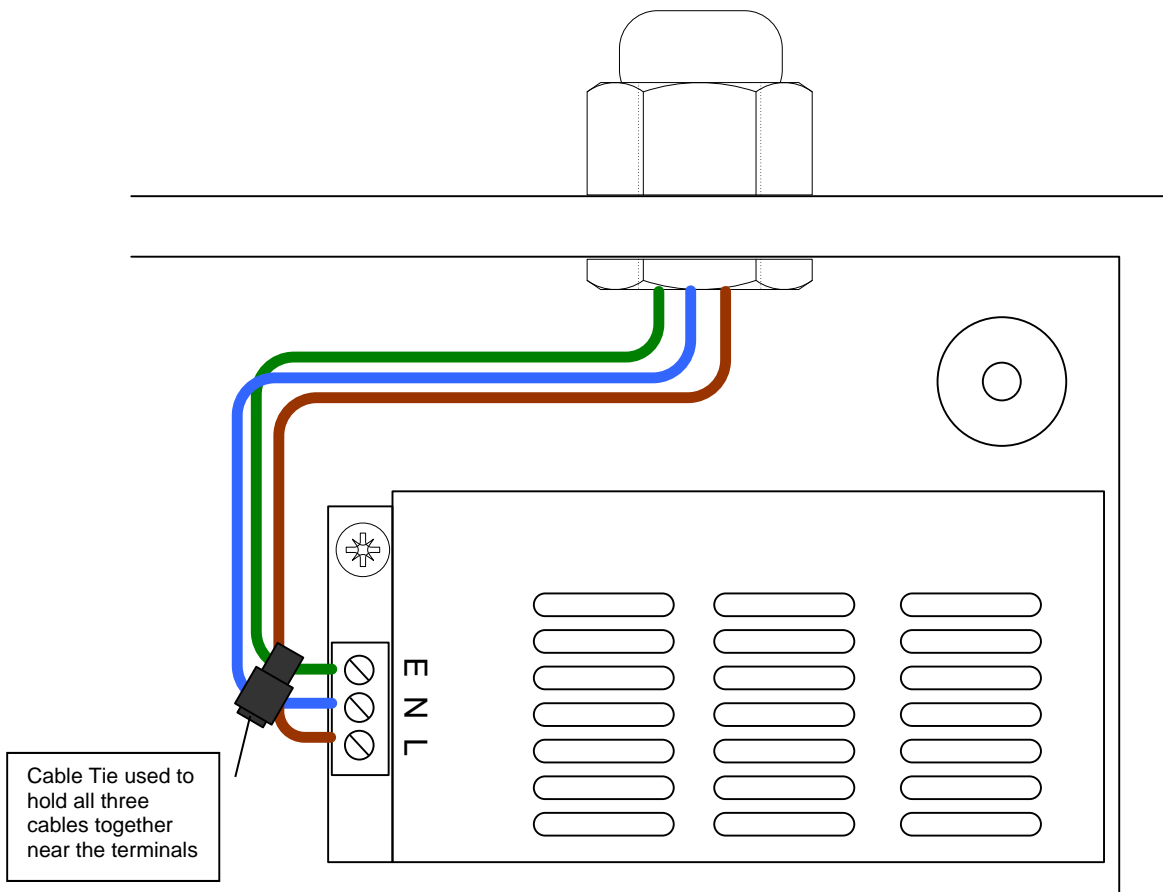

Mains cable termination

A cable tie should be installed around all three cables as near as possible to the power supply terminals. This will ensure that the cable will stay in place in the event of it becoming loose within its power terminal, thus reducing the risk of accidental damage or electric shock.

This equipment relies on the building installation for protection and requires a 5-amp protection device. The mains supply should use cable with a minimum cross section of 1.5mm².

4.1 Loop Cable Termination

Detection Loop drain wires need to be terminated at the brass cable gland to ensure EMC compliance to the requirements of EN54-2.

To ensure good earth bonding at entry to the panel enclosure, it is recommended that the cable drain wires are terminated using Pirelli AXT brass cable glands. These glands have a slotted fixing thread, which allows the drain wire to be clamped between the gland fixing nut and panel enclosure. To ensure that a good earth bonding between the drain wire and panel case, a 20mm shakeproof washer should be used, as shown in the termination diagram below.

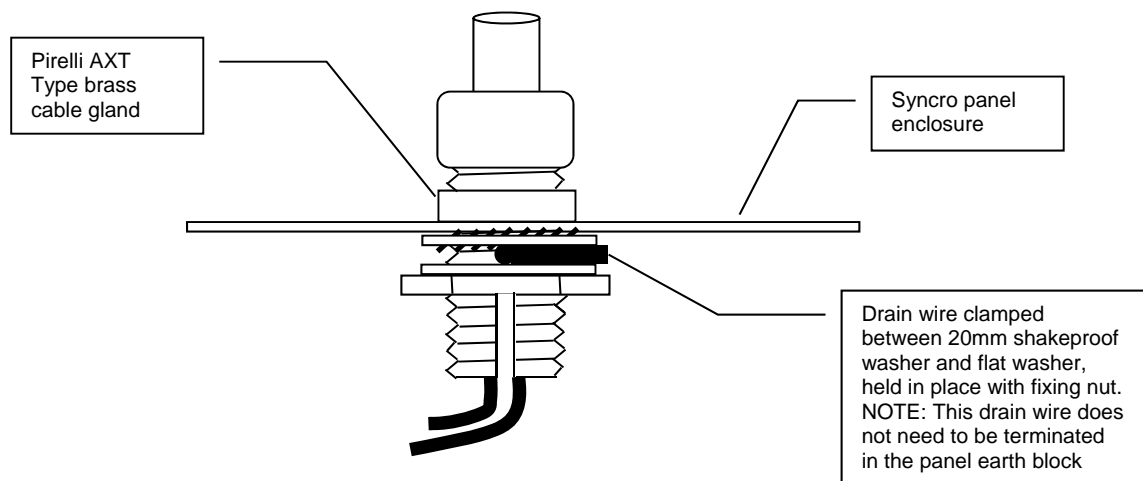

5. Connecting to the panel

All connections to the panel are via 5mm pitch, 2.5mm² capacity, spring leaf terminal blocks. Care should be taken to use the correct sized terminal screwdriver and not to over tighten the terminals.

To avoid the possibility of a confusing array of fault conditions, it is best to connect the system gradually, a loop at a time for instance, so that faults can be cleared on one circuit before connecting another.

Polarity must be observed carefully on any terminals with + or - markings and end of line devices must be fitted to all circuits which have them fitted in the terminals when the panel is supplied.

Do not connect or disconnect circuits with the power on.

Do not remove the protective cover from the terminal PCB.

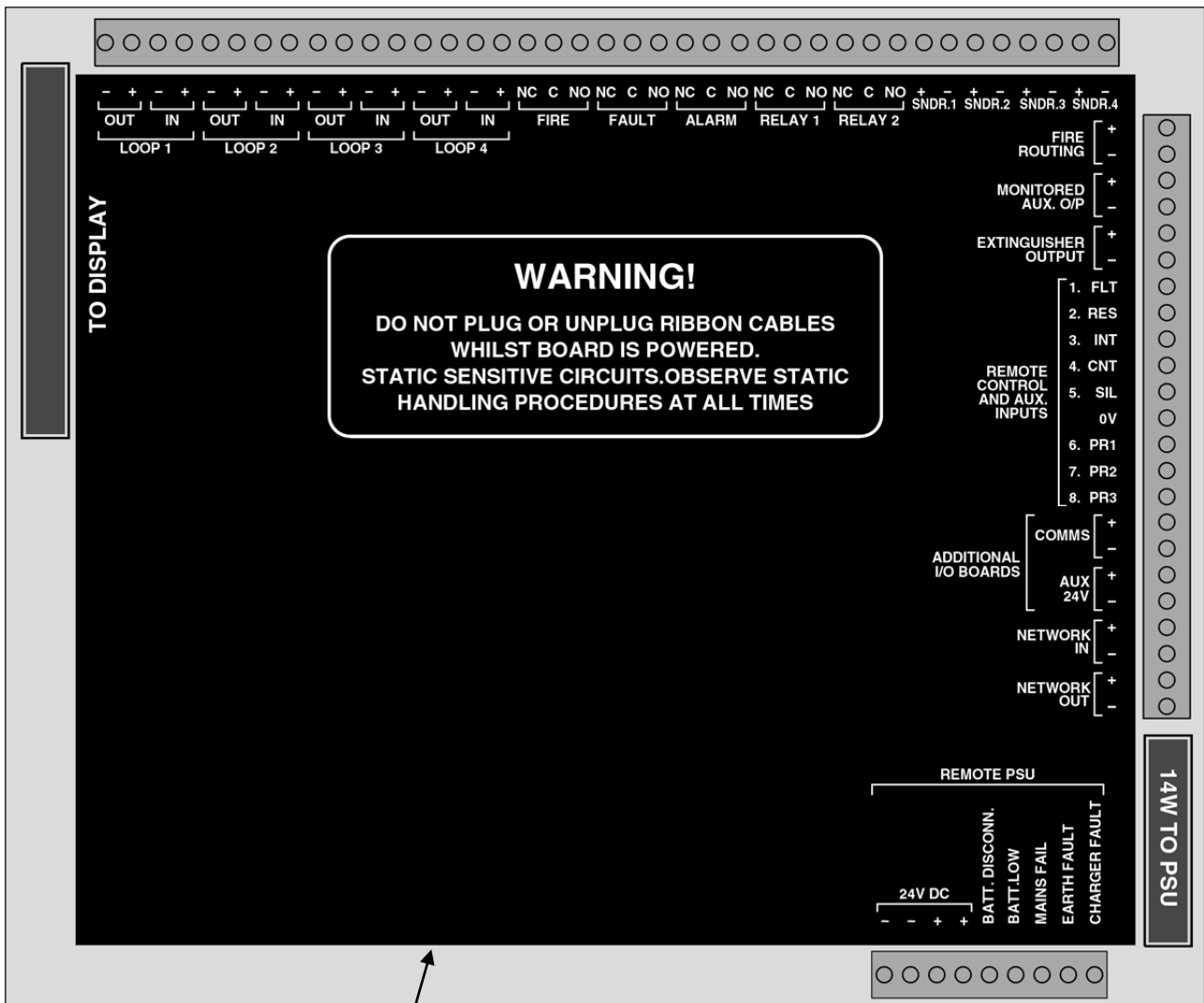

6. Front panel controls

The front panel contains controls for operating and programming the panel.

The lamp test and silence buzzer buttons can be operated at any time.

The More Fires and More Events buttons can be operated at any time when there are more events than can be displayed on the screen.

The menu navigation buttons can be used to enter the password to Access level 2 which then enables the Silence Alarm / Acknowledge, Resound Alarm, Reset and Function 1 and 2 buttons (used for controlling the panel) and gives the user access to the Access 2 menu facilities.

The Help (?) button offers additional information relating to the current status of the control panel. e.g. if the panel is in an alarm or fault condition then advice on the recommended action will be displayed or if a menu function is being accessed then help relating to that function will be displayed.

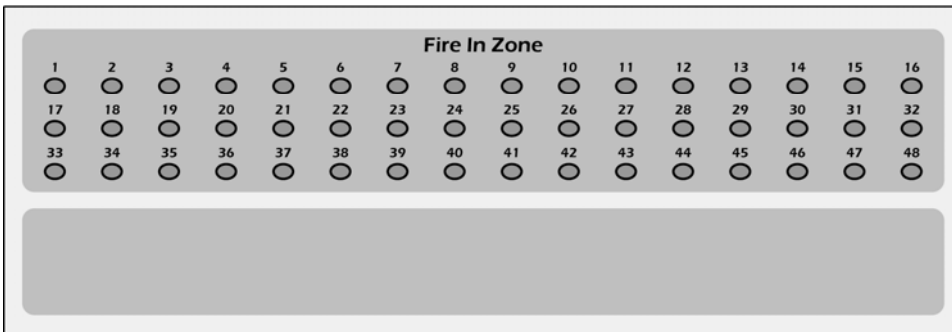
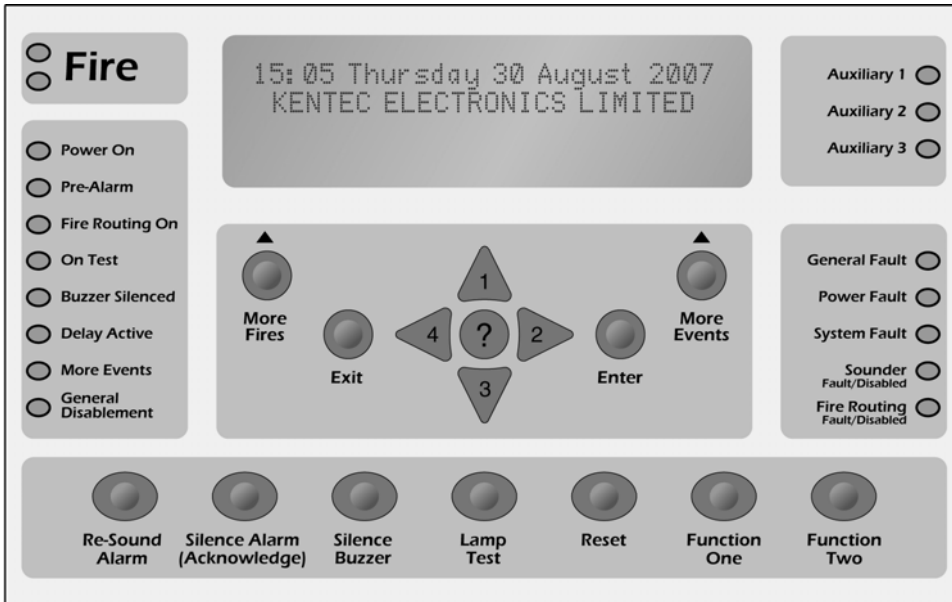

7. Powering the Panel

Ensure that the panel is free from swarf; wire ends, knockout discs and any other debris

NOTE: The battery cannot power the panel until the mains is first connected.

The polarity of the battery connection should be checked carefully before proceeding.

Ensure that each connection to loops, sounder circuits or any other inputs or outputs being used are correct before applying the mains power.

After applying mains power, connect the batteries.

7.1 Configuration Data - Write Enable Switch

Panels fitted with K6001 Issue 11 (or later) display cards have a memory "Write Enable" switch fitted. This switch is used to physically prevent the configuration memory contents from being changed.

Before making any changes to the panel configuration, it is necessary to ensure that this switch is in the "Enable" position. When left in the "Enable" position, a notification message will be given on the Syncro display.

It will not be possible to perform the Autolearn sequence or transfer a configuration into the panel from the PC (as described below) unless the configuration memory is Write Enabled.

It is also necessary to operate the write enable switch whenever any changes are made to the configuration memory using the Access Level 3 "Edit Configuration" or "Set Times" menu options.

7.2 Configuring the Panel (Autolearn)

When supplied the panel will contain no configuration and when power is first applied the display will show:

AUTO LEARN IN PROGRESS, PLEASE WAIT		
LOOP	NUM. DEVICES	INIT.
	PROGRESS	
1	000	0%
2	000	0%

Initialisation can take a few minutes to complete and the larger the number of devices on any one loop the longer it takes.

Panels fitted with Hochiki protocol will take significantly longer to initialise than those fitted with Apollo protocol or Argus Vega protocol.

At the end of the initialisation process, if there are no faults, the panel will beep and the "normal" display will be shown as below.

13:05 Monday 24 August 2009
AUTO CONFIGURED PANEL
USE ARROW KEYS TO ENABLE PANEL

On a system, which has been Auto learned, inputs, outputs and field devices will have been configured to the EN54-2 default settings.

It is quite common for mistakes to occur when addressing large numbers of devices and it is possible that some devices have been set to the same address.

The control panel can detect devices that have been set to the same address and will announce a "Double address" fault.

It is not possible for the control panel to tell which devices have been double addressed but to help find double addressed devices, go to the view devices option in the menu and make sure that all of the devices that are expected are listed.

If there is one double address fault and one device missing from the list of expected devices then it is fairly certain that the missing one is the one that has been addressed incorrectly.

It becomes a bit more tricky when there are more than 2 devices with the same address or more than 1 double address but using the principle above it will be possible to find the errors by a process of elimination.

It is always much quicker and easier to commission a system which has been addressed correctly and extra care taken to fit devices with the correct address to the plan will pay great dividends at this stage.

tip

If a fairly heavily populated loop is disconnected from the panel, the panel will obviously report all of the devices disconnected. Upon re-connection of the loop, the panel will find all of the devices again but it also has to run as a fire control panel, service other parts of the system and re-initialise these devices. In the case of a large number of faults under these circumstances it is often quicker to get the system back to normal by initialising the whole panel by pressing SW2 (RESET) on the front panel display PCB located on the rear of the panel door.

7.3 Configuring the Panel (from PC)

To allow configuration from a PC it is necessary to have the Loop Explorer configuration programme installed on the computer and for the download lead (Part Number S187) be plugged into the serial port of the computer. The other end of the download lead should be connected to connector J5 on the control panel front PCB.

For Computers that do not have a 9 pin serial port, a U187 USB converter will be needed.

When configuring the panel from a PC it is very important to ensure that the actual configuration of devices installed matches the PC configuration.

If this is not the case then there can be a bewildering array of missing and/or unexpected devices, which can be quite confusing and difficult to diagnose.

If the exact site configuration is not known in advance it is possible to upload an Auto Learned configuration to the PC, add text messages and any other changes required and then download this back to the control panel. This method ensures that the configurations match, is likely to proceed without errors and provides a quick and easy method of entering text and zone number information.

Panels that are configured from a PC can have default settings for devices changed (including call points) so the system should be thoroughly tested after a download to ensure that all devices respond as expected.

For detailed information on the facilities offered by the Loop Explorer configuration programme refer to the help files contained in the Loop Explorer programme

8. Facilities Menus

A number of facilities are provided which can only be reached at access level 2 or 3.

Access level 2 can be reached by entering the correct password (a 4 digit number) and pressing the enter button (or by the optional Enable Controls key switch).

Access level 3 can only be reached from access level 2 only by entering the correct password and pressing the enter button.

Panels that have not been configured, or have been configured using the Auto Learn option have 2222 as the default password for Access level 2 and 3333 as the default password for Access level 3.

Passwords can only be changed using the Loop Explorer PC configuration programme.

The Access level 2 password is required by the end user, to Silence / Acknowledge (and Resound) Alarms, to Reset the system and to gain access to the programmable Function 1 and Function 2 buttons.

Any persons responsible safety and have been trained and authorised to use the fire alarm system should be made aware of the Access Level 2 password (or given the enable controls key where applicable).

Without the Access Level 2 password it is not be possible to control the Syncro system so it is most important that the responsible person knows the password.

Main menu items available at access levels 2 and 3 are as follows:

ACCESS LEVEL 2 (2222)	ACCESS LEVEL 3 (3333)
Disablements	Edit configuration
View devices	Set times
Test Zones	View/print event log
Set system time	Print configuration
Contamination Status	Engineering Disablements
Access level 3	Loop Data Test

*******CAUTION*******

Access level 3 enables a much higher level of control and must be restricted to persons trained and authorised reconfigure the site-specific data and to maintain the Syncro panel. Typically engineers of the fire systems company will be responsible for Access Level 3 functions.

Before any changes are made to the configuration memory, using either the Edit Configuration or Set Times menu options, it will be necessary to set the memory write enable switch to the "Enable" position.

9. Detection circuits

Syncro control panels are supplied with 2 or 4 detection circuits and configured to communicate using either Hochiki, Apollo or Argus Vega protocol.

Panels that have no detection circuits are used as indicators of the status of other control panels on networked systems.

Devices are connected to the detection circuits on a looped pair of cables.

Short circuit isolators must be fitted in the loop wiring such that a single short or interruption in the circuit will not prevent the indication of a fire alarm from more than 32 detectors and/or manual call points. Argus Vega devices have built in isolators, so no additional isolators need to be fitted when using these devices.

Power is driven from the "out" terminals and is returned to the "in" terminals, where it is monitored for detection loop continuity.

If the loop is open-circuited (by cable fault or short circuit isolation), the panel will drive power from both the "out" and "in" terminals. This ensures that, despite a single break or short circuit in the wiring, all of the devices will still remain connected to the control panel. In the case of a short circuit, the short circuit isolators will isolate the faulty section of the wiring.

Both the "out" and "in" connections of the panel are fitted with short circuit isolation so that a short on the cable between these terminals and the first isolator fitted to the detection circuit will be isolated, leaving the remainder of the circuit operational.

The detection circuits also supply power to operate loop-powered sounders and can provide up to 400mA on each circuit.

As the power required by detectors, call points and input/output units is relatively very small, most of this power is available to drive sounders but the number of sounders which may be connected will depend on their volume setting and the number of other devices fitted. (see [section 10](#)).

Calculators are available for Apollo, Hochiki and Argus detection circuit loading and these should be used if there is any doubt about the loading exceeding the maximum of 400mA.

Detection loops should be wired in a screened fireproof cable (such as FP200) and terminated at the panel using brass cable glands. Hochiki protocol detection loops may be terminated by connection of the drain wires to the earth block within the control panel. Apollo detection loops should have the drain wire terminated at the cable gland, as described in [Section 4.1](#).

9.1 Fitting additional detection circuits

Control panels supplied with only 2 detection circuits can have an additional 2 detection circuits added at a later date if required.

These additional circuits must however be of the same protocol (Hochiki ESP, Apollo or Argus Vega) as the existing detection circuits.

The terminal board on all control panels has provision for connecting four detection circuits, but on 2-loop control panels, the electronic circuits to drive loop 3 and 4 are not fitted.

To fit the additional detection circuits the control panel must have mains and battery power removed.

The metal cover on the terminal board should then be removed by loosening the single fixing screw in the centre of the cover.

The circuit board containing the additional detection circuits is supplied in a static dissipative bag and should remain in this bag until it is to be fitted.

As with all electronic components, this circuit board is very sensitive and can be easily damaged by electrostatic discharge.

Where possible a static protective wrist strap should be worn when handling circuit boards. Where this is not available, it is advisable to touch a surface that is known to be connected to the earth of the fixed installation.

The loop board mounts on the left hand side of the terminal board and fits upside down compared with the existing circuit.

The additional 2-loop circuit board is supplied with 2 ribbon cables of different sizes and the board should be oriented so that the ribbon cables match the connectors. The ribbon cable excess should then be pushed between the boards.

There are four mounting pillars on the main board to which the additional 2-loop board should be fitted using the M3 screws and fibre washers supplied.

After checking that the new circuit board is firmly located and making good contact with its connectors, the metal cover should be replaced and fixed in position with the single screw.

Unused detection circuits must have the "loop + out" to "loop + in" and "loop - out" to "loop - in" terminals wired together to prevent open circuit faults from being reported.

Once the detection circuits have been connected, the devices for the new detection circuits can be automatically detected using the auto learn from the menu on the control panel.

10. Loop sounders & Beacons

The following graphs give an approximation of the number of sounders that can be connected to each loop at different volumes.

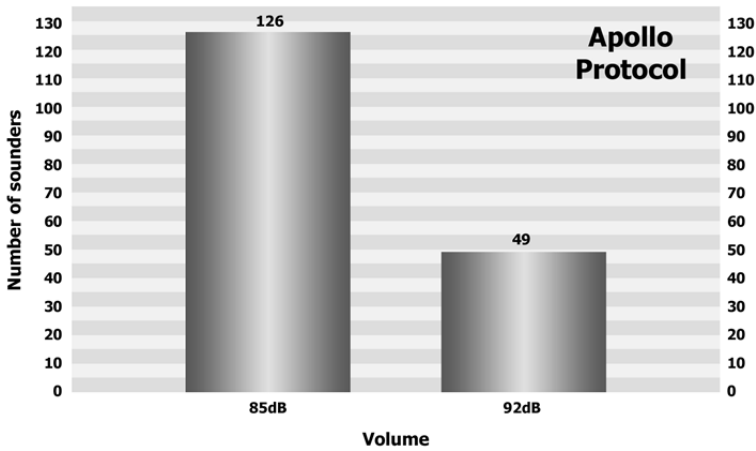

10.1. Hochiki loop sounders

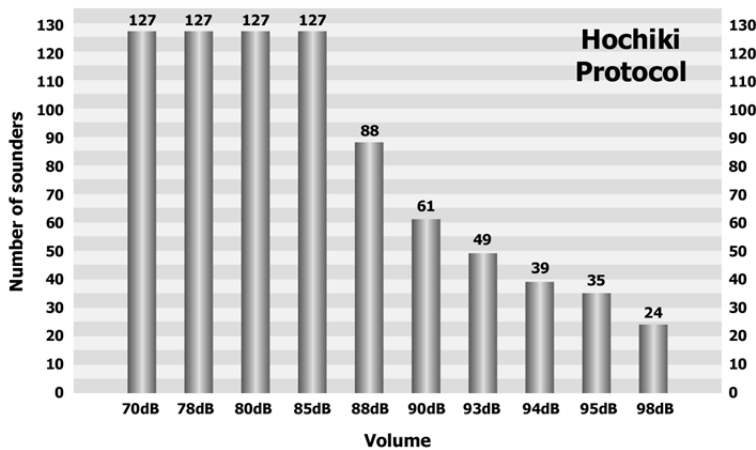

10.1.1 Volume settings

From the graph above, it can be seen that Hochiki sounders can have 10 volume settings.

Each sounder can have its volume set independently or all sounders can have the same volume setting by changing the default volume on the panel settings page of the PC configuration programme.

Unless this default volume setting is changed, all sounders will have a volume setting of 85dB.

This table shows the volume levels available and the current consumption at each volume setting. Loop sounders that are used as a detector base do not need to be allocated an address in the range 1 – 127. The Syncro panel will automatically address base sounders by adding 127 to the address of the detector to which they are connected during the panel initialisation process. This means that it is possible to fit 127 detectors and 127 base sounders to a loop.

It is possible to alter the address of base sounders but the address will revert to 127 above the host sensor address at calibration time (which is every 24 hours) or at every re-initialisation, so there is no point in doing this.

Wall sounders however must be addressed in the address range 1 to 127, using a hand held programmer, and will retain their address setting at all times.

VOLUME	CURRENT
70dB	0.8mA
78dB	1.5mA
80dB	2.0mA
85dB	3.0mA
88dB	4.5mA
90dB	6.5mA
93dB	8.0mA
94dB	10mA
95dB	11mA
98dB	16mA

Because each loop sounder has its own address, it is possible using the PC configuration programme (Loop Explorer) to perform cause and effects on each sounder or groups of sounders as required. This gives great scope for controlling the annunciation of the fire alarm for all types of building.

10.1.2 Tone settings

It is possible to change the tone of all or individual, Hochiki loop sounders, to one of 51 different tones.

Each event type has been allocated a separate default tone and these may be changed from the default to any of the 51 tones by selecting the "Loop Sounder Options" tab from the panel settings window.

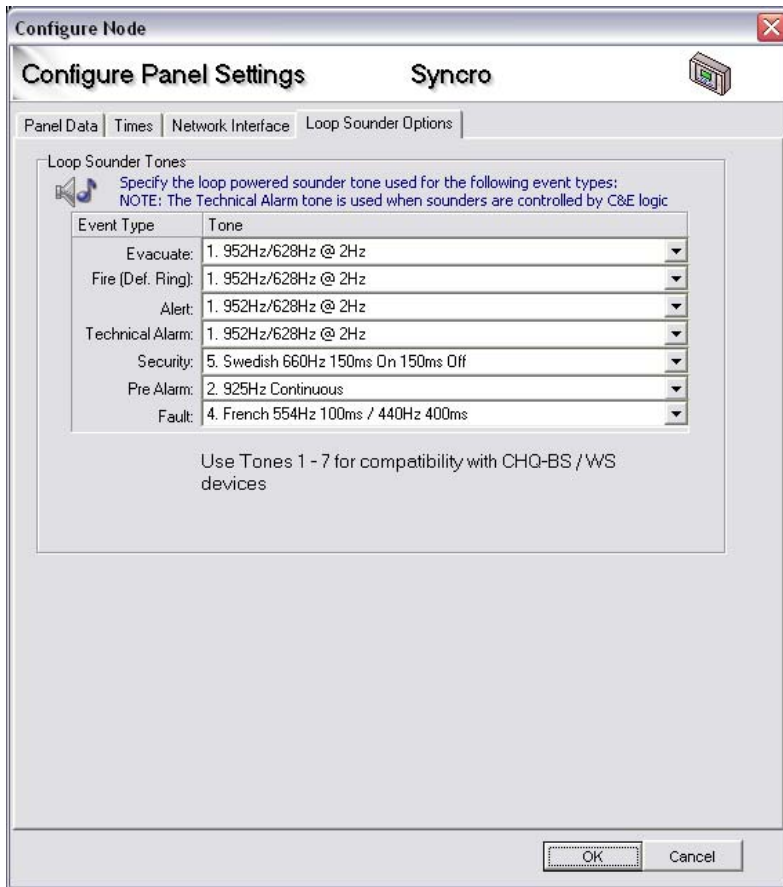

The window above shows all of the event types and their default tones. All or any of these may be changed to another tone and it is possible for more than one event type to use the same tone.

Loop sounders will default to operation upon a fire condition. It is possible however, to operate loop sounders upon any of the seven event types. It is also possible to operate loop sounders upon more than one event although under these circumstances a hierarchy exists as follows:

- EVACUATE
- FIRE
- ALERT
- TECH ALARM (*includes sounders controlled by Cause & Effects*)
- SECURITY
- PRE-ALARM
- FAULT

As can be seen from the above, a loop sounder which is sounding a TECH ALARM will change its tone in the event of EVACUATE, FIRE or ALERT events if it is programmed to respond to all of these.

Loop sounders can be programmed to operate upon any of the event types using the configure settings window as shown below. This window also allows the volume of the sounder to be changed from the default value, stage 1 and stage 2 delays to be set and the sounder to be selected Silenceable or not as required.

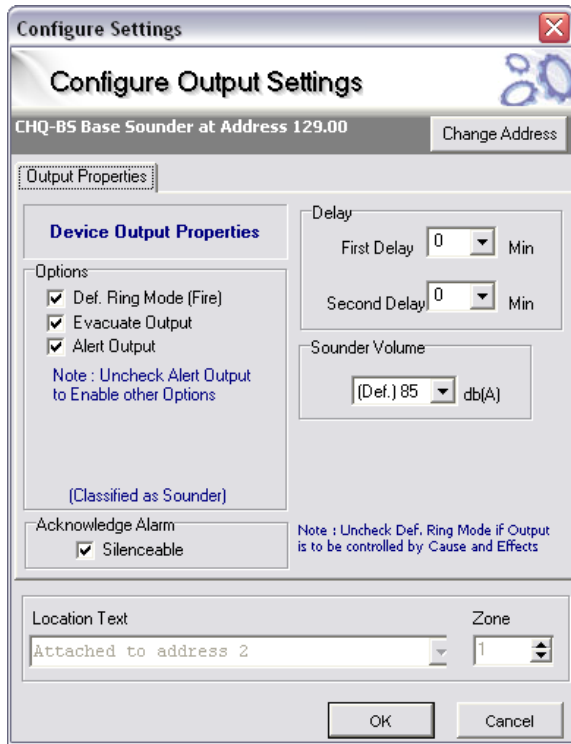

NOTE: If a loop sounder is controlled by a cause and effect operation, then the Tech Alarm tone will be used when the sounder is energised.

The possibility to change tones allows the fire alarm infrastructure to be utilised to a much greater extent for other types of audible signalling than simple pulsing or steady sounder systems.

For class change applications as an example, different tones could be used to signal class change and break times. This could also apply to the factory environment to signal break and shift changes.

The ability to operate individual sounders from dedicated inputs also allows the system to be used for fire door monitoring such that the sounder nearest the door can emit an alternative tone if the door is opened in a non-emergency situation.

10.2. Apollo Intelligent loop sounders

Apollo Intelligent loop sounders can have two volume settings. Operating a bit on the address DIL switch on the device sets the volume.

The volume settings available are 85dB at which the current consumption is 3mA and 92dB at which the current consumption is 8mA.

The sounder can be operated with only one tone, which is 500Hz/550Hz at 250mS intervals. This can be pulsed at 1-second intervals to give an alert warning if required.

Apollo loop sounders can be used as a detector base or as a stand-alone device but either way, each sounder must be allocated a unique address in the range 1 to 126.

10.3. Apollo Ancillary loop sounders

Apollo Ancillary base sounders are controlled by the remote indicator output of their host detector. As these sounders are not addressable devices, the Syncro panel will not be able to identify the device during the auto learn sequence.

Therefore it is necessary to configure the Syncro panel to advise it that certain detectors have Ancillary Loop sounders installed. These devices are added to the system configuration file using Loop Explorer and are seen as phantom addresses at the detector address + 126.

The ancillary base sounders can be configured to respond to all output properties except for the Alert option, as the sounder cannot be pulsed.

10.4. Argus Vega loop sounders

Argus Vega loop sounders have a rotary volume control located within the sounder.

The volume is variable from 90dB at which the current consumption is 4mA to 100dB at which the current consumption is 7mA.

The Argus Loop sounders can be selected to three different tones. Each event type has been allocated a separate default tone and these may be changed from the default by selecting the "Loop Sounder Options" tab from the panel settings window. The tones may be set to 800/970Hz warble, 970Hz continuous or 970Hz intermittent.. This can be pulsed at 1-second intervals to give an alert warning if required.

Argus Vega loop sounders can be used as a detector base or as a stand-alone device but either way; each sounder must be allocated a unique address in the range 1 to 240.

11. Panel Sounder circuits

Four conventional sounder circuits are provided in the panel, each fused at 1.0A. Total load for all monitored outputs must not exceed 2.0A.

Fitting a 10K end of line resistor monitors the circuits for open and short circuit faults.

All circuits are configured to activate upon any fire condition and to de-activate when the Silence Alarm / Acknowledge button is pressed on the front panel or a silence input is operated.

Each sounder circuit can be configured independently via the PC configuration programme or the front panel pushbuttons (at Access level 3).

This allows sounder circuits to be operated by different methods such as zonal alarm or via cause and effects.

11.1 Stage one and stage two delays

The sounder circuits can have a single or two-stage delay if required. The first stage of delay allows up to 5 minutes for the alarm to be acknowledged.

If the alarm is not acknowledged before the first stage delay expires, then the sounders will operate.

If the alarm is acknowledged during the first stage delay, the second stage delay (again up to 5 minutes) will start.

If the alarm is acknowledged during the first stage delay and the second stage delay is zero then the sounders will not operate.

If the Alarm is acknowledged during the second stage delay, the second stage delay (up to 5 minutes) will start and the sounders will operate at the end of the delay unless the panel is reset.

Activation of two or more devices producing a fire action, a call point or an input configured to override output delays, will override the delays and operate the sounders immediately.

12. Sounder controllers

Sounder controllers are available in the Hochiki, Apollo and Argus Vega range of devices and can be used for controlling conventional sounders from the detection loop.

The wiring to the conventional sounder circuits is monitored for open or short circuit faults by fitting an end of line monitoring device.

The sounder controller outputs are fully programmable as described in [section 11](#) and [section 19](#).

Sounder controllers require an additional 24V DC supply to power the conventional sounder circuits (or other equipment). This power supply is also monitored for failure by the control panel.

13. Relays

Volt free changeover relay contacts rated at 30 Volts DC at 1 Amp are provided for ancillary switching functions in all panels.

Under no circumstances should voltage or current outside of this limit be used with these contacts.

The default actions of these contacts as supplied from the factory are as described below: -

NAME	ACTION
FIRE	Activates on any fire condition and remains active until panel is reset
FAULT	Activates on any fault and clears when faults are cleared
ALARM	Activates on any alarm, de-activates when alarm silenced / acknowledged
RELAY 1	Default action is closed for 5 seconds when reset button is pressed
RELAY 2	Default action is closed for 1 second upon every new fire event

Each volt free changeover contact can be configured independently via the PC configuration programme or the front panel pushbuttons (at access level 3).

This includes delays as described for the sounder circuits above.

14. Monitored outputs

In addition to volt free contacts, outputs are provided for FIRE ROUTING and MONITORED AUX. O/P.

Both outputs are monitored for open and short circuit fault conditions by fitting a 10K end of line resistor at the receiving end.

They operate on the voltage-reversing principal similar to that used for sounder circuits so the receiving end equipment must be polarised and suppressed. Each output is protected by a 500mA self resetting electronic fuse.

These outputs are provided to allow signalling to remote fire alarm equipment such as a dialler to call the fire brigade.

These outputs can be re-programmed to operate differently to their default setting if required via the PC configuration programme or the front panel pushbuttons (at access level 3).

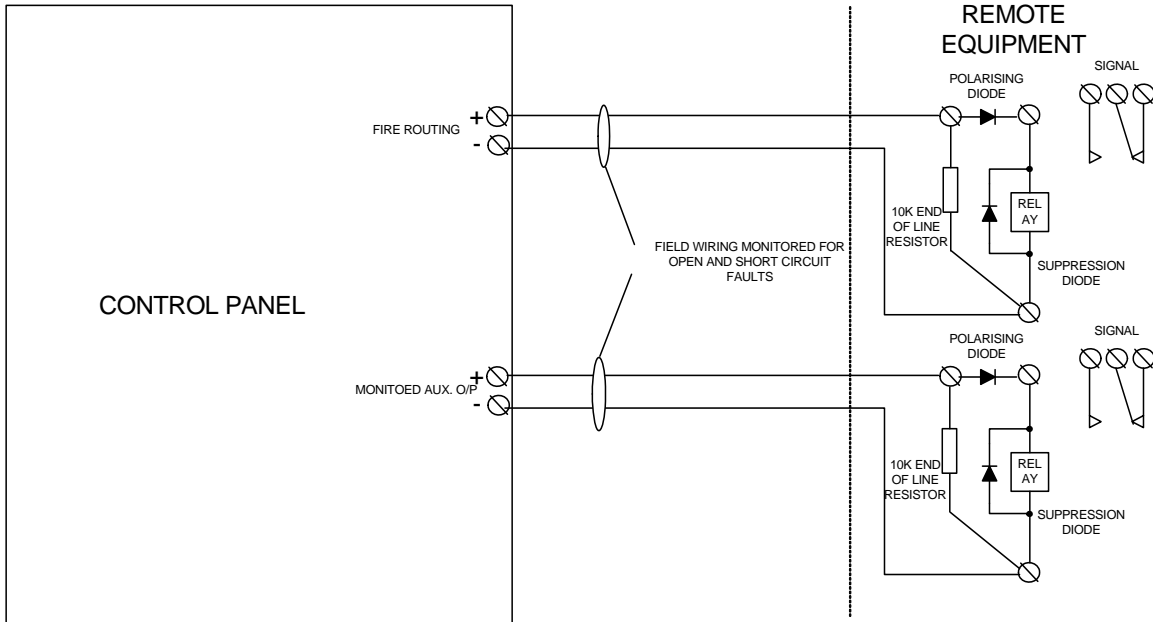

Connections to the remote equipment should be as shown above. It is important if the device at the receiving end is an electromagnetic device such as a relay that polarising and suppression diodes are fitted to prevent operation of the device in the normal condition and to suppress any interference generated by the device when it operates.

15. Extinguishant output

The control panel is also equipped with a monitored output, which may be used to activate an Extinguishant system solenoid or explosive actuator directly.

The output is not configured to operate at all when the panel is supplied (for safety reasons) but may be configured via the PC configuration programme to operate in response to cause and effects.

This would typically be coincidence from a group of detectors in a particular room or area, which is being protected by Extinguishant agent.

The Extinguishant output is fitted with a 1.1 Amp self-resetting electronic fuse.

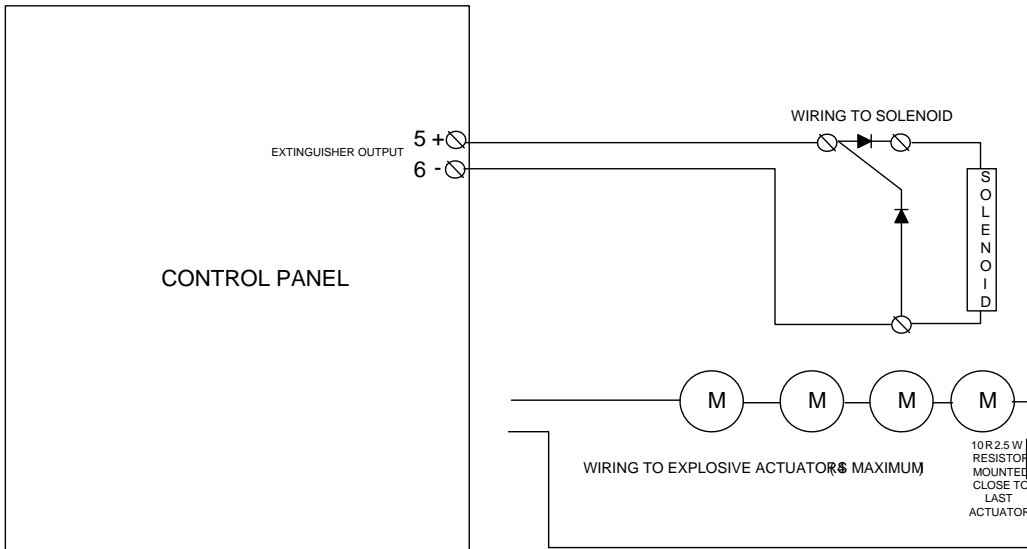

To enable monitoring of devices such as Metron actuators which have a very low resistance, the short circuit threshold level needs to be adjusted to suit. To do this, first remove the cover from the K6002 PCB mounted on the back chassis by removing the single screw that hold the cover in place and put the screw and cover aside.

With the end of line diode only fitted to the terminals, locate the adjustment control as shown in the drawing below and turn it fully anti clockwise until a click is heard indicating that the control has reached the end stop. Now turn the adjustment control 3 full 360 degree turns clockwise. Put the panel to access level 2 and press the reset button. Now apply a short circuit and ensure that an appropriate fault is displayed.

Once the actuator devices are fitted, repeat the procedure above. And turn the adjustment control clockwise by half a turn increments until the panel is fault free and will show a fault if a short circuit is applied to the extinguishant output.

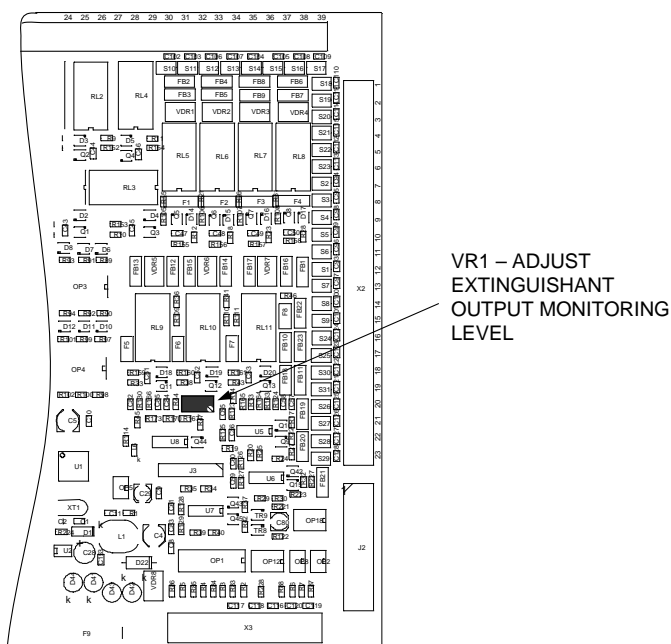

16. Remote control inputs

Eight inputs are provided in the panel, which have default actions as described in the table below:

INPUT	DEFAULT ACTION
FLT	Operates outputs configured to operate on fault condition.
RES	Resets the control panel
INT	Operates all sounder outputs intermittently
CNT	Operates all sounder outputs continuously
SIL	Acknowledges the alarm (silences all sounders)
PR1	No action
PR2	No action
PR3	No action

NOTE: The RES / INT / CNT / SIL inputs should only be available at Access Level 2. Care must be taken to ensure these inputs cannot be operated without some form of access control in order to maintain conformity to EN54-2

All inputs can be re-programmed to have a different action, delay, zone and location message using the PC configuration programme or front panel (at Access level 3)

To activate the inputs, the 0V connection is connected to the input(s) as shown below.

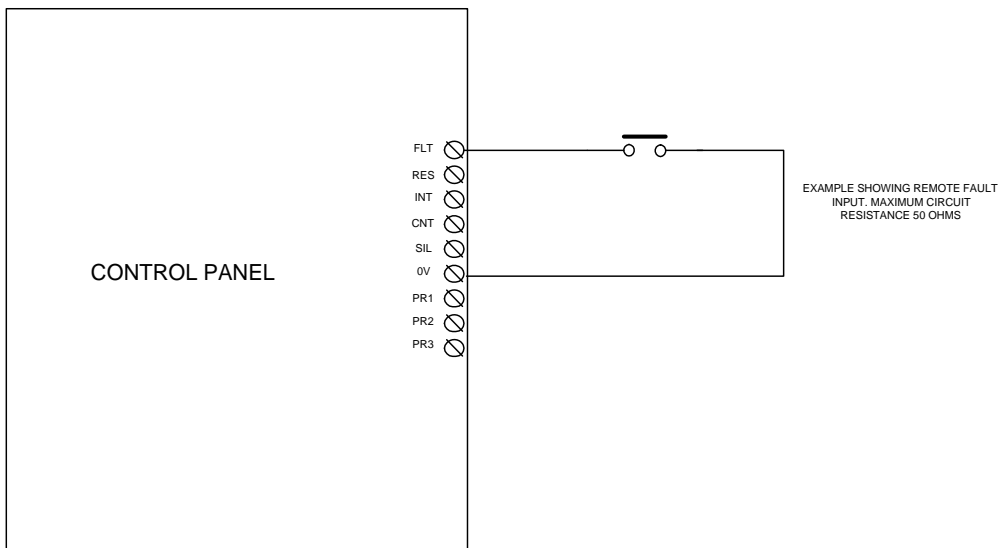

All inputs are non-latching as default.

The line impedance should be less than 50 ohms for reliable operation.

The control panel has a communications bus to which additional I/O boards may be connected. The I/O boards have 16 channels, each of which can be individually configured using the Loop Explorer configuration programme to be an input or an output.

Inputs to these boards are via opto-isolators, which offer good protection against noise and transient phenomena. Channels configured as outputs use an open collector transistor, so must be used with care to avoid damage.

Full application details for the I/O boards are available in a separate manual.

Up to 32 of these 16 channel I/O boards can be fitted to each panel and all of the inputs and outputs are configurable in the same way as inputs and outputs on devices connected to the detection circuits or directly connected in the Syncro panel.

The inputs (outputs) may contribute to (be controlled by), cause and effects in the same way as the devices connected to the detection circuits giving them great flexibility in monitoring and control applications.

An auxiliary 24 V DC power output is provided in the control panel, which can be used to power the I/O boards. This is limited in the amount of current that it can supply and for I/O boards mounted away from the control panel, a separate power supply is recommended.

17. Power supply

The control panel is fitted with an EN54-4 approved 4 Amp power supply and battery charger.

The power supply can supply 4 Amps to power the panel while supplying up to 1.25A to charge batteries.

The power supply is microprocessor controlled and incorporates monitoring of the condition of the power system. The battery charging output is temperature compensated to maximise the service life of the batteries. A deep discharge prevention circuit will disconnect the batteries if they are in danger of going below the point where they cannot be recovered by normal charging. A resistance greater than 1 ohm introduced into the battery charging circuit will be indicated as a battery impedance fault.

The following fault conditions are signalled to the control panel: -

MAINS FAILED
BATTERY DISCONNECTED
BATTERY LOW VOLTAGE
BATTERY HIGH IMPEDANCE
EARTH FAULT
CHARGER FAIL

The power supply has LED indicators fitted to indicate the fault condition internally in addition to the indication given on the display of the control panel.

The mains fuse fitted is a 3A F2 250V HRC 20mm type and must be replaced upon failure with a fuse of the same type to maintain the safety rating of the power supply.

If the power supply is overloaded it will be shut down by an internal thermal protection circuit, which will not reset until the mains supply is removed for 5 minutes and then re-applied with the overload disconnected.

The control panel can not be powered by batteries until the mains supply is connected but once running the mains supply can be disconnected leaving the panel running on battery power alone.

The power supply is fully protected against short circuits, overloads and battery reversal and can supply the full 4 Amp load indefinitely.

17.1 Aux. 24V supply

A separately fused auxiliary 24 Volt output is provided on the terminal board for powering additional I/O boards or other equipment connected to the fire alarm system.

The fuse is of the self-resetting type and is rated at 500mA. Failure of the fuse is monitored by the system and announced as "Aux. 24V fuse failed".

The impact on battery standby duration must be carefully considered when using the Aux 24 volt output. Constant use of the full 300mA capability of this output for instance would require an additional 9Ah of battery capacity.

Ideally, use of the Aux. 24V output should be restricted to powering additional I/O boards or switching equipment when an alarm condition occurs,

The impact on battery standby should be considered in all cases.

17.2 Battery

To enable the system to continue to function in the event of a failure of the mains supply, re-chargeable batteries must be fitted. These are not supplied with the control panel.

Batteries should be of the re-chargeable, sealed lead acid type. They should be new and sized according to the local codes of practice for the standby period required, preferably by measuring quiescent and alarm loads for the particular hardware configuration.

This table gives typical battery sizes under normal loading but does not take into account additional I/O boards or use of the Aux. 24 Volt output. Systems using these facilities should have their battery size calculated according to the additional information below.

PANEL TYPE	BATTERY SIZE REQUIRED		
	24 HOURS	48 HOURS	72 HOURS
NO LOOPS	7Ah	12Ah	15Ah
2 LOOPS	12Ah	24Ah	36Ah
4 LOOPS	12Ah	24Ah	36Ah

The maximum size of battery, which can be fitted inside standard control panels, is 12Ah (2 x Yuasa NP12-12)

12V, 12.0Ah).

The Syncro power supply can support up to 26Ah batteries, however for the standard size enclosures, these must be installed in a separate enclosure mounted immediately adjacent to the control panel. The cable path between enclosures must be mechanically protected to prevent any possible damage to the battery leads.

The 500mm x 460mm x 190mm "size 15" style panels can accommodate up to 24Ah size batteries within the panel enclosure.

Batteries above 26Ah will need to be fitted in a separate enclosure and charged by a suitably rated battery charger

Any additional load connected to the system through the Aux. 24V output should be catered for by additional capacity using the formula below:

$$\text{Load (mA)} + 25\% \times \text{Standby period (hours)} = \text{Ah.}$$

This figure should be added to the battery capacity required and the next available size selected.

18. Programming via a PC

Due to the use of the very latest microprocessor and memory technology, the Syncro fire control panel is an extremely powerful machine.

As such, it can be programmed in an almost infinite number of ways, some of which will not give the visual and audible indications expected from a fire system.

Any re-programming from the factory default settings must therefore be carried out by competent fire systems engineers and thoroughly tested against the system plans before final commissioning.

Although the Syncro is very powerful and can be programmed to perform some complex tasks, the principals adopted in the way that inputs and outputs are handled make it conceptually very simple.

18.1 Panel settings

When panels are supplied, they are configured with the loop protocol and number of loops and zones as ordered.

There are a number of other attributes, however, which can be changed using the configuration programme as shown below.

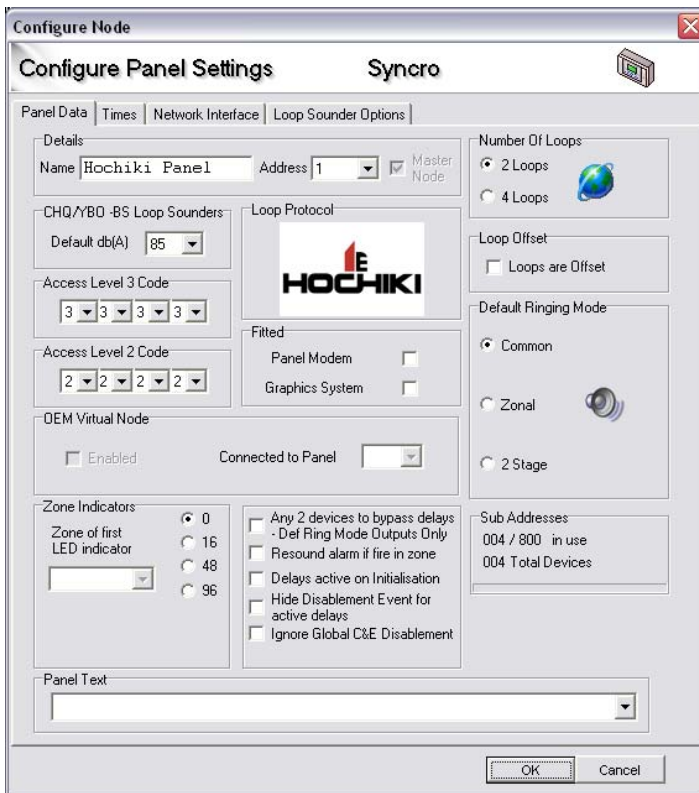

18.1.1. Panel name

By default the panel name will be set to match the protocol that the panel is configured to communicate with. I.e. Apollo panel, Argus Vega panel or Hochiki panel.

If the panel is part of a network of panels, it can be useful to have a panel name, which would normally describe its location such as the name of the building or facility where the panel is mounted.

The panel name can be up to 15 characters long.

18.1.2. Panel address

To enable control panels to know about each other when connected to a network, each panel must have a unique address. This is the node address and should be a number between 1 and 64. Syncro panels that do not have a network card installed will always default to address 1.

18.1.3. Protocol

Control panels are supplied as either Hochiki, Apollo or Argus Vega compatible.

The label inside the control panel showing the part number identifies which protocol is being used by starting with either an H (Hochiki) , an A (Apollo) or a V (Argus Vega).

When making a configuration file, the correct protocol must be selected when a panel is added to the configuration file. Repeater panels are protocol independent.

18.1.4. Number of loops

Control panels are supplied with 2 or 4 detection loops fitted. The configuration file should be created with the same number of loops as the control panel for which it is destined.

The Syncro Response repeater panel has no detection loops fitted, and is protocol independent. This panel option may be selected when adding panels to the configuration only.

18.1.5. Default ringing mode

When control panels are supplied, the default-ringing mode is set to common alarm. In this mode, any fire condition will operate all sounders continuously.

The mode can be changed to zonal alarm, which means that only sounders in the same zone as the signal that originated the alarm will operate.

A third option of 2-stage alarm is also available which causes the sounders in the same zone as the signal that originated the alarm to operate continuously and sounders in all other zones to operate intermittently.

18.1.6. Access level code changes

The default access codes to level 2 and level 3 can be changed via the configuration programme only.

18.1.7. CHQ-BS Loop Sounders

For Hochiki systems, it is possible to select the default volume of CHQ-BS loop powered sounders. Each sounder may be configured independently to either the default setting or one of 10 volume settings.

NOTE: Volume settings of CHQ-WS 100dB wall sounders may not be configured from the control panel, even though this device has the same type code as the CHQ-BS loop sounder.

This option is not available for Apollo or Argus Vega systems, as the volume can be adjusted only by setting a control on the device.

18.1.8. Panel text

A forty-character message can be entered which is displayed when the control panel is in a quiescent condition. This may be the company name and service contact number or any other message agreed with the end user.

18.1.9. Panel Modem Fitted

When selected, the panel expects a modem to be fitted to the PC port of the display PCB. The panel will poll the modem at 90-second intervals and expect a response from the modem. If the modem does not respond, then a disconnected modem message will be shown on the panel display.

18.1.10. Graphics System

When this is selected, event cleared messages will be sent to the PC port and printer port. This allows a graphics system to track events and automatically clear events, provided this facility is supported by the graphics system. This is deselected by default, to reduce printer paper consumption. When selected, event cleared messages will be printed after each event or activation has been reset

18.1.11. Day/Night times

The sensitivity of detectors can be varied during a 24-hour period. This is commonly known, as Day/Night mode but can be either or both as any period in any 24 hours can be selected as day or night.

Day night change times can be set for each day of the week on the additional tab on the panel settings screen.

18.1.12. Calibration time

All sensors are re-calibrated every 24 hours. This time is selectable, so that sensors are not calibrated at a time when there is a high background pollution level. The calibration time should be set to a time when the building is quiet, with little air movement.

18.1.13 Network Interface

In a networked system, each panel can be configured to respond to individual event types from any other panel on the system. This is configured at this point.

See the Syncro Networking Manual for more details on the selection.

18.1.14 Loop Sounder Options

This is detailed in [Section 10](#) of this manual.

18.1.15 Zone Indicator Offset (Syncro V5.70 or later, Syncro AS. V5 .20 or later)

The Syncro system is capable of hosting up to 500 zones however; panels are available as standard fitted with 0, 16, 48 or 96 zones.

For networked systems which require each panel to display unique zones at each panel, an offset can be applied such that for instance, panel 1 displays zones 1 to 96, panel 2 displays zones 97 to 192 and so on.

To set this functionality, first check the number of zone indicators that the panel has fitted (0, 16, 48 or 96) and then select the number for the first zone on the panel from the drop down box.

18.1.16 Any 2 devices to bypass OP delays (Syncro V5.40 or later, Syncro AS. V5 .15 or later)

When selected, this feature will enable delays to outputs to be overridden whenever any two detection devices are in a fire condition. These devices may be in the same or different detection zone and can be on different panels on the network.

18.1.17 Resound alarm if fire in zone (Syncro V5.40 or later, Syncro AS. V5 .15 or later)

The default operation of the Syncro panel is that for a fire in a detection zone, the sounder outputs will operate. If the sounders are then silenced and then there is a second fire event from another detection device in the same zone, the sounders do not resound.

Selecting this option enables previously silenced sounders to resound upon a second detection device fire in the same zone.

18.1.18 Delays active on initialisation (Syncro V5.70 or later, Syncro AS. V5 .20 or later)

In order for configured delays to outputs to be active, the "Disable Immediate Output Response" menu option must be selected. However, in the event of a panel being rebooted the disablement events will be cleared. This may result in the accidental operation of sounders immediately following a fire condition.

Selecting this configuration option ensures that after a panel has been rebooted, the "Disable Immediate Output Response" option is selected by default, with no user intervention.

18.1.19 Hide Disablement Event for active displays

The EN54-2 requirement for delays to outputs are that the delay should be configured at commissioning, yet may be switched off and on by the user at Access Level 2. The standard also requires that when the delays are active, a disablement event is shown on the control panel as well as the additional "Delay Active" indicator.

The disablement indication is often interpreted that a part of the system is not working, rather than intentional delays to outputs being selected.

Selecting this configuration option suppresses the disablement indicator when the "disable immediate output response" menu option is selected.

In this case, only the delay active indicator will be lit.

NOTE: This feature does not conform to the requirements of the current EN54-2 when selected.

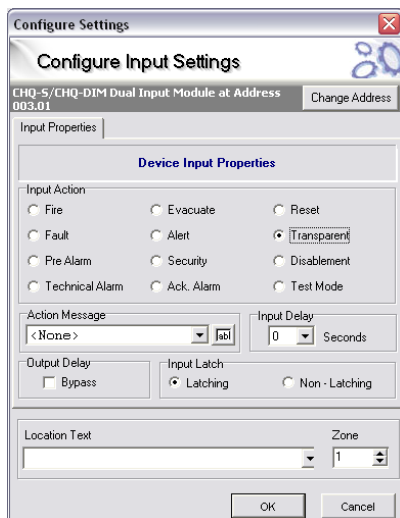

18.2. Inputs

The basic principle is that all inputs are handled in exactly the same way, whether they are from a field device, a programmable input on the panel, a 16 channel I/O board or indeed one of the programmable pushbuttons on the front panel.

This means that any input (apart from a sensor which must always report fire) can be allotted a set of attributes, which define how the control panel will respond when the input is activated.

As can be seen from the screen capture of the PC configuration programme below, there are many attributes to choose from for each input.

The key to the flexibility of the Syncro system is the ability to vary these attributes for each input.

Inputs (other than automatic sensors) need not simply report a fire or fault but can be used to signal all manner of other conditions and to control the system in many different ways.

Probably the most useful of these attributes is the INPUT ACTION and the following describes how the control panel will respond to each of these.

As mentioned previously, because this is fundamentally a fire system, automatic sensors cannot have their action attributes changed

For sensors the attributes, which may be altered, are as follows:

ADDRESS(1-127)

ZONE (0-500)

LOCATION TEXT (Up to 40 characters)

DAY SENSITIVITY

NIGHT SENSITIVITY

INDICATE PRE-ALARM
LOOP SOUNDER FITTED AS DETECTOR BASE
INPUT DELAY
OUTPUT DELAY BYPASS

For all other types of input however, there is an input action attribute, which empowers the system with control possibilities way beyond that of a normal fire alarm. Care must be taken to ensure that the system complies to the requirements of EN54-2 and local fire regulation requirements when these inputs are configured with delays or different input actions.

The following describes how the control panel will respond to each of these input actions.

18.2.1. Fire action

Being a fire control panel, the fire action will probably be the most widely used and a fire input will be announced by the following:

COMMON FIRE LEDS
ZONAL FIRE LED (IF USED)
PULSING BUZZER
SOUNDERS
ALARM CONTACT
FIRE CONTACT
FIRE ROUTING OUTPUT
LCD FIRE MESSAGE, ADDRESS AND LOCATION TEXT OF INPUT

18.2.2. Fault action

Inputs attributed the fault action will be announced by the control panel as follows:

GENERAL FAULT LED
CONTINUOUS BUZZER
FAULT CONTACT
MONITORED AUXILIARY OUTPUT
LCD FAULT MESSAGE, ADDRESS AND LOCATION TEXT OF INPUT

18.2.3. Pre-alarm action

Sensors or inputs can generate a pre-alarm. The control panel will respond as follows to a pre-alarm:

PRE-ALARM LED
CONTINUOUS BUZZER
LCD PRE-ALARM MESSAGE, ADDRESS AND LOCATION TEXT OF INPUT

18.2.4. Tech. alarm action (Technical alarm)

To allow a message to appear at the panel without necessarily performing any actions, technical alarm input is available which produces the following response by the panel:

CONTINUOUS BUZZER
LCD TECHNICAL ALARM MESSAGE, ADDRESS AND LOCATION TEXT OF INPUT

18.2.5. Evacuate action

The evacuate action allows all sounder outputs and sounders to be operated continuously from an input anywhere on the system with the following response at the panel:

COMMON FIRE LED's
CONTINUOUS BUZZER
PANEL SOUNDER OUTPUTS CONTINUOUS
LCD EVACUATE MESSAGE, ADDRESS AND LOCATION TEXT OF INPUT

18.2.6. Alert action

The alert action allows all sounder outputs and sounders to be operated in a pulsing mode from an input anywhere on the system with the following response at the panel:

CONTINUOUS BUZZER
PANEL SOUNDER OUTPUTS PULSING
LCD FIRE ALERT MESSAGE, ADDRESS AND LOCATION TEXT OF INPUT

18.2.7. Security action

The security action allows appropriately configured Hochiki CHQ-BS sounders to sound the selected Security tone from an input anywhere on the system with the following response at the panel:

LCD SECURITY ALERT MESSAGE, ADDRESS AND LOCATION TEXT OF INPUT

An input programmed as Silence displays an event message on the panel for the duration of the input being activated. The event is also stored in the event log.

18.2.9. Reset action

An input designated as reset will not produce any visible effect at the control panel but will reproduce the action of the reset button on the panel i.e. reset the alarms.
LCD RESET MESSAGE

18.2.10. Transparent action

A transparent input will have no effect at all on the panel. The only result of a transparent input is to control outputs via cause and effects configuration

18.2.11. Disablement action

Disablement inputs are used to disable a part or parts of the system via cause and effects configuration (normally for testing purposes).

When an input designated as a disablement is operated, the panel will display the following:

GENERAL DISABLEMENT INDICATOR
CONTINUOUS BUZZER
ADDRESS (1-126)
ZONE (0-500)
LCD DISABLEMENT MESSAGE, ADDRESS AND LOCATION TEXT OF INPUT

18.2.12. Test mode action

Inputs given the test mode attribute activate a special type of cause and effect which enables the system to be tested without activating selected parts of the system (plant shutdown relays for instance).

When a test mode input is operated, the panel will respond as follows:

ON TEST LED
LCD ON TEST MESSAGE, ADDRESS AND LOCATION TEXT OF INPUT

18.3. Outputs

Control of outputs uses the same philosophy as that described for inputs, i.e. all outputs are treated the same, whether they are loop controlled relays, loop sounders, sounder controllers, panel sounder outputs, panel programmable relays, remote I/O board outputs or the panel mounted programmable LED indicators.

Any output can be given a set of attributes, which defines, how the output will respond to input conditions.

Although this may appear to be nonsense in some cases, (a loop controlled sounder which doesn't operate upon a fire condition in its own zone for instance), this approach does provide a simplicity of understanding and a versatility and flexibility which would not exist if there were a different set of rules for each output.

There are default attributes for all types of output, which are factory set and will not change unless re-configured. This ensures that panel sounder outputs, bell controllers and loop sounders for instance, will respond to fire conditions unless the configuration for these outputs is deliberately changed.

NOTE – When configuring system outputs, care should be taken to ensure that the output operation conforms to the local fire regulation requirements.

The editable attributes are as shown below in this screen capture from the PC configuration programme.

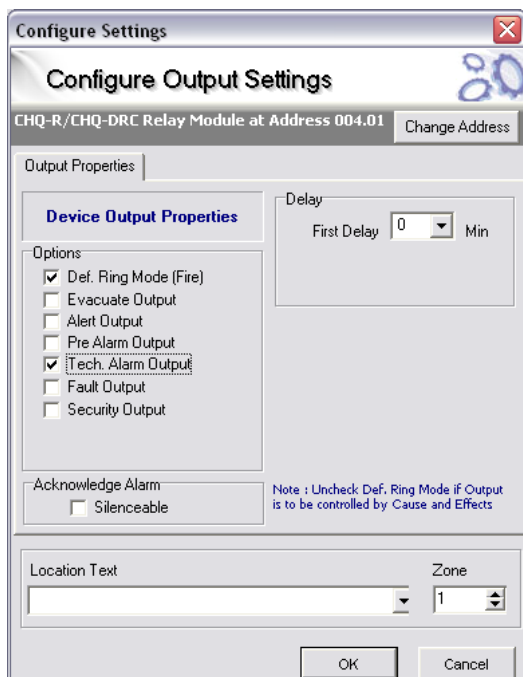

The following describes how each of these attributes affects the operation of the output.

18.3.1. Evacuate Output

An evacuate output will turn on continuously when any evacuate input is operated. This normally applies to sounders and would normally be accompanied by the Def. Ring Mode and Silenceable attributes.

Note: Any output on the Syncro system is considered as a sounder if the Silenceable and Evacuate Output attributes are selected. If any of these outputs are faulty or disabled, the sounder fault/disabled indicator will illuminate. These outputs would also be disabled by the 'Disable all sounders' menu option.

18.3.2. Def Ring Mode.

Normally applicable to sounders, Def. Ring Mode will turn the output on, upon a fire condition as defined by the global default ring mode set on the Panel Settings page of the PC configuration programme or as set via the Edit Configuration menus on the panel.

There are three options for Def. Ring Mode:-

Common Alarm - All outputs operate continuously regardless of which zone they are in.

Zoned Alarm - Outputs in the same zone as the input, which caused the alarm, will operate continuously.

2 Stage Alarm - Outputs that are in the same zone as the input which caused the alarm will operate continuously whilst outputs in all other zones will pulse 1 second on - 1 second off.

The factory default setting for the panel Default Ring Mode is Common Alarm.

This normally applies to sounders and would normally be accompanied by the Evacuate and Silenceable attributes.

By default, after the alarm device outputs have been silenced, activation of another device in another zone will re-sound the fire alarm device outputs.

It is possible to configure the system such that following silencing of the alarm device outputs, activation of another device in another zone will not re-sound the alarm device outputs.

This is selected at access level 3 via the EDIT DEFAULT RING MODE MENU and selecting RESOUND ON SECOND FIRE IN ANOTHER ZONE and then Coincidence Resound Mode Off.

18.3.3. Silenceable

Silenceable is normally applicable to sounder outputs and ensures that the output switches off when the alarm is silenced / acknowledged by the front panel pushbutton or operation of an input that is configured as silence alarm.

Note: Any output on the Syncro system is considered as a sounder if the Silenceable and Evacuate Output attributes are selected. If any of these outputs are faulty or disabled, the sounder fault/disabled indicator will illuminate. These outputs would also be disabled by the 'Disable All Sounders' menu option.

18.3.4. Alert

An alert output will pulse on and off when any alert input is operated. This normally applies to sounders and would normally be accompanied by the Def. Ring Mode and Silenceable attributes

18.3.5. Stage one delay

Outputs can be delayed from 0 to 5 minutes in half-minute steps by changing the default delay of zero to the desired setting.

18.3.6. Stage two delay

If the output is silenceable, the stage two-delay option becomes available. The stage two delay gives an additional time before the output operates after the alarm is acknowledged during the stage one delay.

Note: Care must be taken when configuring outputs with a combination of delays to some outputs and no-delays to other outputs. To start the Stage two delay, the Silence Alarm / Acknowledge button must be pressed during the Stage one delay period. If outputs elsewhere on the system are configured with no output delays and are also configured as silenceable, then these outputs will be silenced when the stage one delay is acknowledged.

In the majority of systems, the delays to outputs are configured to all sounder outputs to allow a variable search time and therefore this comment is not applicable.

18.3.7. Zoning

Each output can also be put into a zone or not as required. It is useful to put outputs into zones if the output is required to respond to default ring mode or is to be controlled by a cause and effect entry.

Outputs that are not put into a zone and are configured to respond to default ring mode will always turn on with any fire condition (i.e. common alarm).

18.3.8. Location text

Finally, each output can be given a location address. As well as being useful in identifying devices with monitored outputs and additional power, for fault conditions, the location address can be useful in identifying the device when compiling cause and effects programmes.

18.3.9. Tech alarm

A Tech alarm output will turn on continuously when any Tech alarm input is operated.

18.3.10. Pre-alarm

A pre-alarm output will turn on continuously when any pre-alarm input is operated.

19. Cause and effect programming

For more complex applications, it is often a requirement to control plant, ventilation or access control systems in the event of fire situations to assist with evacuation or to provide safety escape routes.

Because the Syncro system has inherent flexibility, this is simple to achieve by applying cause and effects to inputs and outputs anywhere on the system.

Cause and effects can be started or acted upon by any part of the system not just the detection loop or control panel but by both of these and by the additional I/O modules too.

It is also network wide. Any part of the system can contribute to a cause and effect action and similarly any output can be operated by an input or any combination of inputs.

With careful planning, this can save costs on installation by reduced wiring runs and can be changed at any time to suit changes in requirements.

Cause and effect programming requires the Loop Explorer software (which will run on a Windows ® 95 compatible computer) and a download lead to transfer the data to the control panels.

Using cause and effect programming it is possible to combine inputs or zones using logical operators, to operate on outputs in any manner desired.

It should be noted here however that when using zonal cause and effects the system will act upon fire inputs in the zone of activation only. Inputs in the selected zone that are not configured as fire event type will not contribute to a zonal cause and effect.

Cause and effects can also be used to disable any outputs or groups of outputs in response to the chosen input conditions. This is particularly useful where normal operation of the fire system requires regular intervention by the end user as switches can be provided anywhere on the system to allow isolations to be performed without operating the control panel.

Also to assist the end user and encourage regular testing, a special "Test Mode" cause and effect facility is included which allows specific parts of the system to be tested without operating sounders or shutting down plant etc. This would normally have to be done by disabling individual outputs at the control panel with the risk of missing something and shutting down an important plant or process.

Full details of cause and effect programming are included with the Loop Explorer software, which also allows full system configurations to be created and downloaded to individual or an entire network of control panels using a simple graphical user interface.

The Loop Explorer programme contains comprehensive, context sensitive help files and example applications.

NOTE – When configuring the system using cause and effects, care should be taken to ensure that the system operation conforms to the local fire regulation requirements.

20. Optional printer

All control panels are available with or without a printer and fixings are provided on all panels so that a printer may be fitted at a later date, if required. Installation instructions are supplied with the printer.

The printer is a front loading thermal type and requires 58mm wide heat sensitive paper rolls, which are easily loaded by lifting the latch on the printer to gain access to the paper chamber. The new roll must be loaded with the paper exiting from the top of the paper chamber and with the shiny side facing the top of the panel.



Lift the tinted latch to open. The new roll must be loaded with the paper exiting from the top of the paper chamber and with the shiny side facing the top of the panel.

Power Save & Printer Fault

To reduce standby power consumption, the printer is only powered when it has something to print. To feed the paper, press the panel reset button. The paper will be fed into the printer as it prints this event.

When the paper has run out, the printer will report a printer fault message on the Syncro panel.

On panels with V4.4 or V5.3 (Kitemarked panels) or later firmware, the printer power save and printer fault is switched off by default. The printer power save is then only activated when the mains fail and charger fault events are active (to reduce standby battery drain).

Selecting the "Graphics Fitted" option in the panel settings in Loop Explorer will restore the general power save and printer fault reporting features.

21. Networking

It is possible to connect control panels such that information can be shared between them and for control panels to operate outputs on other control panels in response to alarm conditions or cause and effects configurations.

To do this, each panel must be fitted with a networking board, which plugs onto the main display board into connectors J1 and J3.

To fit a networking board, the panel must have both its mains and battery power removed. The metal cover over the display PCB must then be removed by loosening the retaining screws and lifting it off.

Remove the screws and washers from the two fixing pillars in located in the network boards fitted position.

Locate the network board over connectors J1 and J3 and push the board firmly into place until it is fully located in the connectors. Fit the screw and washer through the two holes in the network board and into the fixing pillars to hold the board in place.

The cover should then be replaced and held in position with the retaining screws that were removed.

Each control panel has two pairs of terminals on the terminal board for connection of the network cable in and out. It is recommended that a cable such as Belden 9841 suitable for transmission of EIA RS-485 data be used.

The network connection must come into each panel on the "Network In" terminals and go to the next panel on the "Network Out" terminals, returning to the first panel "In" from the last panel "Out" terminals.

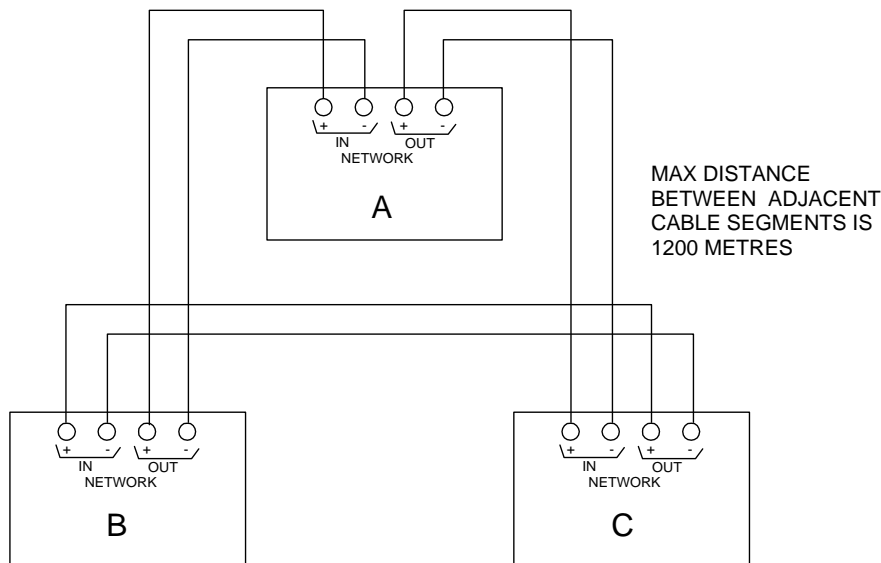

Network boards are fitted with isolators, which disconnect faulty sections of cable and allow the network to continue working by using the return path so it is most important that this wiring configuration be adhered to.

A more detailed description of networking capabilities can be found in the Syncro Networking Manual.

22. Modem

The Syncro fire alarm system modem communications module, allows the fire alarm control panel to be interrogated from a remote location via a dial up telephone connection. This allows the status of the control panel to be viewed and the configuration data and event log to be uploaded to a PC.

To enable modem configuration and connection, the user **must** be in possession of registered and dongle protected Loop Explorer Version 3 (or later) software. The Syncro display PCB must be Issue 6 or later to support the modem hardware and will need to be loaded with panel operating system Version 3 or higher.

The modem fits in the space between the power supply and the loop driver board and requires a 24V DC supply which can be taken from the adjacent AUX 24V connections. When retrofitting a modem a kit is supplied which contains all necessary cables and instructions.

A telephone connection socket (type RJ45) is fitted at the top of the module to allow connection to an RJ11 telephone point using the connection cable supplied.

For detailed information on the modem, see the Syncro Modem Communications Module manual.

23. Panel Settings

23.1. Contrast Adjust

The viewing angle / contrast of the Syncro front panel display may be adjusted by turning the "DISPLAY CONTRAST ADJUST" potentiometer on the display PCB. On older control panels, it will be necessary to remove the display PCB cover in order to gain access to this potentiometer. The location of this potentiometer in relation to the PCB is shown in Appendix B.

WARNING: Under no circumstances should any adjustments be made to potentiometer VR2 in the top left location of the display PCB.

23.2. Network address setting

If there is more than one panel on the system, or the panel is communicating with a repeater panel, then a network card will need to be installed within each panel in the network. Each panel will need to be allocated a separate network address identification. This is performed by use of a binary coded DIP switch on the network card.

Access to this switch is provided via an aperture on the display PCB cover. A sample address setting is also shown on the cover, for guidance purposes. On older control panels it will be necessary to remove the display PCB cover to gain access to this network address switch.

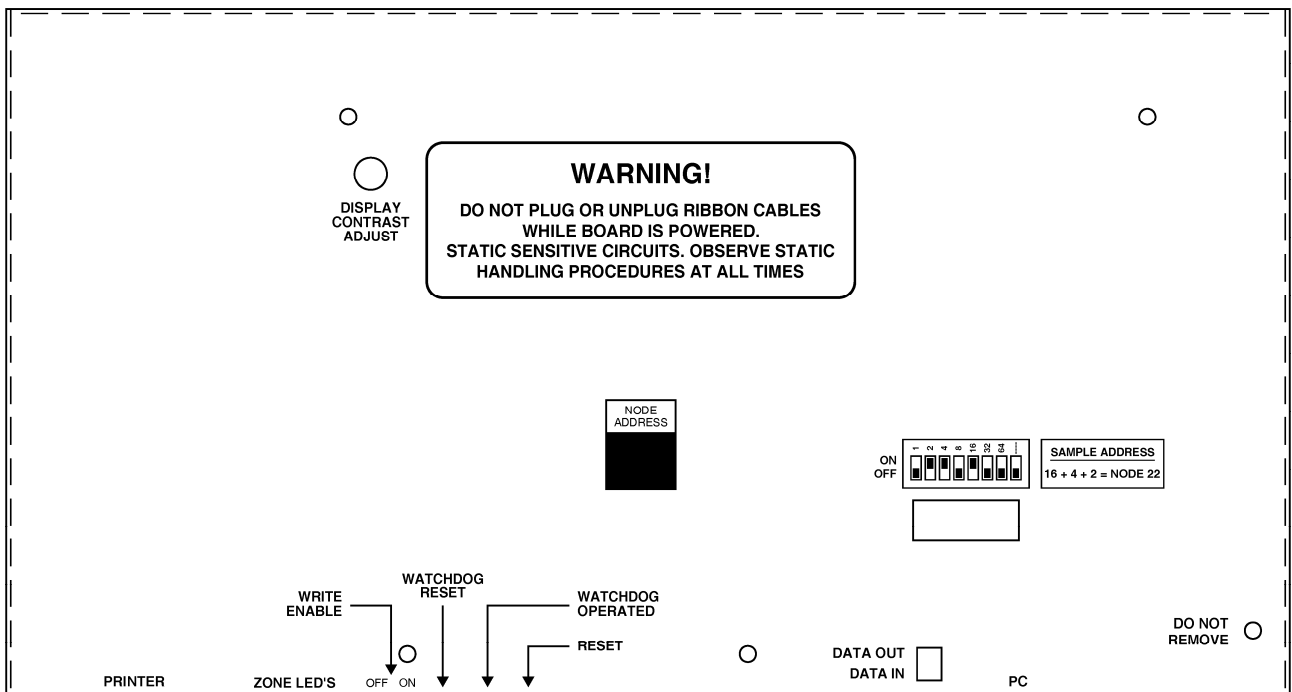

24. Panel specification summary

24.1. Recommended cables

All field wiring should be installed using fire rated cables such as FP200, MICC or Fire Tuff types. The minimum cross sectional area should be 1mm although in the case of the detection loops this depends upon the length of the cable and the number and type of devices fitted. Loop length calculators for various cable types are available for both Hochiki and Apollo protocol systems. Drain wires of any field wiring should be maintained throughout the length of the cable and terminated at the panel earth block, via brass cable glands. Refer to [Section 4.1](#) for Apollo loop earth termination requirements.

24.2. Sounder Load

Panel Sounder - Four 24 volt sounder circuits, each fused with a 1.0A self-resetting electronic fuse. Each sounder circuit is monitored using reverse polarity and a 10k ohm end of line resistor.

Loop sounders – each loop is capable of delivering up to 400mA for devices and loop sounders & beacons.

The total monitored output load (loop & panel sounders, fire routing, extinguishing & aux 24V output) must not exceed 2 Amps.

24.3. Current consumption

2 loop panel current consumption	255mA (power fault) 540mA in alarm (no alarm load)
4 loop panel current consumption	355mA (power fault) 650mA in alarm (no alarm load)
S560 I/O board current consumption	20mA (quiescent), 100mA per output
Modem current consumption	50mA
Network card current consumption	80mA
8 way relay card current consumption	10mA (quiescent), 250mA in full alarm
6 way sounder card current consumption	30mA (quiescent), 260mA in full alarm + sounder load

24.4. Power supply –

Part reference	S406 EN54-4, 4Amp switch mode power supply
Supply Voltage	230V AC nominal (+10% / 15%)
Supply rating	4A
Battery Charger	Charges up to 15Ah sealed lead acid batteries with temperature compensation over the range -5 to +40 degrees Celsius.
Battery Type (Yuasa NP)	Two 12V sealed lead acid 12Ah maximum
Battery charge current	1.25A nominal.
Battery low indication	21V
Battery disconnect	19V
Battery impedance fault	More than 1 ohm in series with battery
Earth fault indication	< 30Kohms +28V or 0V to earth.

24.5. Field devices

Hochiki	127 devices per loop- ESP protocol
Apollo	126 devices per loop - S90, XP95, XPlover and Discovery ranges.
Argus Vega	240 devices per loop
Per 2 loop panel	254 Hochiki ESP devices, 252 Apollo devices, 480 Argus Vega devices
Per 4 loop panel	508 Hochiki ESP devices, 504 Apollo devices, 800 Argus Vega devices
Sub-address total	800 addresses and sub-address limit per panel.

NOTE – To meet the requirements of clause 13.7 of EN54-2, the total number of detection devices and call points (including any conventional devices fitted to zone monitors) must not exceed 512 devices.

24.6 Fire / Alarm / Fault / Relay 1 and Relay 2 ratings (see also Section 13)

All panel relay contacts are rated at 30V DC and 1 Amp maximum.

Under no circumstances should voltages or currents outside of these limits be connected.

24.7 Zones

Panels are available with 0,16, 48 or 96 zone LED indicators fitted. Any device can be configured to any one of 500 zones available across all panels on the network.

Care should be taken to ensure that no more than 32 devices should be affected by a single short or break in any detection circuit.

24.8 Networking

Up to 64 control panels can be connected together using an RS485 type cable with a maximum distance (without boosters) of 1.2Km between adjacent cable segments. An additional network PCB is required in each panel to achieve this.

Repeaters (full functional and display only) each take a single address from the 64 available network addresses.

Refer to Networking Manual

24.9 Fire Routing and Auxiliary monitored outputs (see also Section 14)

Fire Routing - 24 volt output operating whenever the panel is in a fire condition, protected by a 500mA self-resetting electronic fuse. Monitored using reverse polarity and a 10k ohm end of line resistor.

Monitored Auxiliary Output - 24 volt output operating whenever the panel is in a fault condition (by default), protected by a 500mA self-resetting electronic fuse. Monitored using reverse polarity and a 10k ohm end of line resistor. Can be re-programmed to any other output response.

24.10 Extinguishing monitored output (see also Section 15)

24 volt output operating only when configured using the panel configuration software, protected by a 1.1A self-resetting electronic fuse. Monitored using reverse polarity and a 1N4004 end of line diode.

24.11 Remote Control Inputs (see also Section 16)

Unmonitored digital inputs, activated when connected to the Remote Control 0V terminal with an in line resistance of less than 50 ohms.

Note: Remote control inputs must be restricted by the Access level requirements of EN54-2. Therefore it should not be possible to remotely reset, silence or operate the alarm devices without some means of gaining access to this function.

24.12 Auxiliary 24 Volt monitored output (see also Section 18.1)

Permanent 24 volt output protected by a 500mA self-resetting electronic fuse, monitored for fuse failure.

24.13 Fuse ratings

All panel power supplies, monitored outputs and auxiliary power outputs are protected by non-serviceable self resetting electronic fuses.

Detection circuits are protected using digital current monitoring circuits and FET switching techniques.

The Syncro panel has only one serviceable fuse to protect the incoming mains supply. This fuse is a 3.0 Amp (250V HRC) 20mm type and must be replaced with a fuse of the same type only.

25. Additional Features

25.1. Loop Data Test

The data signalling between the control panel and detection devices has some level of data error checking built into the protocol. The purpose of this data checking is to ensure that any spurious signals received by the control panel are not incorrectly interpreted as fire signals, thus avoiding an unwanted activation. Information received at the control panel that is not exactly as it is expected to be is known as bad data.

There are a number of sources of signalling errors. The most common is due to electrical interference resulting in current spikes induced on the detection circuit. Other possible causes are poor loop wiring connections, earth leakage between loops, cross-talk between circuits, defective devices installed on the detection circuit and incorrect devices connected on the detection circuit. Excessive loop resistance is the cause of many bad data faults. These tend to be from devices located nearest the Loop In terminals. If loop resistance is suspected, swap the loop in and loop out cables and see if the bad data faults start occurring from devices fitted at the other end of the loop. Also excessive Loop Sounder Current will cause bad data faults to occur when the sounders are operated

In general, the user is unaware of problems on the detection circuit, as the panel has some "software filtering" built in, to reject invalid data returned from devices. However, if a single device returns invalid data on four consecutive polls, the panel will report a bad data fault for that device. If a single device returns invalid data for three polls, followed by a single good poll, then the panel will report no faults for that device.

The purpose of the system diagnostics facility is to see what level of invalid data signalling is occurring on the loops, to get a "feel" for the quality of the signalling and to predict any potential problems that may affect the end user.

The diagnostics facility comprises of two counters for each loop. These counters have a maximum value of 9,999,999. There is a "good" counter, which is incremented for every successful detection device poll and a "bad" counter, which is incremented every time there is an error in the signalling when a device is polled.

This good/bad counter selection allows an engineer to see the proportion of bad readings versus good readings, and compare these between loops for a system. From this information, it should be possible to make a judgement on the signalling quality for each detection circuit on any control panel.

To activate the diagnostics, select the Loop Data Test menu option at Access Level 3. This menu will then allow the user to start the testing for each loop in turn. When started, the user may view the good and bad counters, plus the time that the test was started.

At any time it is possible to view the counters or cancel the testing.

When either of the two counters reaches the maximum value, the test for that loop is halted.

25.2. Network Panel Menu Control

When Syncro AS control panels are connected as a network, it is possible to perform Access 2 Menu commands on remote panels from any panel on the network. This facility is executed by use of an interim "select panel" menu option whenever the Syncro is installed on a networked system.

25.2.1. Network Disablements

On a networked system, select the access 2 menu from any control panel. Move the selection cursor to be next to the Disablements menu option. Press the right arrow navigation key to choose the menu selection.

At this point you will be asked to select which panel you wish to select disablements for. The default panel will be the local panel. Use the up / down arrow navigation keys to scroll through available panels, then press the right arrow navigation key to choose the selected panel.

At this point, the standard disablement menu options will be viewed. **These menu options apply to the selected panel, rather than the local panel.**

When selecting disablements, all options are the same as for a standard panel.

25.2.2. View Device Details on other panels

It is possible to view device details for devices connected on remote panels from any panel on a networked system using the View Devices menu option in the Access 2 menu.

Note: When viewing device details on a remote panel, the scrolling and refresh rate will be slower than for devices on a local panel.

25.2.3. Global System Time

Whenever the system time is set on any panel on the networked system, then all panels will be set to this time. This simplifies the process of changing the time for daylight saving on large networked systems.

25.3. Configuration Transfer over Network

Using Loop Explorer Version 3 or later, it is possible to transfer the configuration to any panel or all panels on the network from a single place. This eliminates the need to go to each control panel in turn to transfer updated configuration files. The write enable switch must be switched on at the target panel before it is possible to transfer a configuration file across the network.

25.4. Contamination Status

The Syncro control panel calibrates all detection devices every 24 hours, at a time specified by the panel configuration settings.

The calibration procedure checks a number of parameters for each device to ensure that the device will meet the performance specification, as defined by the device manufacturer. If any devices fail to meet this calibration procedure, then the device will be announced as a calibration fault and will need to be replaced.

When devices exceed 85% of their calibration fault limits, they are added to the "Contamination Status" log. At this point, the control panel will not report a fault for the device.

The Contamination Status menu option allows the maintenance engineer to view these devices, to replace them and therefore prevent contamination faults between service calls.

This menu option is available across panels on a networked system, allowing the contamination status for any panel to be viewed from any panel.

25.5. Analogue value transfer

If a connection to the Syncro AS panel is made using the "Connect" screen of Loop Explorer Version 3 (or later), it is possible to transfer the analogue levels, zero calibration and fire calibrations points for each detection device to the PC.

Using Loop Explorer, it is possible to save this information into a Comma Separated Values (csv) file format for later analysis.

Appendix A – EN54 Configuration Requirements

In order to meet the requirements of EN54, the panel must be configured with the settings stated below.

References refer to EN54 Part 2 1997 clause numbers.

Section 7 – Fire Alarm Condition

Section 7.1.4

Input delay must be set to zero for all manual call points. Call points must not be configured to any event type other than Fire.

Section 7.2.c / 7.4 / 8.2.1.c / 8.6

The panel buzzer must be enabled. The system disablements menu option must not be used.

Section 7.6.1

The internal “Reset” remote control input must be configured so that it is only available at Access level 2, by use of a key input or some other access restriction.

Section 7.8

If the panel sounder circuits are to be used to meet the requirement of “transmission of fire alarm signals to fire alarm devices”, then the Def Ring, Silence and Evacuate properties must be selected. The sounder circuits must also be mapped to Zone 0.

Section 7.9

The fire routing output must be set to Zone 0 and to respond to Def Ring mode only.

Section 7.11

Care must be taken when configuring outputs with a combination of delays to some outputs and no-delays to other outputs.

To start the Stage two delay, the Silence Alarm / Acknowledge button must be pressed during the Stage one delay period. If outputs elsewhere on the system are configured with no output delays and are also configured as silenceable, then these outputs will be silenced when the stage one delay is acknowledged.

Section 7.11.a

To select delays to outputs at access level 3, use the Edit Configuration / Edit Panel I/O / Panel Outputs to select the sounder outputs or fire routing output. Select the output and configure the 1st stage delay to the required amount.

Section 7.11.d

All call points must be configured with the “Bypass delay” attribute set.

Section 7.12.3 – Type C Dependency Programming

In order to meet the EN54-2 requirements for Type C Dependency Programming, the following cause and effects is required to configure a particular zone for Type C Dependency.

- The cause and effect has all detection devices and/or call points in the required zone selected (by address) and the ‘COINCIDENCE’ logical operator used to switch the required outputs in the effect screen.
- An alternative to the above is to use a cause and effect with the zone selected and with the “coincidence by zone – any two in zone” logical operator. The option to “exclude call points” is provided.
- All outputs controlled by the above cause and effect must have the Def Ring output flag deselected to ensure compliance

Section 8 – Fault Warning Condition

Section 8.2.4.c

Earth fault monitoring must be enabled. The system disablements menu option must not be used.

Section 8.8

The fault relay output must be configured to respond only to fault events.

Section 8.9

The monitored auxiliary output does not meet the requirements of the fault routing output when configured only to respond to fault events. This is because it does not give an output signal of fault when the panel is de-energized.

Section 9 – Disabled Condition

Section 9.1.2

If a disablement input type is used as the cause a disablement cause and effect, this input must be configured so that it is only available at Access level 2, by use of a key input or some other access restriction.

Section 9.1.4

If a disablement input is used as a cause for a disablement cause and effect, this input must be configured to be non-latching and should not reset when the system reset is selected. It can only be cleared by a manual action at access level 2.

Section 10 – Test Condition

Section 10.1.b

If a test input type is used as the cause in a test mode cause and effect, this input must be configured so that it is only available at Access level 2, by use of a key input or some other access restriction. This input must be configured as non-latching and can only be cleared by a manual operation at access level 2.

Section 12.5 – Integrity of Transmission Paths

Section 12.5.2

A short circuit isolator must be fitted to the detection circuit at a maximum interval of 32 detection devices and manual call points.

Section 12.6 – Accessibility of indications and controls

Section 12.6.6

The panel door must be locked and the key removed.

Section 12.9 – Colours of indications

Section 12.9.1.a

If the Aux LEDs are used to show indication of fire alarm events, then they shall be configured to Red colour.

Section 12.9.1.b

If the Aux LEDs are used to show indication of fault events, then they shall be configured to Yellow colour.

Appendix B - Internal controls

DISPLAY
CONTRAST ADJUST

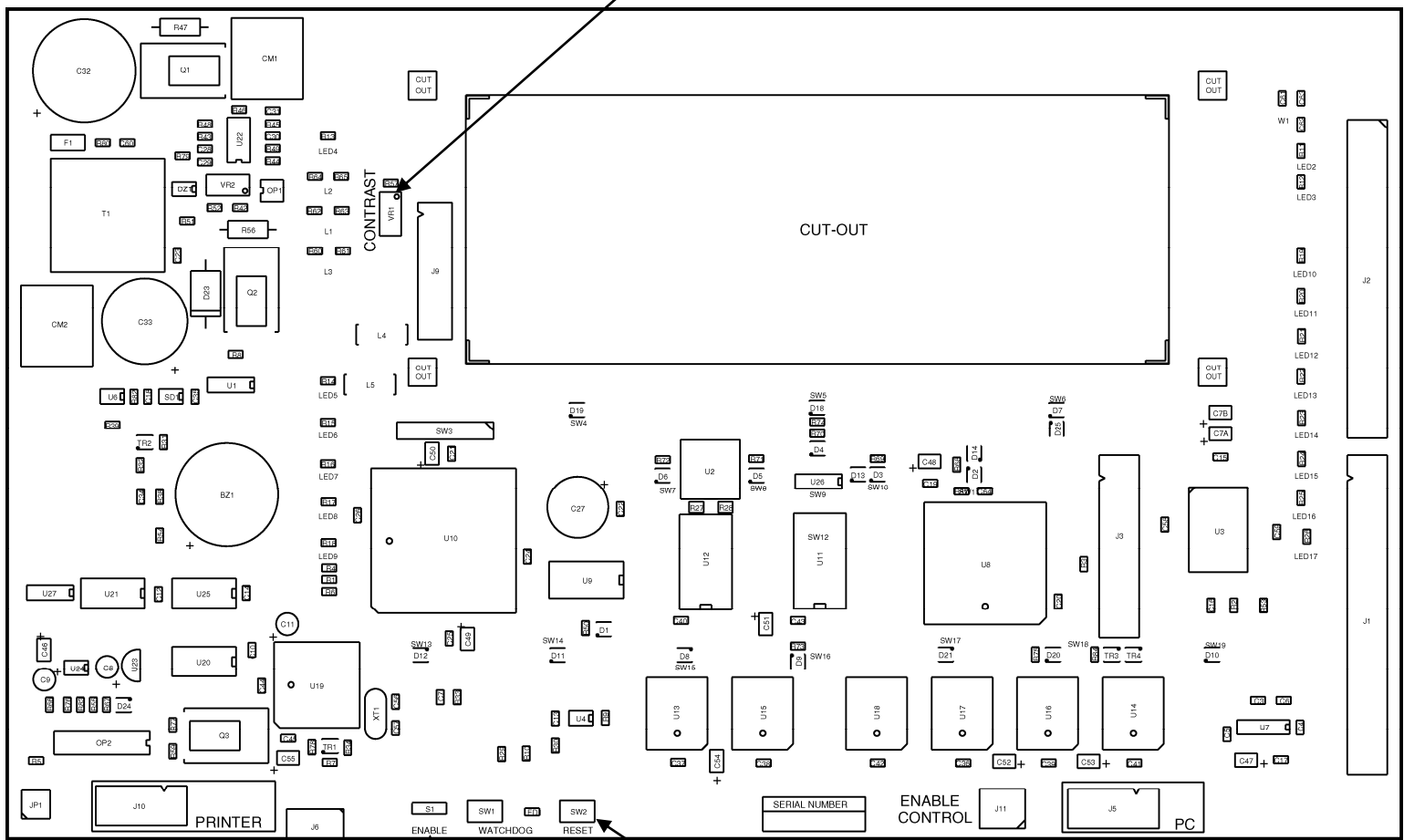

To Loop PCB

Network Connector

Printer connector

Zone LEDs

Write Enable

Watchdog reset

Main processor reset

Connection to pc

Appendix C - System Schematic Diagram

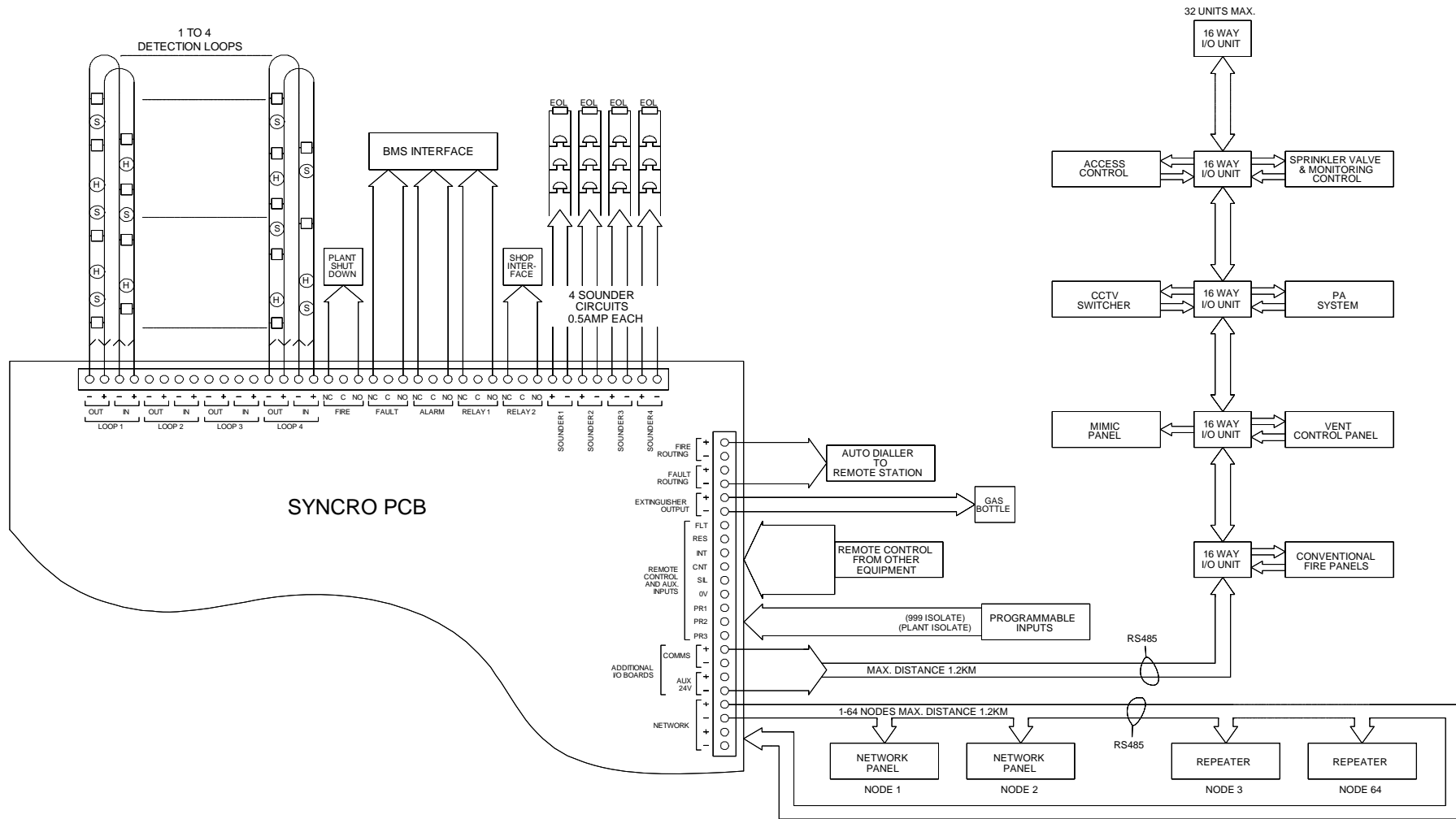

Appendix D – Specifications

Overall size	500mm x 355mm x 110mm or 500mm x 405mm x 175mm
Finish	BS 00 A 05 mid grey fine texture
Mains supply	230V AC, 50Hz +10% -15%
Mains supply fuse	3.0 Amp (250V HRC)
Power supply rating I _{max a}	1A
Power supply rating I _{max b}	5 Amps
Operating voltage	18 to 30 volts DC
Battery charging circuit impedance R _{imax}	0.7R
Minimum output current for correct operation	I _{min} 130 milliamps
Maximum ripple current	1.5+/- 0.3 Volts
Battery type	Yuasa NP 12Ah – 17Ah
Battery charge voltage	27.6V DC nominal (temperature compensated)
Battery charge current	1.25A max
Maximum current draw from batteries	7 Amps
Aux 24V output rating	300 milliamps maximum load (fused at 500 milliamps)
Sounder output rating (four outputs)	Each rated at 1A
Relay contacts	30V DC, 1 Amp maximum
Detection loop current	400 milliamps maximum