

FCX-100-101	Optical Smoke Detector & Remote Indicator Unit	[2][3]
FCX-120-101	Heat A1R Detector c/w Remote Indicator Unit	[1][3]
FCX-120-111	Heat CS Detector c/w Remote Indicator Unit	[1][3]
FCX-170-101	Wireless Detector Base c/w Remote Indicator Unit	[3]
5-RIM	Remote Indicator Unit Only	[3]

See the Specification section for compliance information.

## Wireless Detector c/w Remote Indicator Installation Guide

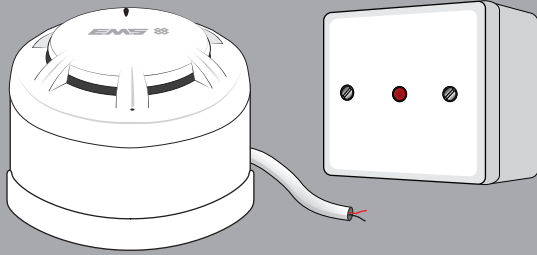

Example shown:  
Model FCX-100-101

### 1 Pre Installation



Installation must conform to applicable local installation codes and should only be installed by a fully trained competent person.

- Ensure that the device is installed as per the site survey.
- The use of a non-metallic spacer should be considered if mounting the device on to a metal surface.
- Do NOT Press the Log On button on a pre-programmed device. This will cause communication with the Control Panel to be lost. Should this happen, delete the device from the system and add it back on.

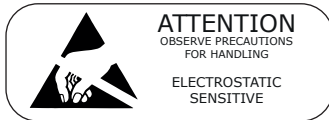

### 2 Components

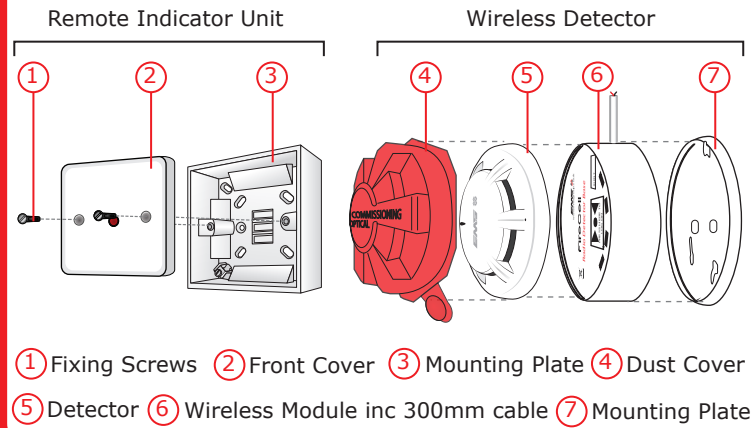

### 3 Fix Mounting Plate

Remove the mounting plate from the wireless module, by turning it anticlockwise.

- Use both mounting holes to ensure a firm fixing.
- Use suitable fasteners and fixings.

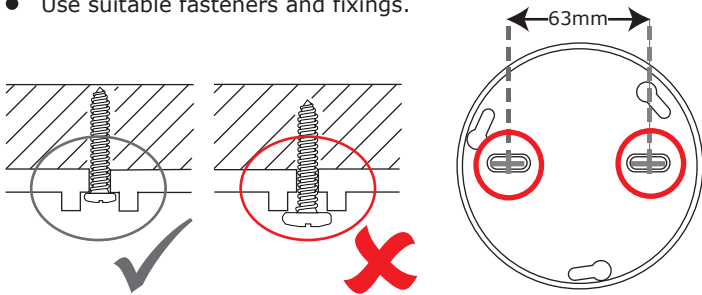

### 4 Power Device

- OBSERVE CORRECT POLARITY, USING SPECIFIED BATTERIES.
- If fitting / re-fitting batteries; observe correct polarity, using only specified batteries.
- Connect the power jumper across the PIN header.

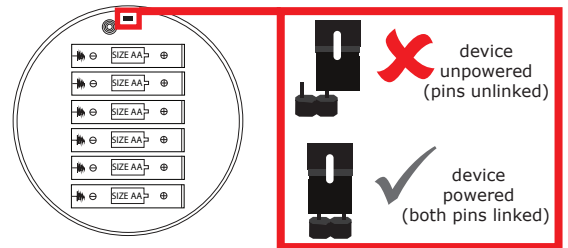

- Once powered, reassemble the device.

### 5 Optional Device Locking

- To lock the detector into the wireless module, insert a 1.5mm Allen key into the allen key slot and turn clockwise as shown.
- To unlock, insert a 1.5mm Allen key into the Allen key slot and turn anticlockwise as shown.

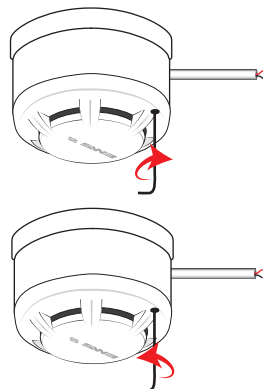

### 6 Configuration

The device's loop address is configured within the menu structure of the Radio Hub.

- Refer to the programming manual (Doc Ref: MK98) for full programming information.



Free to download from  
[www.emsgroup.co.uk](http://www.emsgroup.co.uk)

## 7 Remove Cable Entry Points

- Only use knockouts shown in shaded areas.

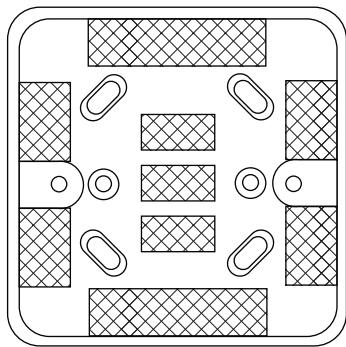

## 8 Fix to the Wall

- Use suitable fasteners and fixings.
- Use all four mounting holes.

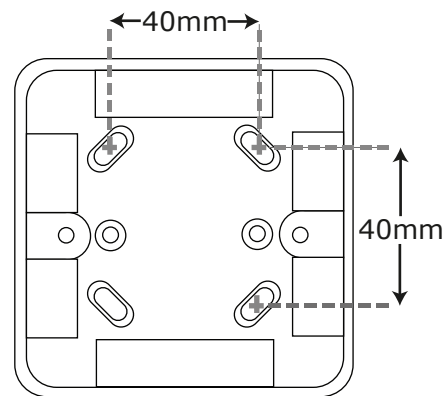

## 9 Wiring

- Connect using the two way + and - terminals, observing correct polarity.
- Pass the cable through the premade entry points.
- Cabling can be extended up to 30m if required, using a closed electrical connector.
- A maximum of one detector is to be fitted to the Remote Indicator

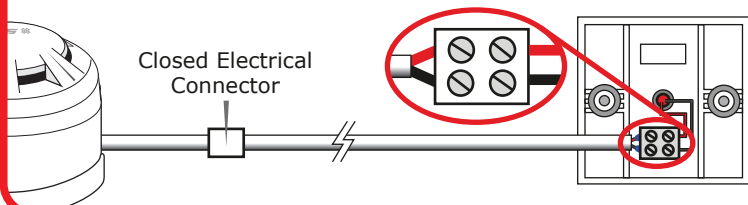

## IMPORTANT

- Remove dust cover before use.
- The device should be tested upon installation and in accordance with local requirements.
- Testing should only be carried out by a fully trained competent person.
- The Manufacturer recommends regular functional testing of at least once per annum or in accordance with local codes of practice.
- Cleaning and repairs must be undertaken by the Manufacturers authorised representative.
- Do not open the case to clean inside the detector.

## Specification

<b>Operating Temperature</b>	-10°C to 55°C
<b>Storage Temperature</b>	5°C to 30°C
<b>Humidity</b>	Up to 95% non-condensing
<b>Supply</b>	6x AA Alkaline (Panasonic LR6AD Powerline / Varta 4006 Industrial)
CAUTION! Fitting of an incorrect battery type invalidates the product certification and may result in poor performance.	
<b>IP Rating</b>	IP23
<b>Operating Frequency</b>	868MHz
<b>Output Transmitter Power</b>	Auto adjusting 0 - 14 dB (0 - 25 mW)
<b>Dimensions (mm)</b>	85(H) x 85(W) x 45(D) (Remote Indicator Unit) 113 (Ø) 81 (D) (Wireless Detector)
<b>Weight</b>	0.15kg (Remote Indicator Unit) 0.40kg (Wireless Detector)
<b>Location</b>	Type A: For indoor use

## Regulatory Information

<b>Manufacturer</b>	EMS Ltd. Technology House, Herne Bay, Kent, CT6 8JZ, United Kingdom
<b>Year of manufacture</b>	See devices serial number label
<b>Certification</b>	<b>CE 10</b>
<b>Certification body</b>	<b>0359</b>
<b>CPR Certificate DOP</b>	See part listing for associated products: [1]0359-CPR-0015, [2]0359-CPR-0017 & [3]0359-CPR-0041
<b>Approved to</b>	See part listing for associated products: EN54-5:2001. Incorporating Amendment No. 1. Fire detection and fire alarm systems. Part 5: Heat detectors - Point Detectors. [1] EN54-7:2001. Incorporating Amendment No. 1. Fire detection and fire alarm systems. Part 7: Smoke detectors - Point detectors using scattered light, transmitted light or ionization. [2] EN54-25:2008. Incorporating corrigenda September 2010 and March 2012. Fire detection and fire alarm systems. Part 25: Components using radio links. [3]
<b>European Union directives</b>	EMS declares that the radio equipment type FireCell Detector c/w Remote Indicator is in compliance with Directive 2014/53/EU. The full text of the EU declaration of conformity is available at the following internet address: <a href="http://www.emsgroup.co.uk">www.emsgroup.co.uk</a>



2012/19/EU (WEEE directive):  
Products marked with this symbol cannot be disposed of as unsorted municipal waste in the European Union. For proper recycling, return this product to your local supplier upon purchase of equivalent new equipment, or dispose of it at designated collection points. For more information see [www.recyclethis.info](http://www.recyclethis.info)  
Dispose of your batteries in an environmentally friendly manner according to your local regulations.