

Zone Interface Module Installation Guide

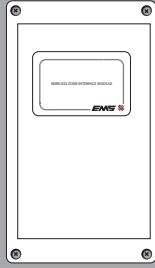

1 Pre Installation



Installation must conform to applicable local installation codes and should only be installed by a fully trained competent person.

- Ensure that the device is installed as per the site survey.
- The use of a non-metallic spacer should be considered if mounting the device on to a metal surface.
- Do NOT Press the Log On button on a pre-programmed device, as this will cause communication with the Control Panel to be lost. Should this happen, delete the device from the system and add it back on.

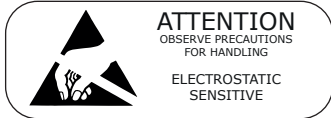

2 Components

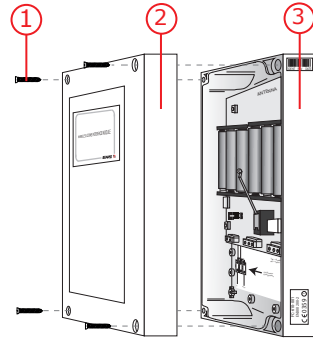

- ① 4x Lid Fixing Screws ② Front Lid ③ Back Box

3 Mounting Location Guidelines



For optimum wireless performance, the following must be observed:

- Ensure the ZIM is not installed within 0.6m of the WZM.
- Ensure the ZIM is not installed within 2m of the Control Panel or any other wireless or electrical equipment.
- Ensure the ZIM is not installed within 0.6m of any metal work.

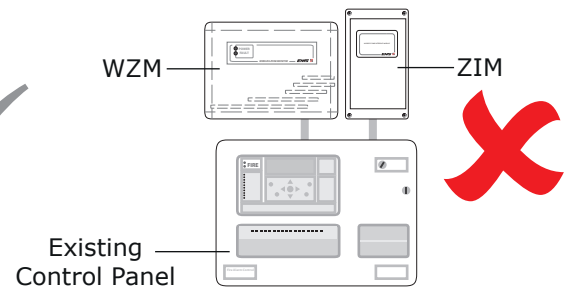
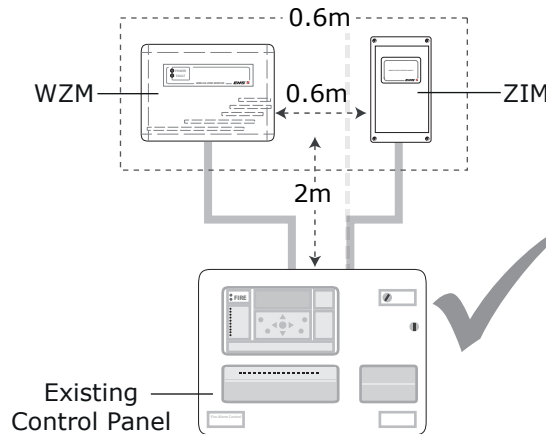

4 Remove Cable Entry Points

- Drill the cable entry points as necessary.
- Cable glands should be used.
- DO NOT leave excess cable in the device.

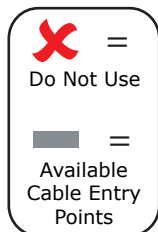
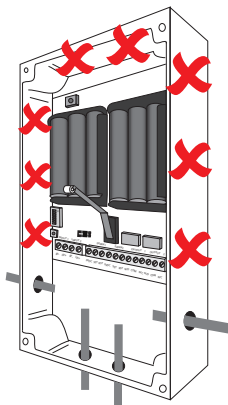

5 Fix to the Wall

- Use all four circled fixing positions to ensure a firm fixing.
- Use suitable fasteners and fixings.

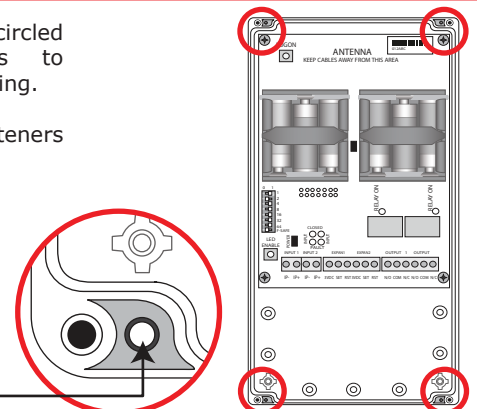

6 Connection Wiring

Refer to the Wireless Zone Monitor Engineers Guide (Doc Ref: TSD143) for full wiring details.

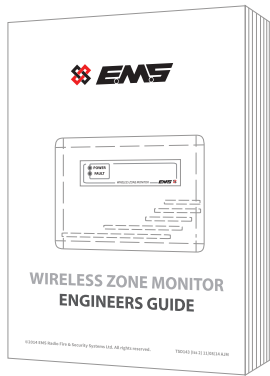

Free to download from www.emsgroup.co.uk

7 Power Device

- When fitting / replacing batteries; observe correct polarity, using only specified batteries.
- Connect the power jumper across the PIN header.

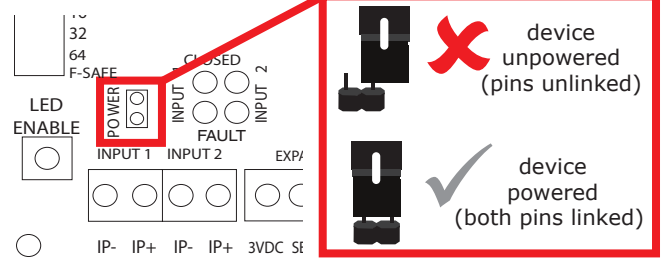

- Once powered, reassemble the device.

8 Configuration

The ZIM must be added to the WZM, before adding other wireless devices to the system.

- Refer to the Wireless Zone Monitor Engineers Guide (Doc Ref: TSD143) for full programming details.



Free to download from www.emsgroup.co.uk

9 LED Operation

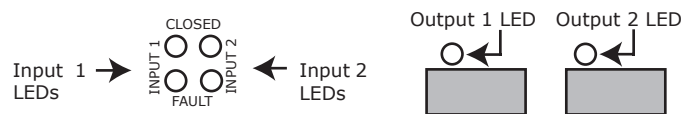

The device has six indication LEDs. Pressing the LED enable button enables their illumination for 10 minutes before automatically timing out.

2x Input Fault: YELLOW LED ON ☀️ = FAULT

2x Input Closed: RED LED ON ☀️ = ACTIVE

2x Output: RED LED ON ☀️ = ACTIVE

Specification

Operating Temperature	-10°C to 55°C
Storage Temperature	5°C to 30°C
Humidity	Up to 95% non-condensing
Supply	6x AA Alkaline (Panasonic LR6AD Powerline / Varta 4006 Industrial)
CAUTION! Fitting of an incorrect battery type invalidates the product certification and may result in poor performance.	
Output rating	2A @ 24Vdc
IP Rating	IP65
Operating Frequency	868MHz
Output Transmitter Power	Auto adjusting 0 - 14 dBm (0 - 25 mW)
Dimensions	270mm (W) 205mm (H) 75mm (D)
Weight	0.95kg
Location	Type A: For indoor use

Regulatory Information

Manufacturer	EMS Ltd. Technology House, Herne Bay, Kent, CT6 8JZ, United Kingdom
Year of manufacture	See devices serial number label
Certification	CE 14
Certification body	0359
CPR Certificate DOP	0359-CPR-00436
Approved to	EN54-18:2005. Fire detection and fire alarm systems. Part 18: Input/output devices. EN54-25:2008. Incorporating corrigenda September 2010 and March 2012. Fire detection and fire alarm systems. Part 25: Components using radio links.
European Union directives	EMS declares that the radio equipment type Zone Interface Module is in compliance with Directive 2014/53/EU. The full text of the EU declaration of conformity is available at the following internet address: www.emsgroup.co.uk
	2012/19/EU (WEEE directive): Products marked with this symbol cannot be disposed of as unsorted municipal waste in the European Union. For recycling, return this product to your local supplier upon purchase of equivalent new equipment, or dispose of it at designated collection points. For more information see www.recyclethis.info Dispose of your batteries in an environmentally friendly manner according to your local regulations.