



7000
iris+

7258 UHF Remote Receiver



Operating Instructions

Contents

Introduction	3
Wiring Details	3
Tools & Test Equipment	5
Remote Receiver Positioning	5
Electrical Installation	5
Software Configuration	6
Iris+ Main Menu	6
Main Iris+ Receiver Software Configuration	7
Testing the System	9
Measuring the Background Level	9
On-site Range Testing	10
Site Testing with a Pager	10
Site Testing (Single Person)	11
Site Testing (Two Person)	12
Commissioning & Programming	13
Wiring	14

Introduction

The Remote Receiver for the Iris+ is designed to extend the systems wireless coverage. This is usually necessary where the premises to be protected occupies a large area, is spread over many floors or is in an area which is subject to high levels of radio interference.

The Remote Receiver units are all coded to allow individual identification. This code number (3-31) can be located on the rear of the unit and also internally. When adding additional Remote Receivers to a site, the existing receiver code numbers can be viewed from the Iris receivers menu structure. For a step by step guide to viewing the devices code numbers, refer to the 'Main Iris+ Receiver Software Configuration' section.

Important Note:

Before commencing the installation, check that all Receivers which are to be connected to the Iris+ have different NUA code numbers from any other new / existing Remote Receivers, to ensure correct operation.

The Remote Receiver is hardwired to the Iris+ using screened 4 core cable. Up to 28 Remote Receivers can be connected to the Iris+. The presence of one or more Remote Receivers is transparent to the user.

Wiring Details

The Remote Receivers and the Iris+ must be wired together in a daisy chin style. The Iris+ can be positioned anywhere along this cable run. Under no circumstances should the units be wired in a star configuration. The maximum overall cable run for the RS485 Bus is 1000 metres. A block diagram showing examples of correct / incorrect Remote Receiver wiring is shown overleaf in Figure 1.

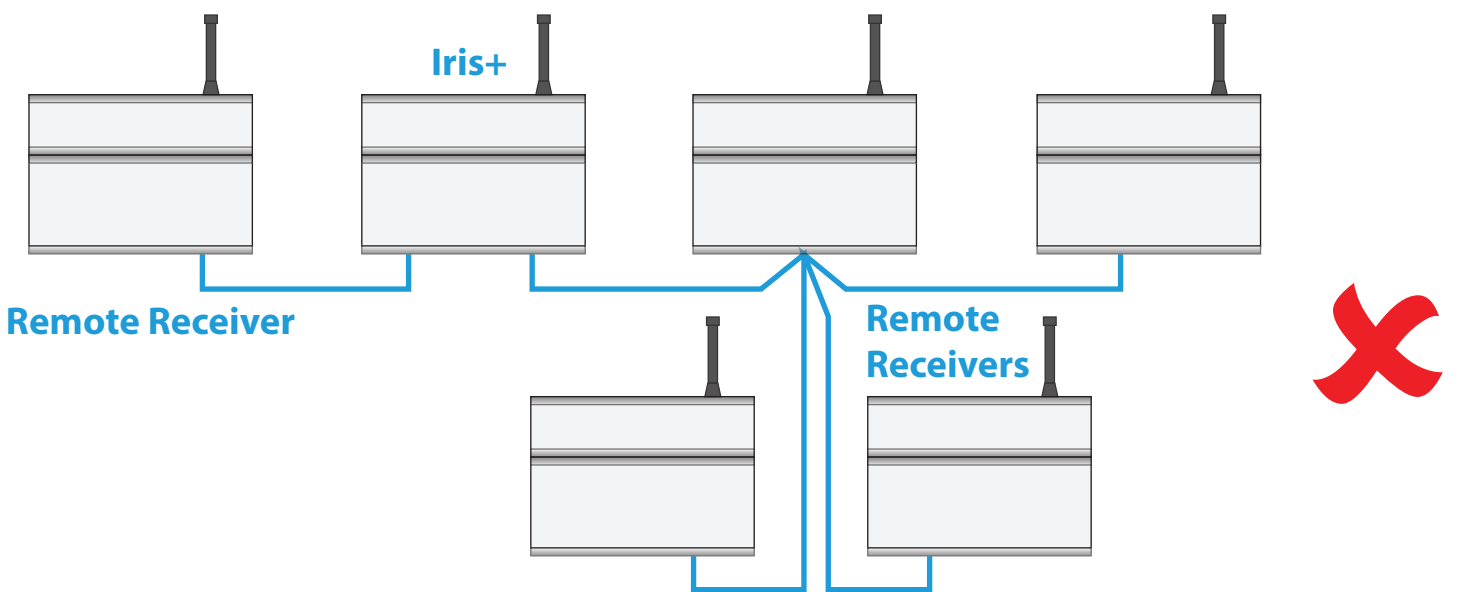
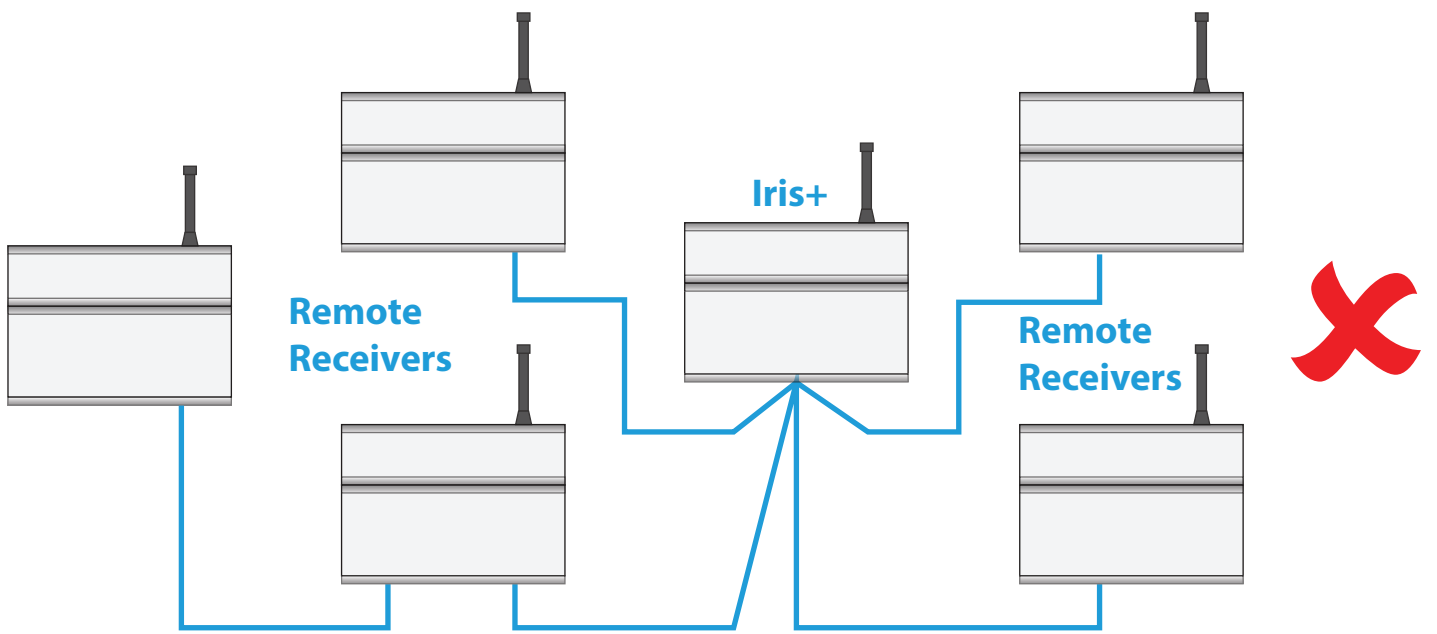
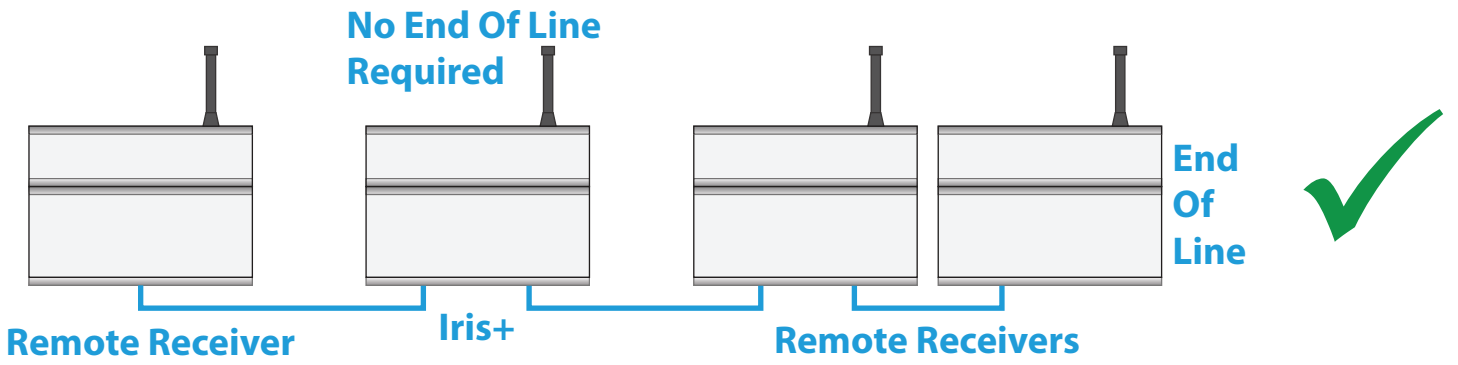
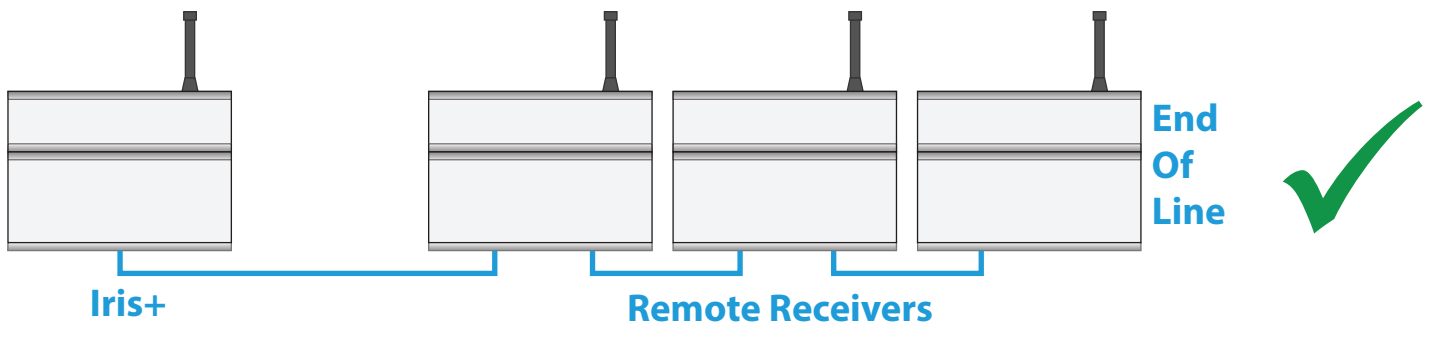

Figure 1

Tools & Test Equipment

No special test equipment is needed when installing the Remote Receiver. Only standard hand tools are required to install and commission the wireless system. Beldon four core screened cable is recommended for the connection between Remote Receivers and the Iris+ Receiver. It is also recommended that the Iris+ Engineers Programming Manual is available when commissioning a remote receiver.

Remote Receiver Positioning

The maximum range between a Remote Receiver and any transmitter is dependant upon the local environment. A range of up to 250 metres can be obtained although actual range achieved is determined by site conditions, the quality of the receivers aerial and how well the system has been installed.

When selecting a site for the receiver, the installing engineer should be aware that the aerial should be as far as away from electrical / electronic equipment as possible and a minimum of 2 metres from any such equipment. The systems performance will be reduced if the aerial is closer and will also be reduced by metal objects such as filing cabinets, pipe work, radiators and air conditioning ducts obstructing the aerial.

Electrical Installation

The Iris+ Receiver and Remote Receivers are supplied with a connection back box and should be wired as shown on page 14.

The Remote Receiver must NOT be used as a junction box or cable termination point for other equipment as this will adversely effect performance of the system. Only those cables needed to make the Remote Receiver function should be fed into the connection back box.

The Remote Receiver case must be earthed. An earthing tag is provided for this purpose. A tag is located in the connection back box of the Iris+ Receiver. The Iris+ Receiver and Remote Receivers require a 12Vdc supply. The 0V line should NOT be connected to the same point as the earth case.

Ensure that the END OF BUS jumper is made on the first and last receiver in the wiring daisy chain (See page 4 for further details). The end of bus jumper can be found on the 2411 PCB, located at the rear of the Iris+ and Remote Receivers door assembly. The jumper is located top centre of the PCB.

The RS485 port is used as the Remote Receiver Bus. The maximum overall cable run is 1000 metres.

Having installed the Iris+ Receiver and Remote Receivers, it is necessary to programme the Iris+ Receiver to communicate with the Remote Receivers. If the Iris+ Receiver and the Remote Receivers were supplied as a system, they will be pre-programmed. If however the Remote Receiver has been ordered and supplied separately, then the system will need to be configured. This configuration should always be checked (see below).

Software Configuration

To allow the Iris+ Receiver to communicate with the Remote Receivers, the Iris+ will have to be programmed to re-scan it's RS485 Bus. This action will locate all Remote Receivers on the Bus by identifying their code numbers and allow data received by each Remote Receiver to be passed to the Iris+ Receiver. If the Iris+ Receiver and Remote Receivers have been supplied as a system, then the Iris+ Receiver will have these functions pro-programmed. It is good practice to check that the settings are correct.

The relevant menu options are highlighted below in Figure 2. The programming requirements are shown in a step by step format in the following sections.

Iris+ Main Menu

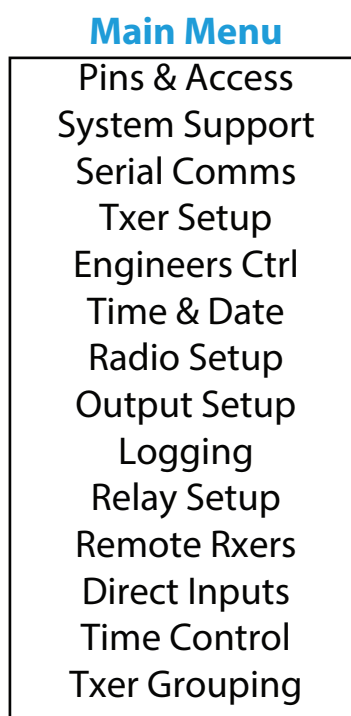



Figure 2

The Main Menu can be scrolled through using the  &  keys on the front keypad of the Iris+ Receiver.

Main Iris+ Receiver Software Configuration

Enter the Engineers Mode by turning the key to RESET and entering the engineering PIN (221100). The Iris+ Receiver's menu structure is shown below in Figure 3.

Iris+ Receiver's Menu Structure

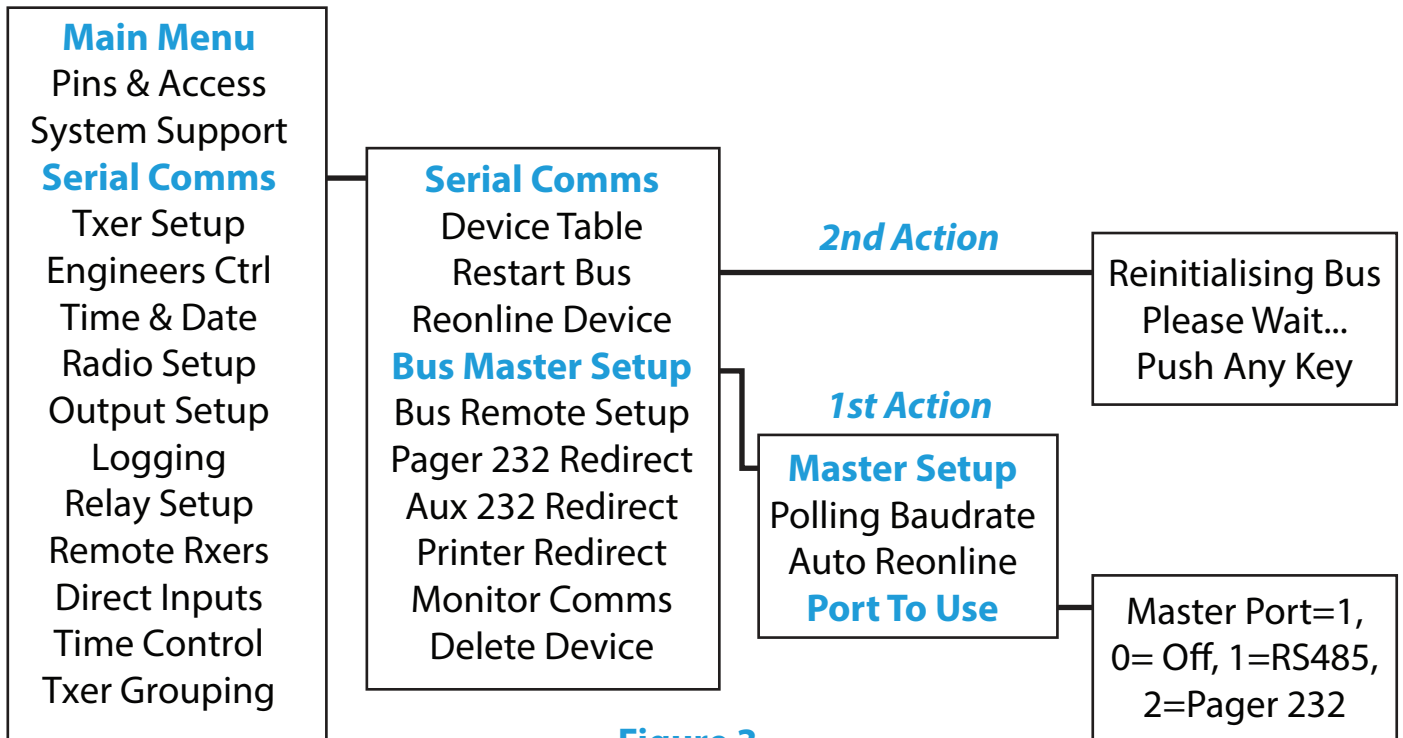

Figure 3

From the Iris+ Receiver's Main Menu:

- Use the & keys to scroll through the menu, until **>Serial Comms<** is highlighted.
- Press the key, to select.
- Use the & keys to scroll through the menu, until **>Bus Master Setup<** is highlighted.
- Press the key, to select.
- Use the & keys to scroll through the menu, until **>Port To Use<** is highlighted.
- Press the key, to select. *The following screen prompt will be displayed:*

```
Master Port=0,  
0= Off, 1=RS485,  
2=Pager 232 > _  
^ =Done v =Del 14:29
```

Figure 4

- Press the (1) key, to change the Master Port to 1, then press the (▲) key to confirm selection. This port number selects which of the output ports is used to be used for the hardwired connection between the Remote Receiver and the Iris+ Receiver.
 - Press the (3) key once to return to the Serial Comms menu. Use the (▼) & (▲) keys to scroll through the menu, until >Restart Bus< is displayed.
 - Press the (1) key, to select. This will initialise and restart the data bus that the Remote Receivers are connected to. Press the (3) key when 'done' is shown.
 - Use the (▼) & (▲) keys to scroll through the menu, until >Device Table< is highlighted.
- Press the (1) key, to select. The Remote Receivers connected to the system can now be viewed. Use the (▼) key to scroll through the display to check that the Remote Receivers are online. A typical display is shown in Figure 5.

03/Remote	
Receiver, ONLINE	
(0,00)	
2=Help	14:29

'Where '03' is the Remote Receivers NUA code number.'

Figure 5

- Press the (3) key once to return to the Serial Comms menu. Use the (▼) & (▲) keys to scroll through the menu, until >Monitor Comms< is displayed.
- Press the (1) key, to select. A typical display is shown in Figure 6.

HEAP 00	AUX=00	PGR=00
REM 000	MAS 000	T00-00
I 00	L 00	R 00
S 00	C 00	
Push Any Key		14:29

Figure 6

- The two relevant indicators for the monitoring of the RS485 Bus are described below:

MAS xxx	The number of polls per second , from the Iris+ Receiver.	If there is one Remote Receiver communicating on the RS485 Bus, the figure will be 10. If there are two Remote Receivers communicating on the RS485 Bus, the figure will be 20 and so on.
Txx - dd	xx is the number of Bus Master Timeouts that have occurred and dd is the last device to time out.	A time out is where Comms between the Iris+ Receiver and the Remote Receiver is lost momentarily.

If the system is not performing as expected in terms of range, monitoring the Comms between the Iris+ Receiver and the Remote Receivers may well indicate a connection problem. For example, a large number of Time-outs by a particular Remote Receiver, indicates a poor connection, poor screening, or the cable passing near enough to a data cable to introduce interference on the Bus. For correct communication, the amount of time-outs generated by any Remote Receiver must be less than one minute. To check the amount of time-outs generated, it is necessary to view the 'Monitor Comms' display as previously outlined, for this time period.

Testing the System

Once the Iris+ and Remote Receivers have been installed, the transmitters should be tested to ensure sitewide coverage is achieved. Each test transmission received by the system will have a signal strength value, up to a maximum value of 255. To ensure satisfactory communication, the transmitters signal strength should exceed the Background Level on the Iris+ by 30.

Measuring the Background Level

To measure the Background Interference Level on the Iris+, the following steps will need to be carried out. Turn the Iris+ control key to the Reset Position. Press the **0** key and enter the engineers pin number to access the Main Menu.

From the Main Menu:

- Use the **▼** & **▲** keys to scroll through the menu, until **>Radio Setup<** is highlighted.
- Press the **1** key, to select.
- Use the **▼** & **▲** keys to scroll through the menu, until **>Test Routines<** is highlighted.
- Press the **1** key, to select.
- Use the **▼** & **▲** keys to scroll through the menu, until **>Monitor Carrier<** is highlighted.
- Press the **1** key, to select.

A typical carrier display is shown below. See the Iris+ Instructions for further information if required.

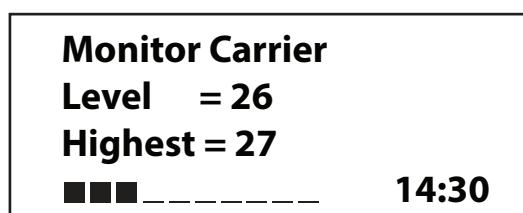

Figure 7

- Press the **3** key to back out of the menu structure.

Example 1. Transmitter test transmission signal strength value
Iris+ Background Interference Level

$$\begin{array}{r} 150 \\ - 45 \\ \hline 105 \end{array} \quad \checkmark \text{ OK}$$

Example 2. Transmitter test transmission signal strength value
Iris+ Background Interference Level

$$\begin{array}{r} 65 \\ - 45 \\ \hline 20 \end{array} \quad ! \text{ Suspect}$$

Therefore, as 20 is less than 30, the signal strength is suspect and reception of signal may be marginal.

On-site Range Testing

The method of fully testing the system is dependant upon the facilities available to the commissioning engineers carrying out the range test.

If a paging system is linked to the Iris+ Receiver, full coverage testing can be carried out by one person with a pager receiver.

If the paging option is not available it would be necessary to re-visit the Iris+ Receiver after each transmission or communicate back to a colleague situated at the Iris+, using two way radio etc. to check the signal has been received.

Site Testing with a Pager

To test the system with the availability of on-site paging, the following steps should be taken:

- On the Iris+ Receiver, turn the Control Key to the 'Test' position.
- Turn the Pager Receiver On.
- Generate an alarm transmission from the transmitter (push top button for example)
- The pager receiver should now receive a signal. An example of a received test message is shown in the following display:

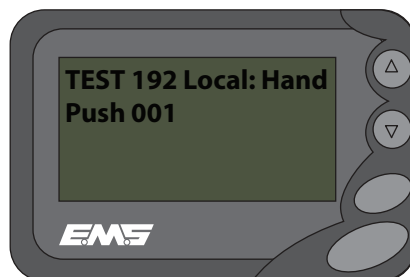

- The 192 example number shown is the signal strength, received by the Iris+ Receiver from the transmitter at its tested position. (Maximum reading available is 255).
- This number should be noted along with the position of the transmitter for future reference.
- Continue the testing until signal strength readings have been successfully taken from all points of required coverage. Return the Iris+ Control Key to the 'Clear Position' on completed tests.

Site Testing (Single Person)

For one person to test the system without the availability of onsite paging, the following steps should be carried out:

- On the Iris+ Receiver, turn the Control Key to the 'TEST' position.
- Generate a transmission from the transmitter (push top button for example).
- The Iris+ Receiver should now receive a signal. An example of a received test transmission is shown in the following display:

Hand Push 001	TEST
	192
Local	
^ to END	14:31

Note: On an activation, the transmitter actually sends three transmission bursts. This will be seen by the signal strength reading number varying accompanied by a short buzzer for each transmission. If a transmission is seen by two receivers on the system i.e. Iris+ Receiver and a Remote Receiver, or even two separate Remote Receivers, the test signals displayed will be updated in quick succession. The highest value seen should be noted. The value shown is not able to identify which receiver has actually received the signal. If this method of testing is required, refer to page 13.

- The 192 example shown is the signal strength received by the Iris+ receiver from the transmitter at its tested position. Maximum reading available is 255.
- Return to the Iris+ Receiver and note this number along with the position of the transmitter for future reference.
- Continue the testing until the signal strength readings have been successfully taken from all points of required site coverage. Return the Iris+ Control key to the 'Clear' position on completion of tests.

Site Testing (Two Person)

If a two way radio is available, one person will need to stay at the Iris+ Receiver, whilst the second will be required to carry out the following steps:

- One the Iris+ Receiver, turn the Control key to the 'Test' Position.
- Generate a transmission from the transmitter (push the top button for example)
- The Iris+ Receiver should now receive the signal. An example of a received test is shown on the following display:

Hand Push 001	TEST
	192
Local	
^ to END	14:31

Note: On an activation, the transmitter actually sends three transmission bursts. This will be seen by the signal strength reading number varying accompanied by a short buzzer for each transmission. If a transmission is seen by two receivers on the system i.e. Iris+ Receiver and a Remote Receiver, or even two separate Remote Receivers, the test signals displayed will be updated in quick succession. The highest value seen should be noted. The value shown is not able to identify which receiver has actually received the signal. If this method of testing is required, refer to page 13.

- The 192 example shown is the signal strength received by the Iris+ receiver from the transmitter at its tested position. Maximum reading available is 255.
- Speak to colleague and ask for the new signal value. Note this number along with the position of the transmitter for future reference.
- Continue the testing until the signal strength readings have been successfully taken from all points of required site coverage. Return the Iris+ Control key to the 'Clear' position on completion of tests.

If the required range is not achieved, the following options are available:

1	Fit a high gain UHF antenna to the nearest receiver.	EMS Part no 7328
2	Add additional Remote Receiver	EMS Part no 7258
3	Shift the position of a high gain antenna to a maximum of 20m away from the receiver using RG213 low loss co-axial cable.	
4	Move the nearest receiver to a more favourable position, away from the likely source of interference.	

Intimate testing of the system which requires the mapping of coverage areas for each Remote Receiver is achievable. This will require the disconnecting of the aerial connector for all other receivers than the one to be tested. Then return to the 'On-Site Range Testing' section on page 10, and plot the readings for the individual receiver.

This will need to be repeated for each receiver in turn until a full coverage map is formed. It is recommended that areas of coverage overlap as shown in the example below.

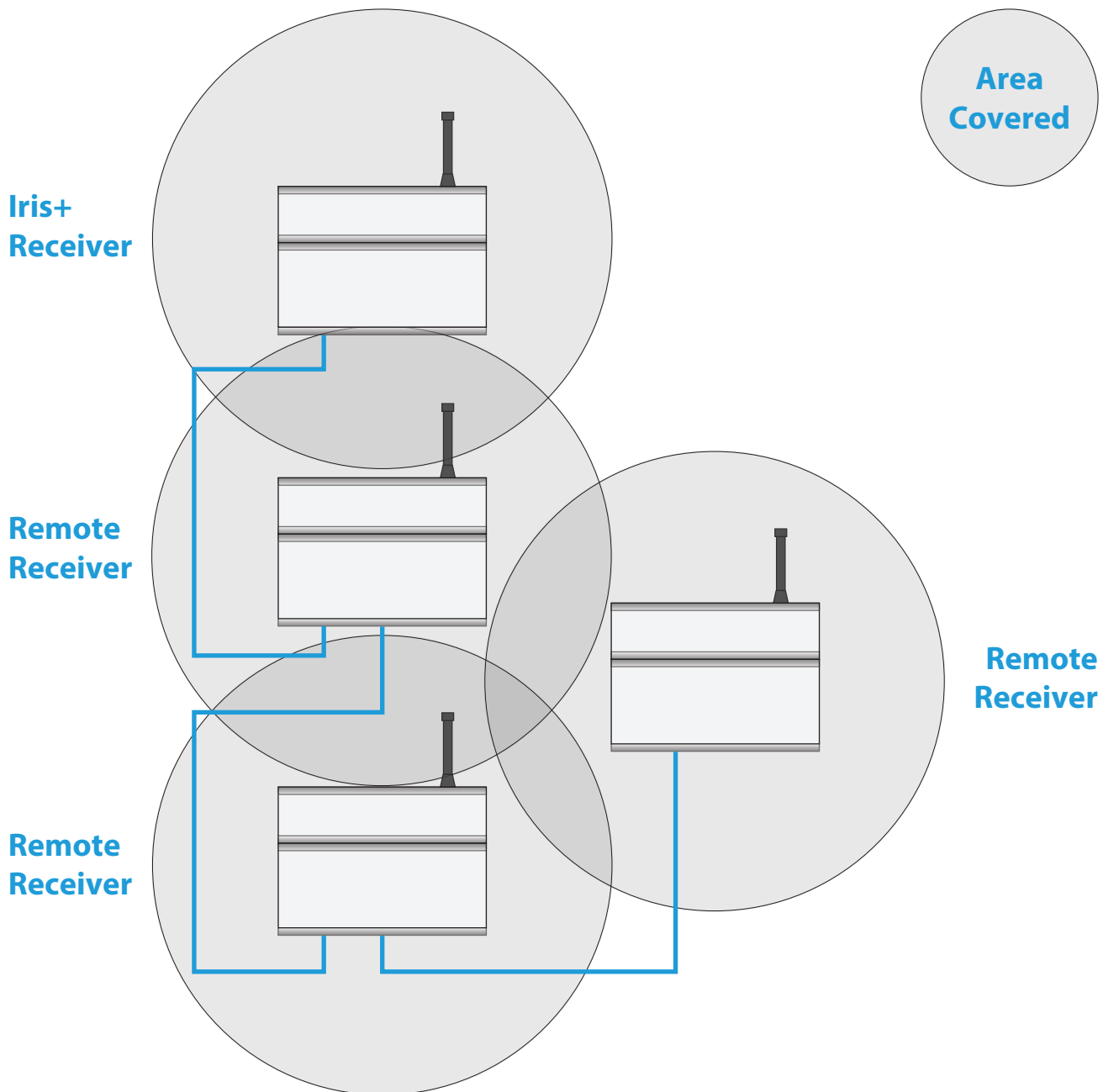

Commissioning & Programming

The Iris+ Receiver is pre-configured before leaving the factory. A computer print out is included with the equipment, showing the setup of the system. Should it be necessary to alter the setup, consult the programming guide for details on how to reprogram the Iris+ Receiver.

Wiring

Remote Receiver Back

To Next Remote Receiver (IN)

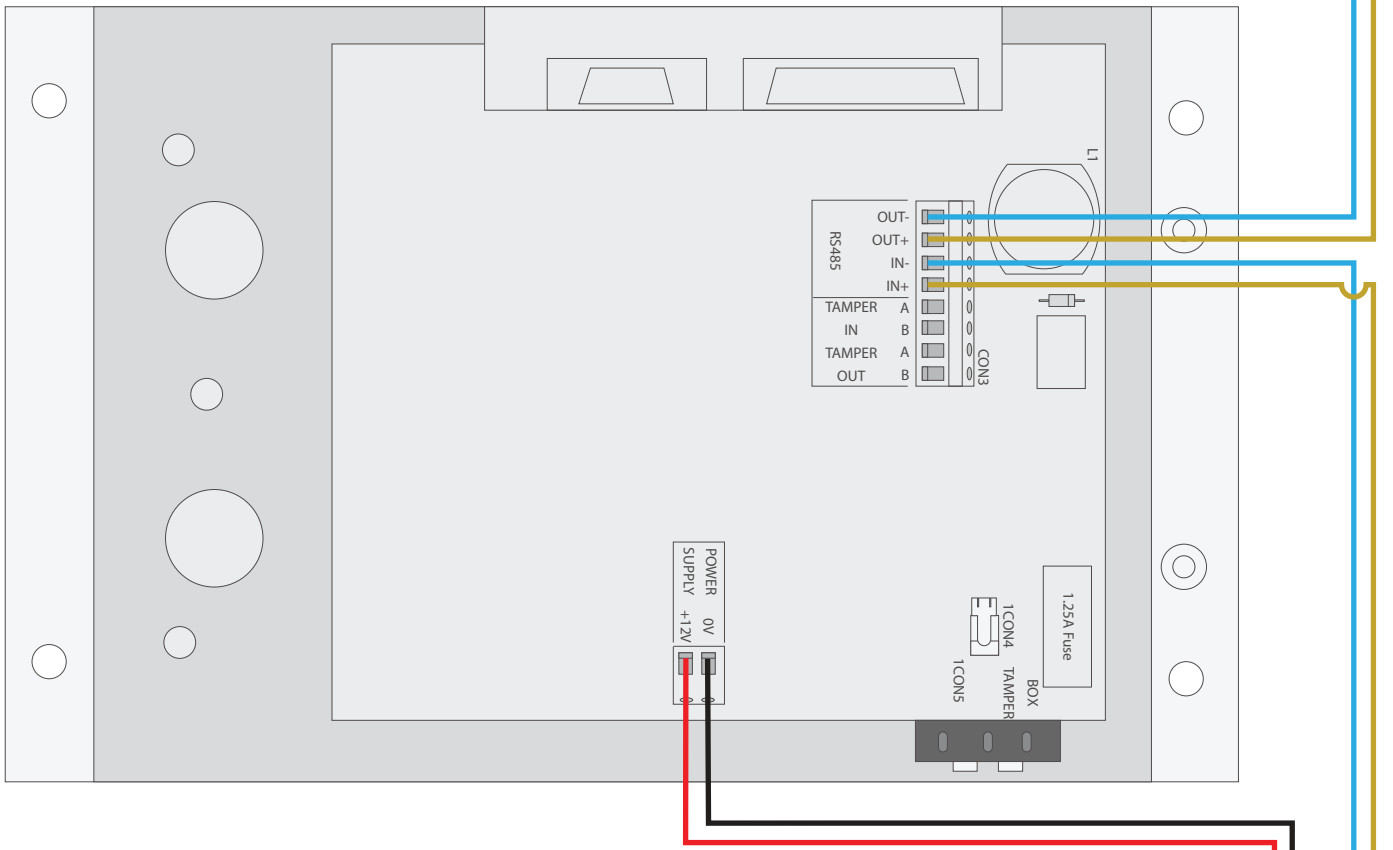

Iris+ Receiver Back box

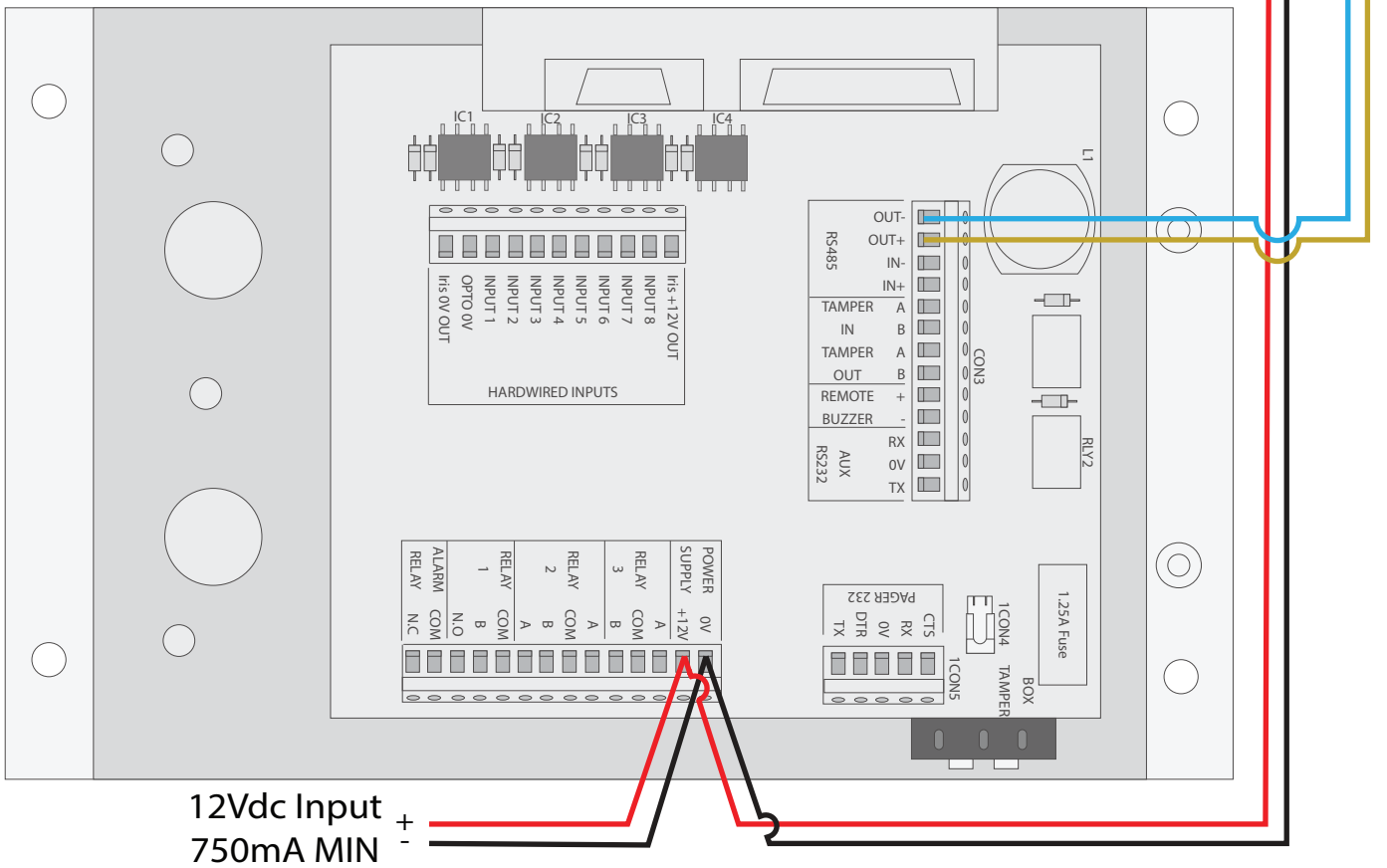



EMS Ltd.
Technology House
Sea Street, Herne Bay,
Kent, CT6 8JZ.

t: +44 (0) 1227 369570

f: +44 (0) 1227 369679

www.emsgroup.co.uk