

## Introduction

The UHF Contact Operated Transmitter works in conjunction with the 7256 Iris+ wireless receiver. The transmitter operates on UHF 458 MHz with a maximum power output of 1mW. The transmitters input can be wired as either normally closed (N/C) or normally open (N/O). Alarm signals are generated at each change of state of the transmitter input.

## Device Unlocking

Inserting the key inserted as shown to slide the wall mounting/connection plate from the device. Retain the key for future use. See Figure 1.

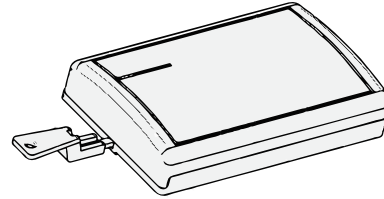

**Figure 1**

## Cable Entry

Both circled cable access points on the rear and via the top knockout are available. See Figure 2

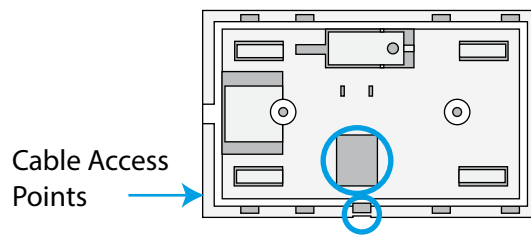

**Figure 2**

## Wall Mounting

The Wall mounting/connection plate should be screwed to the wall using suitable fasteners and fixings. Ensure the tamper knockout is cut from the moulding and screwed to the wall, for rear tamper protection. See Figure 3.

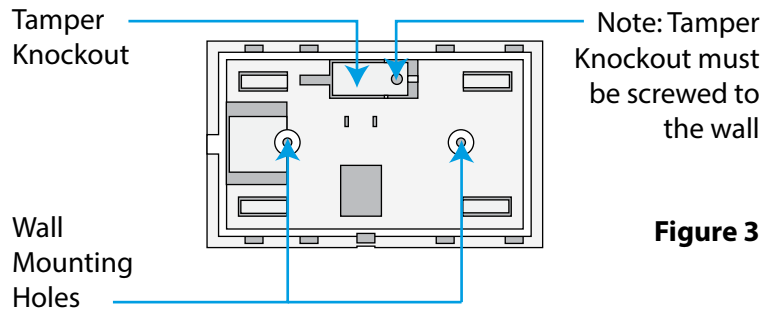

**Figure 3**

## Wiring

Figure 4 shows the transmitter's resistor monitored input. The input monitors; closed (alarm), open and short circuit conditions and the input is factory fitted with an end of line 4k7Ω resistor.

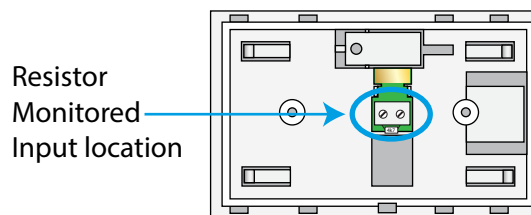

**Figure 4**

To connect the input to external devices, wire as shown using the resistor pack provided. See Figure 5

Resistor colours:  
 2k2 = Red Red Red  
 4k7 = Yellow Red Violet

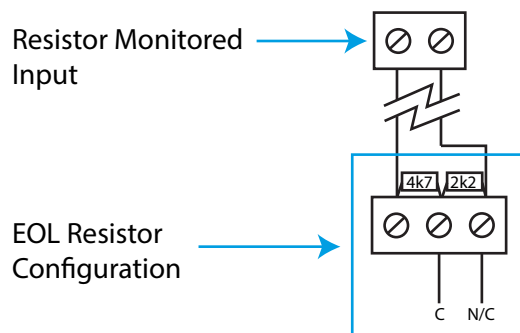

**Figure 5**

## Power the Device

The unit is powered by a 6V 7k67 alkaline battery.

Before fitting the unit to its wall mounting / connection plate, ensure the 6v battery is connected into the battery compartment as shown in Figure 6.

When fitting the transmitter into its bracket, ensure that it is clipped firmly into position. A click should be heard once the unit is installed into the bracket.

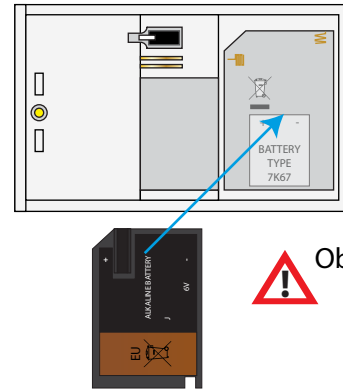

Figure 6

## Device Testing

The contact transmitter's terminal connections can be tested without the use of the main receiver.

Press and release the test button, shown in Figure 7.

The red light will flash on the front of the unit to indicate test mode. See Figure 8.

Operation of the contact will make the light flash at a different rate, confirming the correct connectivity.

The unit will automatically return to normal mode of operation after a minute.

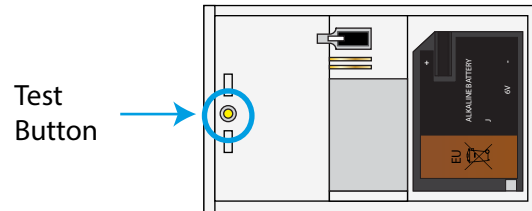

Figure 7

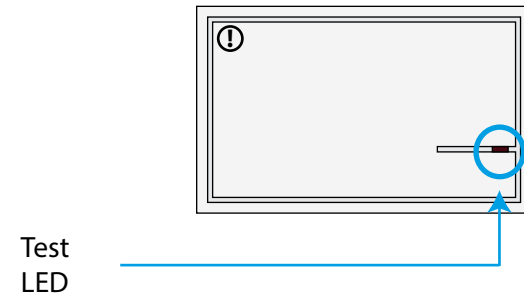

Figure 8

## Battery Replacement

Average battery life is 12 months (dependant on usage).

After replacing the batteries, it is recommended that the device is tested to ensure correct operation.



**Third Party Accredited**  
ISO 9001 ■ ISO 13485 ■ ISO 14001

The information contained within this literature is correct at time of publishing. The EMS Security Group Ltd reserves the right to change any information regarding products as part of its continual development enhancing new technology and reliability. The EMS Group advises that any product literature issue numbers are checked with its head office prior to any formal specification being written.