

FCX-175-001	Heat A1R Detector Only
FCX-176-001	Heat CS Detector Only
FCX-177-001	Optical Smoke Detector Only
FCX-194-000	Sounder/Detector Base Only
FCX-194-200	Sounder/Detector/Red Visual Indicator Base Only

## Combined Sounder/Detector/Visual Indicator with European tones Installation Guide

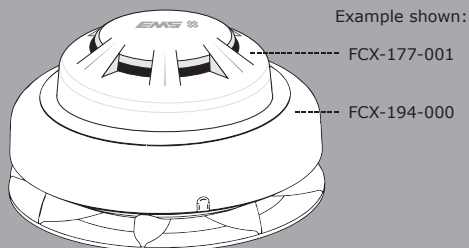

See the Specification section for compliance information.

### 1 Pre Installation



Installation must conform to applicable local installation codes and should only be installed by a fully trained competent person.

- Ensure that the device is installed as per the site survey.
- The use of a non-metallic spacer should be considered if mounting the device on to a metal surface.
- Do NOT Press the Log On button on a pre-programmed device, as this will cause communication with the Control Panel to be lost. Should this happen, delete the device from the system and add it back on.

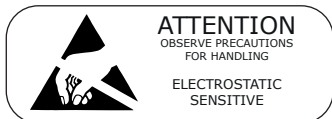

### 2 Components

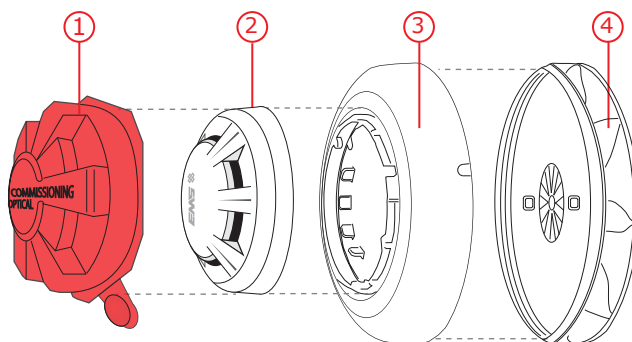

① Dust Cover ② Detector ③ Wireless Module ④ Mounting Plate

### 3 Fix Mounting Plate

Remove the mounting plate from the wireless module by turning it anticlockwise.

- Use both mounting holes to ensure a firm fixing.
- Use suitable fasteners and fixings.

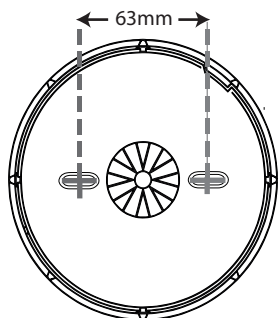
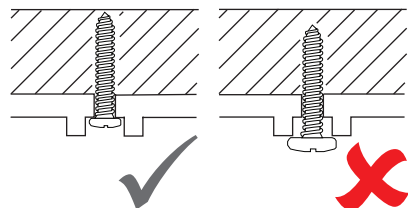

### 4 Power Device

- When fitting / replacing batteries; observe correct polarity, using only specified batteries.
- Set switch 1 to the ON position to power the device. See the configuration section for other available switch settings.

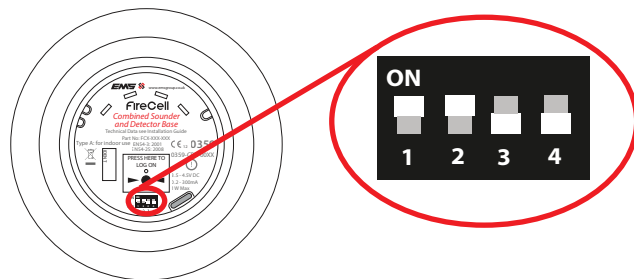

- Once powered, reassemble the device.

### 5 Optional Device Locking

- To lock the detector into the wireless module, remove the cut out (shaded) section as shown.
- To unlock the detector, insert a 1.5mm Allen key and lever the Allen key towards the outside of the device and turn the detector anticlockwise to release.
- The wireless module can also be locked into the mounting plate by removing the shaded section shown and fitting a 5/16 Phillips pan head screw.

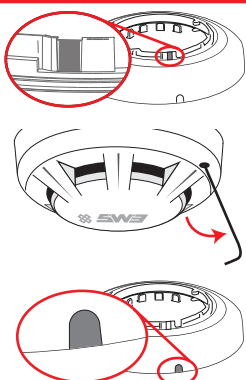

### 6 Configuration

The device's loop address is configured within the menu structure of the Radio Hub.

- Refer to the programming manual (Doc Ref: MK98) for full programming information.



Free to download from [www.emsgroup.co.uk](http://www.emsgroup.co.uk)

## Configuration Continued

### Device Powering/Sounder Volume (Set on Wireless Module)

Switches 1-2 on the 4 way switch are used to power the device and to change the sounder volume.

Default Setting: Supplied unpowered with high sounder volume.

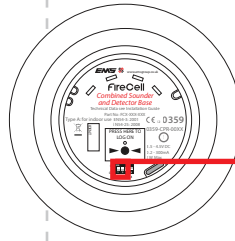

SWITCHES 1 & 2	DEVICE POWERED?	SOUNDER VOLUME
ON  ON	✓	HIGH 97dB A (+/- 1dB)
ON  OFF	✓	LOW 71 dB A (+/- 1dB)
OFF  ON	✗	HIGH 97dB A (+/- 1dB)
OFF  OFF	✗	LOW 71 dB A (+/- 1dB)

### Sounder Tone \* (Set on Wireless Module)

Switches 3-4 on the 4 way switch are used to configure the sounder tone.

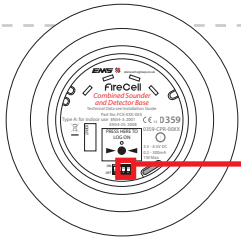

SWITCHES 3 & 4	PRIMARY TONE	TONE TYPE	TONE DESCRIPTION / APPLICATION	SECONDARY TONE	TONE TYPE	TONE DESCRIPTION / APPLICATION
ON  OFF	13		1200Hz - 500Hz @ 1Hz	1		970Hz
OFF  ON	1		970Hz	18		2400Hz
ON  ON	5		970Hz, 0.5s/ 630Hz, 0.5s	4		970Hz 1s OFF / 1s ON
OFF  OFF	7		500 - 1200Hz, 3.5s/ 0.5s OFF	1		970Hz

Default Setting: Primary Tone 7

## IMPORTANT

- Remove dust cover before use.
- The device should be tested upon installation and in accordance with local requirements.
- Testing should only be carried out by a fully trained competent person.

- The Manufacturer recommends regular functional testing of at least once per annum or in accordance with local codes of practice.
- Cleaning and repairs must be undertaken by the Manufacturers authorised representative.
- Do not open the case to clean inside the detector.

## Specification

<b>Operating Temperature</b>	-10°C to 55°C
<b>Storage Temperature</b>	5°C to 30°C
<b>Humidity</b>	Up to 95% non-condensing
<b>Supply</b>	3x AA Alkaline (Panasonic LR6AD Powerline / Varta 4006 Industrial) & 3x C Alkaline (Panasonic LR14AD Powerline / Varta 4014 Industrial)
CAUTION! Fitting of an incorrect battery type invalidates the product certification and may result in poor performance.	
<b>IP Rating</b>	IP23
<b>Operating Frequency</b>	868MHz
<b>Output Transmitter Power</b>	Auto adjusting 0 - 14 dBm (0 - 25 mW)
<b>Sounder Output</b>	97dB(A) @ 1m (as dispatched). Low setting reduces volume by 26dB.  Refer to the sounder data document (MK187) for full details. <i>Free to download from <a href="http://www.emsgroup.co.uk">www.emsgroup.co.uk</a></i>
<b>Dimensions</b>	146mm (Ø) x 53mm (D) (No detector) 146mm (Ø) x 94mm (D) (with detector)
<b>Weight</b>	0.70kg (with detector)
<b>Location</b>	Type A: For indoor use

## Regulatory Information

<b>Manufacturer</b>	EMS Security Group Ltd. Technology House, Herne Bay, Kent, CT6 8JZ, United Kingdom
<b>Year of manufacture</b>	See devices serial number label
<b>Certification</b>	CE 12
<b>Certification body</b>	0359
<b>CPR Certificate DOP</b>	See part listing for associated products: [1]0359-CPR-0015, [2]0359-CPR-0017, [3]0359-CPR-0121
<b>Approved to</b>	See part listing for associated products: EN54-3:2001. Incorporating Amendments Nos. 1 and 2. Fire detection and fire alarm systems. Part 3: Fire alarm devices - Sounders. [3] EN54-5:2001. Incorporating Amendment No. 1. Fire detection and fire alarm systems. Part 5: Heat detectors - Point Detectors. [1] EN54-7:2001. Incorporating Amendment No. 1. Fire detection and fire alarm systems. Part 7: Smoke detectors - Point detectors using scattered light, transmitted light or ionization. [2] EN54-25:2008. Incorporating corrigenda September 2010 and March 2012. Fire detection and fire alarm systems. Part 25: Components using radio links. [3]
<b>European Union directives</b>	EMS Security Group Ltd hereby declares that this device is in compliance with the essential requirements and other relevant provisions of Directive 2014/53/EU (R&TTE directive).



2012/19/EU (WEEE directive): Products marked with this symbol cannot be disposed of as unsorted municipal waste in the European Union. For proper recycling, return this product to your local supplier upon purchase of equivalent new equipment, or dispose of it at designated collection points. For more information see [www.recyclethis.info](http://www.recyclethis.info)  
Dispose of your batteries in an environmentally friendly manner according to your local regulations.