

FC-171-001
 FC-171-002
 FC-315-CA1
 FC-315-CA2
 FC-315-WA1
 FC-315-WA2

White Wireless Sounder Base Only
 Red Wireless Sounder Base Only
 White Ceiling Sounder Beacon Only
 Red Ceiling Sounder Beacon Only
 White Wall Sounder Beacon Only
 Red Wall Sounder Beacon Only

[2]
 [2]
 [1]
 [1]
 [1]
 [1]

Wireless Sounder Beacon Installation Guide

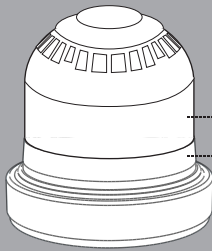

Example shown:
 FC-315-CA1
 FC-171-001

See the Specification section for compliance information.

1 Pre Installation



Installation must conform to applicable local installation codes and should only be installed by a fully trained competent person.

- Ensure that the device is installed as per the site survey.
- The use of a non-metallic spacer should be considered if mounting the device on to a metal surface.
- Do NOT Press the Log On button on a pre-programmed device, as this will cause communication with the Control Panel to be lost. Should this happen, delete the device from the system and add it back on.

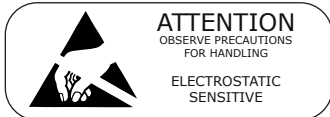

2 Components

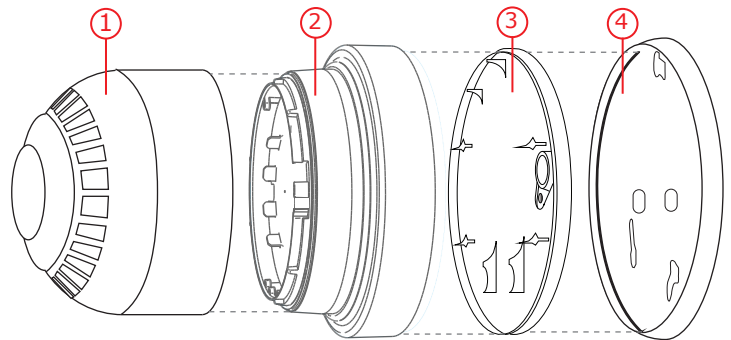

① Sounder Beacon ② Wireless Module
 ③ Battery Retaining Plate ④ Mounting Plate

3 Fix Mounting Plate

Remove the mounting plate from the wireless module by turning it anticlockwise.

- When wall mounting, ensure the mounting plate is fitted in the orientation shown.
- Use both mounting holes.
- Use suitable fasteners and fixings.

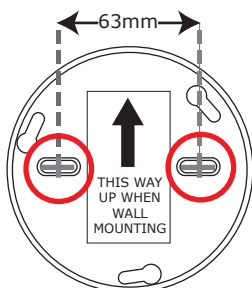
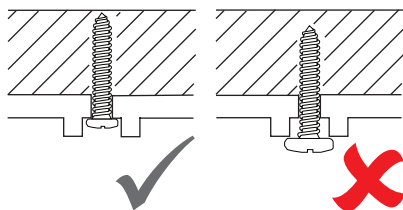

4 Power Device

- Unclip the battery retaining plate from the wireless module.
- When fitting / replacing batteries; observe correct polarity, using only specified batteries.
- Connect the power jumper across the PIN header.

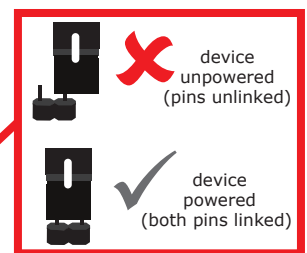
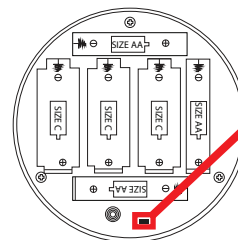

- Once powered, reassemble the device.

5 Optional Device Locking

- To lock the Sounder Beacon into the wireless module, remove the cut out section as shown.

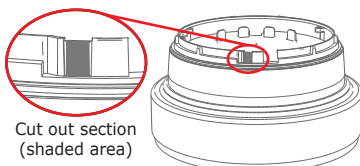

- To unlock, insert a 1.5mm Allen key to depress the locking clip and turn anticlockwise to release as shown.

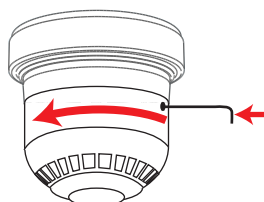

6 Configuration

The device's loop address is configured within the menu structure of the Radio Hub.

- Refer to the programming manual (Doc Ref: MK98) for full programming information.



Free to download from www.emsgroup.co.uk

Configuration Continued

Sounder Tone (Set on Sounder Beacon)

Switches 1-5 on the 7 way switch are used to configure the sounder tone.

All 32 available configurations are shown in the tone table.

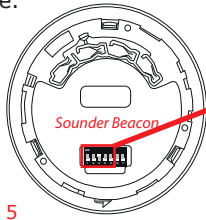

Default Setting: Primary Tone 5

Volume/Flash Rate (Set on Sounder Beacon)

Switches 6 and 7 are used to configure the volume and flash rate.

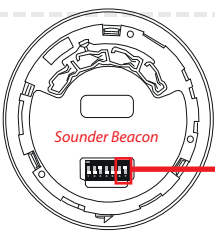

SWITCHES 6 & 7	VOLUME	FLASH RATE
ON ON	LOW	1Hz
ON OFF	LOW	0.5Hz
OFF ON	HIGH	1Hz
OFF OFF	HIGH	0.5Hz

Default setting: High Volume / 1Hz Flash Rate

Audio Monitoring (Set on Wireless Module)

The primary and secondary stage sounder tones can be monitored. If enabled and no audio is detected within 10 seconds upon sounder activation, a fault is indicated at the control panel.

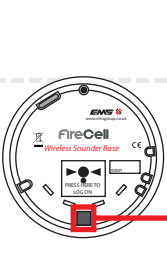

SWITCHES 1 & 2	PRIMARY TONE MONITORED	SECONDARY TONE MONITORED
ON ON	✓	✓
ON OFF	✓	✗
OFF ON	✗	✓
OFF OFF	✗	✗

Default setting: Audio Monitoring Disabled

SWITCHES 1-5	PRIMARY TONE	NEEDLE TYPE	TONE DESCRIPTION / APPLICATION	SECONDARY TONE
ON 1 2 3 4 5	1.	— — — —	970Hz	18
ON 1 2 3 4 5	2.	▄ ▄ ▄ ▄	800Hz/970Hz @ 2Hz	1
ON 1 2 3 4 5	3.	▄ ▄ ▄ ▄	800Hz - 970Hz @ 1Hz	1
ON 1 2 3 4 5	4.	- - - -	970Hz 1s OFF / 1s ON	1
ON 1 2 3 4 5	5.	▄ ▄ ▄ ▄	970Hz, 0.5s / 630Hz, 0.5s	4
ON 1 2 3 4 5	6.	▄ ▄ ▄ ▄	554Hz, 0.1s / 440Hz, 0.4s (AFNOR NF S 32 001)	1
ON 1 2 3 4 5	7.	▄ ▄ ▄	500 - 1200Hz, 3.5s / 0.5s OFF (NEN 2575:2000)	1
ON 1 2 3 4 5	8.	- - - -	420Hz 0.625s ON / 0.625s OFF (Australia AS1670 Alert tone)	9
ON 1 2 3 4 5	9.	▄ ▄ ▄	500 - 1200Hz, 0.5s / 0.5s OFF x 3 / 1.5s OFF (AS1670 Evacuation)	1
ON 1 2 3 4 5	10.	▄ ▄ ▄ ▄	550Hz / 440Hz @ 0.5Hz	19
ON 1 2 3 4 5	11.	- - - -	970Hz, 0.5 ON / 0.5s OFF x 3 / 1.5s OFF (ISO 8201)	1
ON 1 2 3 4 5	12.	- - - -	2850Hz, 0.5s ON / 0.5s OFF x 3 / 1.5s OFF (ISO 8201)	1
ON 1 2 3 4 5	13.	▄ ▄ ▄ ▄	1200Hz - 500Hz @ 1Hz (DIN 33 404)	1
ON 1 2 3 4 5	14.	— — — —	400Hz	18
ON 1 2 3 4 5	15.	▄ ▄ ▄ ▄	550Hz, 0.7s / 1000Hz, 0.33s	1
ON 1 2 3 4 5	16.	▄ ▄ ▄ ▄	1500Hz - 2700Hz @ 3Hz	1
ON 1 2 3 4 5	17.	— — — —	750Hz	1
ON 1 2 3 4 5	18.	— — — —	2400Hz	1
ON 1 2 3 4 5	19.	— — — —	660Hz	18
ON 1 2 3 4 5	20.	- - - -	660Hz 1.8s ON / 1.8s OFF	19
ON 1 2 3 4 5	21.	- - - -	660Hz 0.15s ON / 0.15s OFF	19
ON 1 2 3 4 5	22.	▄ ▄ ▄ ▄	510Hz, 0.25s / 610Hz, 0.25s	1
ON 1 2 3 4 5	23.	▄ ▄ ▄ ▄	800 / 100Hz 0.5s each (1Hz)	1
ON 1 2 3 4 5	24.	▄ ▄ ▄ ▄	250Hz - 1200Hz @ 12Hz	1
ON 1 2 3 4 5	25.	▄ ▄ ▄ ▄	500Hz - 1200Hz @ 0.33Hz	1
ON 1 2 3 4 5	26.	▄ ▄ ▄ ▄	2400Hz - 2900Hz @ 9Hz	18
ON 1 2 3 4 5	27.	▄ ▄ ▄ ▄	2400Hz - 2900Hz @ 3Hz	18
ON 1 2 3 4 5	28.	▄ ▄ ▄ ▄	800Hz - 970Hz @ 100Hz	1
ON 1 2 3 4 5	29.	▄ ▄ ▄ ▄	800Hz - 970Hz @ 9Hz	1
ON 1 2 3 4 5	30.	▄ ▄ ▄ ▄	800Hz - 970Hz @ 3Hz	1
ON 1 2 3 4 5	31.	— — — —	800Hz, 0.25s ON / 1s OFF	1
ON 1 2 3 4 5	32.	▄ ▄ ▄	500Hz - 1200Hz, 3.75s / 0.25s OFF (AS2220)	8

Specification

Operating Temperature	-10°C to 55°C
Storage Temperature	5°C to 30°C
Humidity	Up to 95% non-condensing
Supply	3x AA Alkaline (Panasonic LR6AD Powerline / Varta 4006 Industrial) 3x C Alkaline (Panasonic LR14AD Powerline / Varta 4014 Industrial)
CAUTION! Fitting of an incorrect battery type invalidates the product certification and may result in poor performance.	
Sounder Output	94-97dB(A) @ 1m (as dispatched). Low setting reduces volume by 7dB.
IP Rating	IP54
Operating Frequency	868MHz
Output Transmitter Power	Auto adjusting 0 - 14 dBm (0 - 25 mW)
Beacon Element Voltage	17-60Vdc Operating at 18Vdc
Beacon Element Max Current	45mA @ 1Hz flash rate
Flash Rate	0.5Hz/1Hz (selectable)
Beacon Coverage	C-3-15 (Ceiling mounted variant) W-3.1-11.3 (Wall mounted variant)
Dimensions	120mm (Ø) 145mm (D)
Weight	0.65kg
Location	Type A: For indoor use

Regulatory Information

Manufacturer	EMS Security Group Ltd. Technology House, Herne Bay, Kent, CT6 8JZ, United Kingdom
Year of manufacture	See devices serial number label
Certification	CE 14
Certification body	0359
CPR Certificate DOP	0359-CPR-00292
Approved to	See part listing for associated products: EN54-3:2001. Incorporating Amendments Nos. 1 and 2. Fire detection and fire alarm systems. Part 3: Fire alarm devices - Sounders. [1] EN54-23:2010. Fire detection and fire alarm systems. Part 23: Fire alarm devices. Visual alarm devices. [1] EN54-25:2008. Incorporating corrigenda September 2010 and March 2012. Fire detection and fire alarm systems. Part 25: Components using radio links. [2]
European Union directives	EMS Security Group Ltd hereby declares that this device is in compliance with the essential requirements and other relevant provisions of Directive 2014/53/EU (R&TTE directive).
	2012/19/EU (WEEE directive): Products marked with this symbol cannot be disposed of as unsorted municipal waste in the European Union. For proper recycling, return this product to your local supplier upon purchase of equivalent new equipment, or dispose of it at designated collection points. For more information see www.recyclethis.info Dispose of your batteries in an environmentally friendly manner according to your local regulations.